

Residential Air-Conditioners Catalogue

SR*series*

2026

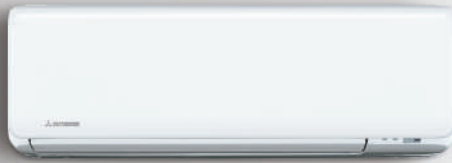

Residential Air-Conditioners

What benefits can Mitsubishi Heavy Industries Air-Conditioner offer?

- Maintains comfortable environments with quick cool-down/warm-up
- Energy saving for a sustainable future
- Innovative design suitable for all interiors
- Reliable for long term use



Design award for

Mitsubishi Heavy Industries SRK-ZSX air-conditioning unit

Mitsubishi Heavy Industries has been awarded the 2017 Silver A' Design Award in the 'Engineering and Technical Design' category for its SRK-ZSX Diamond Series air conditioning unit. It was created to meet the demanding expectations of the European air conditioning market.



CONTENTS

- INTRODUCTION	2
- PRODUCT LINE UP	4
- KEY FEATURES OF THE ZT SERIES	8
- ADVANCED TECHNOLOGY	18
- FUNCTIONS	30
- SINGLE-SPLIT	32
- WALL MOUNTED TYPE R32	32 - 40
- WALL MOUNTED TYPE R410A	44 - 47
- FLOOR STANDING TYPE	41, 48
- CEILING CONCEALED TYPE	42, 49
- 4WAY CEILING CASSETTE TYPE	43, 50
- MULTI-SPLIT SYSTEM	51
- CONTROL SYSTEM	114
- DIMENSIONS	116
- ENERGY EFFICIENT AND ENVIRONMENTALLY CONSCIOUS	127

Elegant Timeless Design

The ZSX/ZT and ZTL series air-conditioners have been innovatively designed with rounded contours that fit beautifully into Europe's diverse interior.



ZSX series



ZTL series

Quiet and Comfortable

Mitsubishi Heavy Industries Thermal Systems offers a unique discreet air-conditioner; quiet and comfortable which provides precise air flow and capacity control.



Energy Saving

High energy saving with comfort. Provides the user multiple solutions in comfort and energy savings. All the models can achieve high energy efficiency by use of Mitsubishi Heavy Industries technology, such as high performance compressor, DC PAM inverter technology.



























Convenience

Control your air-conditioner from anywhere, anytime with the optional Wireless Control System.





















PRODUCT LINE UP

■ SINGLE-SPLIT

Model		Capacity Range (kW : Rated cooling capacity)												
		1.5	2.0	2.5	3.5	4.0	4.5	5.0	6.0	6.3	7.1	8.0	10.0	
WALL MOUNTED TYPE	Diamond Series SRK-ZSX-WF SRK-ZSX-W,-S  *1	 P.32	●	●	●				●	●				
		 P.44		●	●	●			●	●				
				●	●	●								
				●	●	●								
				●	●	●								
				●	●	●								
	Diamond Series SRK-ZR-WF SRK-ZR-W,-S 	 P.34								●	●	●	●	
		 P.45								●	●	●	●	
										●	●	●	●	
										●	●	●	●	
										●	●	●	●	
										●	●	●	●	
	Premium Series SRK-ZT-WF New  *1	 P.36		●	●	●			●					
				●	●	●			●					
				●	●	●			●					
				●	●	●			●					
				●	●	●			●					
				●	●	●			●					
	Premium Series SRK-ZS-S  *1	 P.46		●	●	●			●					
				●	●	●			●					
				●	●	●			●					
				●	●	●			●					
				●	●	●			●					
				●	●	●			●					
	Standard Plus Series SRK-ZTL-W 	 P.38	●	●	●	●			●		●	●		
			●	●	●	●			●		●	●		
				●	●	●			●		●	●		
				●	●	●			●		●	●		
				●	●	●			●		●	●		
				●	●	●			●		●	●		
	Standard Series SRK-ZSP-W1 SRK-ZSP-S 	 P.40			●	●		●	●					
		 P.47			●	●		●	●					
					●	●		●	●					
					●	●		●	●					
					●	●		●	●					
					●	●		●	●					
FLOOR STANDING TYPE	SRF-ZS-W SRF-ZSX-W 	 P.41			●	●			●					
					●	●			●					
	SRF-ZMX-S 	 P.48			●	●			●					
					●	●			●					
CEILING CONCEALED TYPE	SRR-ZS-W 	 P.42			●	●			●	●				
					●	●			●	●				
	SRR-ZM-S 	 P.49			●	●								
					●	●								
CEILING CASSETTE TYPE (600x600mm)	FDTC-VH 	 P.43			●	●	●		●	●				
					●	●	●		●	●				
	FDTC-VF 	 P.50			●	●	●		●	●				
					●	●	●		●	●				

*1 ZSX, ZT, ZS colour variations available.

■ MULTI-SPLIT SYSTEM

		SCM-ZS-W  P.52								SCM-ZS-S,ZM-S  P.54									
Model (kW)		3.0	4.0	4.5	4.1	5.0	6.0	7.1	8.0	10.0	4.0	4.5	5.0	6.0	7.1	8.0	10.0	12.5	
Number of connectable indoor units		2		2 - 3			2 - 4		2 - 5		2		2 - 3		2 - 4		4 - 5 4 - 6		
Outdoor unit*1		 A+++		 A+++			 A++		 A+++		 A++		 A++		 A++		 A *2		
Indoor unit (kW)																			
WALL MOUNTED TYPE	SRK-ZSX-WF, -W 	2.0	●	●		●	●	●	●	●		●	●	●	●	●	●	●	
		2.5	●	●		●	●	●	●	●		●	●	●	●	●	●	●	●
		3.5	●	●		●	●	●	●	●		●	●	●	●	●	●	●	●
		5.0				●	●	●	●	●				●	●	●	●	●	●
		6.0						●	●	●	●				●	●	●	●	●
	SRK-ZR-WF, -W 	7.1							●	●	●							●	●
		8.0								●									
	SRK-ZS-WF, -W 	1.5	●			●													
		2.0	●	●	●	●	●	●	●	●	●	●	●	●	●	●	●	●	●
		2.5	●	●	●	●	●	●	●	●	●	●	●	●	●	●	●	●	●
3.5		●	●	●	●	●	●	●	●	●	●	●	●	●	●	●	●	●	
5.0						●	●	●	●	●				●	●	●	●	●	
SKM-ZSP-W 	1.5	●			●														
	2.0	●	●	●	●	●	●	●	●	●	●	●	●	●	●	●	●	●	
	2.5	●	●	●	●	●	●	●	●	●	●	●	●	●	●	●	●	●	
	3.5	●	●	●	●	●	●	●	●	●	●	●	●	●	●	●	●	●	
SRF-ZS(X)-W 	2.5	●	●		●	●	●	●	●	●	●	●	●	●	●	●	●	●	
	3.5	●	●		●	●	●	●	●	●	●	●	●	●	●	●	●	●	
	5.0				●	●	●	●	●	●				●	●	●	●	●	
CEILING CONCEALED TYPE SRR-ZS-W 	2.5	●	●		●	●	●	●	●	●	●	●	●	●	●	●	●	●	
	3.5	●	●		●	●	●	●	●	●	●	●	●	●	●	●	●	●	
	5.0				●	●	●	●	●	●				●	●	●	●	●	
	6.0						●	●	●	●					●	●	●	●	
CEILING CASSETTE TYPE (600x600mm) FDTC-VH 	2.5	●	●		●	●	●	●	●	●	●	●	●	●	●	●	●	●	
	3.5	●	●		●	●	●	●	●	●	●	●	●	●	●	●	●	●	
	5.0				●	●	●	●	●	●				●	●	●	●	●	
	6.0						●	●	●	●					●	●	●	●	
DUCT CONNECTED TYPE FDUM-VH 	5.0				●	●	●	●	●	●				●	●	●	●	●	
CEILING SUSPENDED TYPE FDE-VH 	5.0				●	●	●	●	●	●				●	●	●	●	●	

*1 Energy class depends on connected indoor units. *2 Energy label applies below cooling capacity 12kW. *3 Can be also connected colour variation type.

ZSX series

For more details go to P32 & 33 »



White(-WF),
Black & White(-WFB),
Titanium(-WFT)

Elegant & timeless design



ZSX series White(-WF)

ZT series

For more details go to P36 & 37 »



Pure White(-WF),
Black(-WFB),
Titanium & Black(-WFT)



A soft yet solid design



ZTL series

For more details go to P38 & 39 »

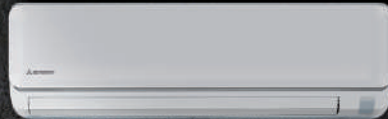

Contemporary & compact design





New
Wall mounted

ZT series

The overall design is simple and box-like, with a flat front surface that matches well with modern interiors.

The smooth front panel flows gently from the top to the front, like a soft veil.

Tapered edges soften the overall form. The front panel is precisely aligned with edge lines that extend in three directions, contributing to a polished appearance.

A soft yet solid design

A soft impression reminiscent of a veil



Design



Black
for a bold, modern look

Colour variations

The unit is available in three colour variations.
Choose the one that best suits your interior style.

Pure White

a clean, classic finish

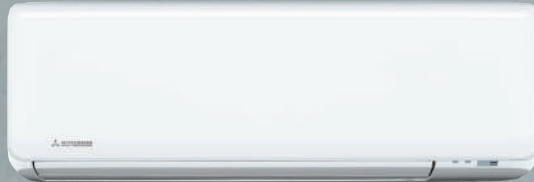

Titanium & Black

offering a sophisticated,
metallic edge

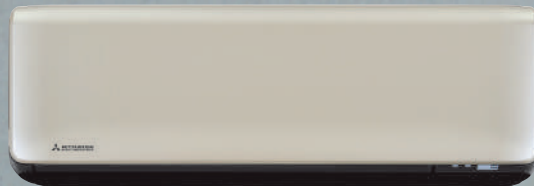

Craftsmanship in details



The screws of the unit are concealed beneath a cover, giving the unit a less mechanical and more refined, interior-oriented appearance.



One of the edges lines is aligned with the upper flap, forming a single smooth, clean line from the wall across the unit.



Jet black outdoor unit

Alongside the harmonious white that blends into its surroundings, there is now a black outdoor unit, providing a bold and sophisticated presence that enhances its surroundings.



SRC20/25/35ZT-WB



SRC50ZT-WB



SRC20/25/35ZT-W



SRC50ZT-W



Efficiency

Improved energy efficiency in a compact unit

With the refinement of components, the unit's efficiency has improved while maintaining its compact size.



SEER in cooling

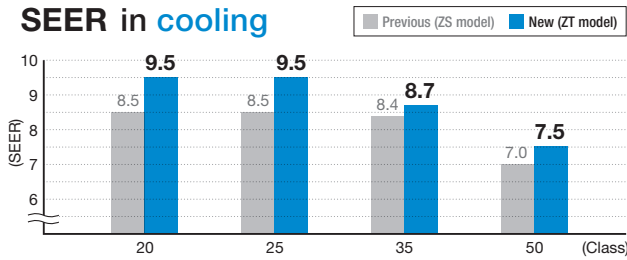

SCOP in heating

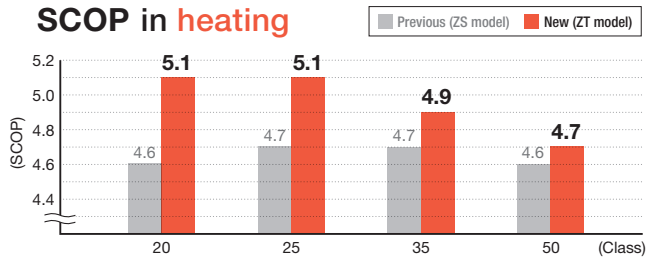

*SEER/SCOP are based on EN14825:2016 and Commission regulation (EU) No.2016/2281. Temperature conditions for calculating SCOP are based on "Average climate".

New Heat Exchanger



Indoor unit

Reduced copper tube diameter

Previous

New ZT



Outdoor unit
Ø7.45 → Ø6.35
(Only for 5.0kW Model)

More compact, but increased the total volume

for 3.5kW Model

15 rows

20 rows

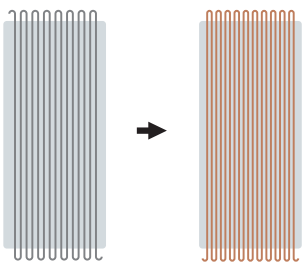

Indoor unit

By reducing the copper tube diameter from Ø6.35 to Ø5, the total number of rows in the heat exchanger has increased, effectively enlarging the contact surface area. This dense structure allows for a more compact unit size while increasing the total volume of the heat exchanger, resulting in improved efficiency.

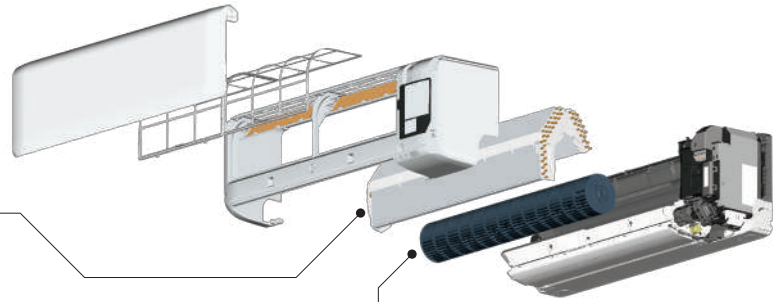

New Cross Flow Fan (Anti-microbial fan)

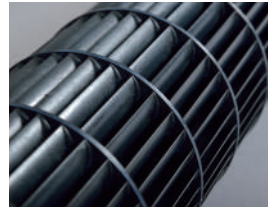

Enhanced efficiency and airflow

With the in-house engineered fan, both efficiency and airflow have been optimized. The fan's blade shape and angle were determined after testing hundreds of combinations, resulting in improved overall performance and enhanced airflow.

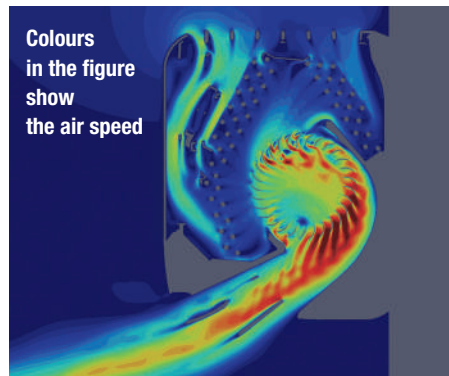

Colours in the figure show the air speed
Slow Fast

Comfort

Compact unit, with long reach / 11m*

By adopting a new air outlet design, the airflow of the indoor unit can reach up to 11m, allowing for a more powerful and efficient distribution of cool or warm air.

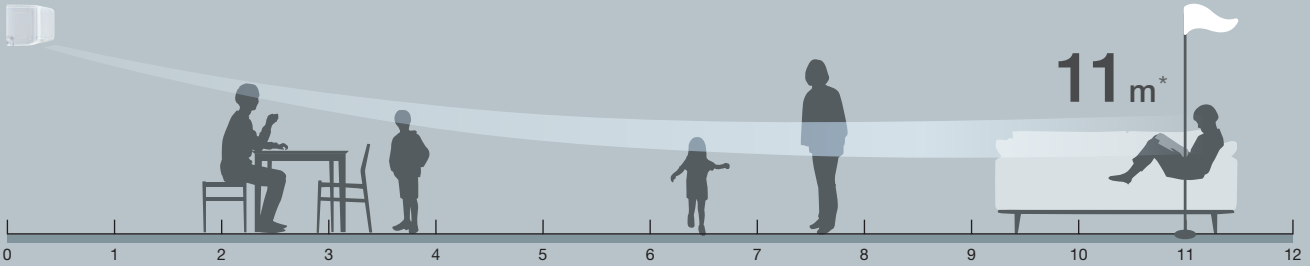
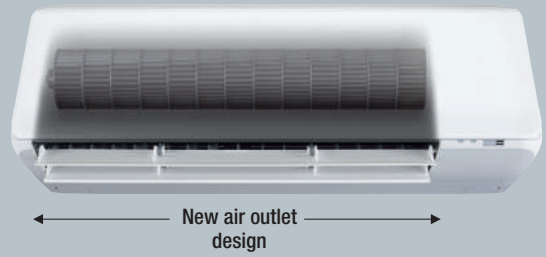

* Testing was conducted in internal laboratory using the 5 kW model. Operation In cooling mode under Hi-Power operation.
 • The actual warm-up time during real use may vary depending on conditions.



Cross Flow Fan (Anti-microbial fan)

Extra silent unit / 19 dB(A)*

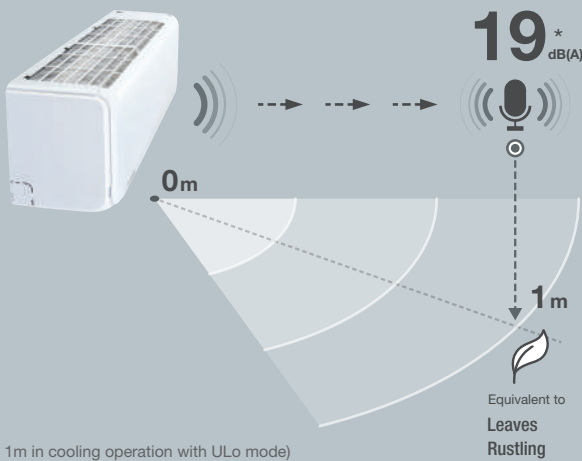

* (at 1m in cooling operation with ULo mode)

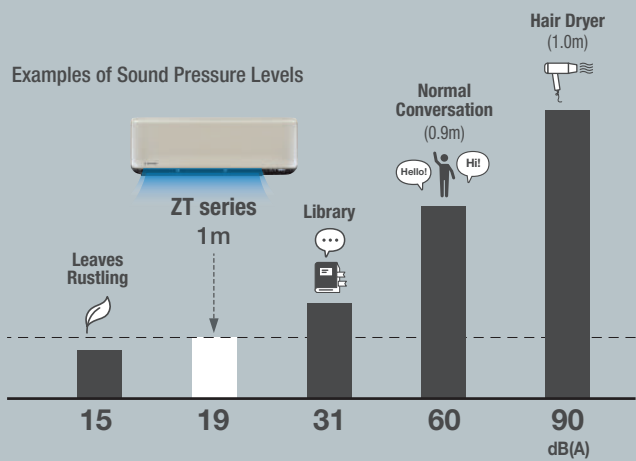

Powerful performance on cold days

The unit can operate at its nominal heating capacity even when the temperature drops to -10°C , ensuring reliable and a powerful performance, even on cold days.

Keeping nominal heating capacity at -10°C

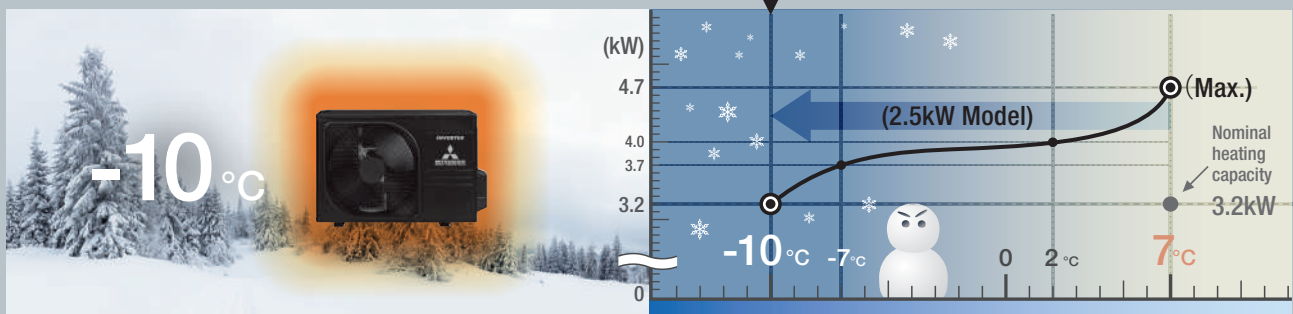

The results are based on internal tests, and actual performance may vary depending on operating conditions.

Remote Control

The usability has increased with the adoption of the new remote control.

Enhanced visibility with back-light for easy reading

Operation range of the unit has been expanded

Cooling operation range: 16°C to 33°C

Heating operation range: 10°C to 30°C

Temperature control in 0.5°C units

New remote control

Night setback operation

With a single push of a button, the Night Setback mode can be activated, maintaining the unit at a 10°C operation. This mode is ideal for unoccupied rooms during night-time, ensuring the temperature does not drop significantly while consuming less energy compared to normal operation mode. When reverting to normal heating mode, the room warms up quicker than starting from power-off, providing greater comfort on cold mornings or when returning home on a chilly day.

Ideal for cold mornings or returning home on a chilly day

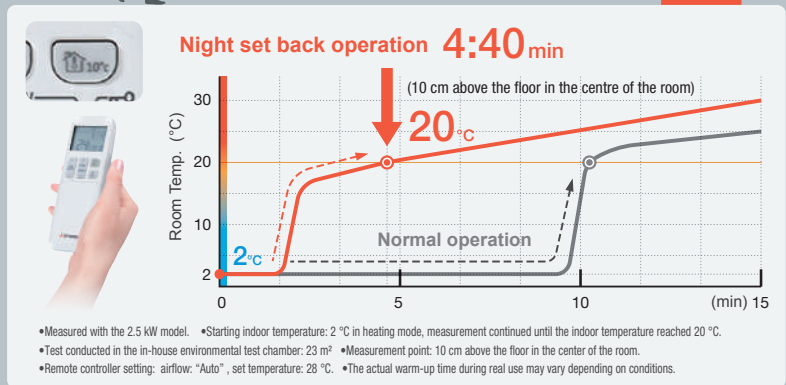

For the outdoor unit

Ultra silent mode

The unit has been equipped with an ultra silent control making the unit noise as low as 36dB(A). With a simple push of a button the compressor operation and the fan speed is adjust to maintain a quiet operation.

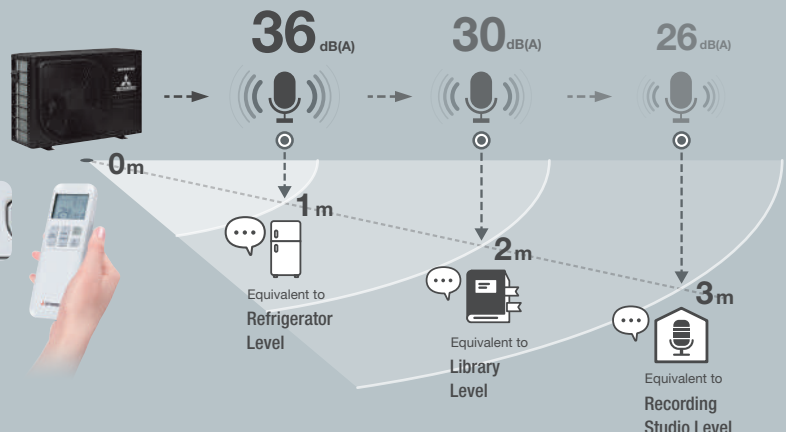

Smart Control

Be in full control of your air-conditioner at anytime, from anywhere. Simply install the Smart M-Air app on your smartphone to enjoy seamless remote operation.



Functions

- 1 ON/OFF
- 2 Operation modes
- 3 Set point
- 4 Timers
- 5 Favourite setting

Notifications

- 1 Shut-off reminder alert
- 2 Hi temp / low temp alert
- 3 Home Leave Mode
- 4 Watching function



Search for "Smart M-Air" from the GooglePlay™ store for Android™ and AppStore for iPhone.

Please check the app stores for the latest supported OS version information

For ZT Series

New easy to read charts

The new charts are simple for users to read, using simple charts to show various data. Users can request to view a single Day/Month/Year, enabling users to make adjustments as needed.

- 1 **Energy Consumption**
(Bar Graph, Stacked)
- 2 **Efficiency (COP)**
(Line Graph) categorized by Mode
- 3 **Heating / Cooling Capacity**
(Bar Graph) categorized by Mode
- 4 **Outdoor Temperature Indoor Temperature Set Temperature**
(Line Graph) categorized by Mode

CSV export of the following data is available

1. Power consumption (Unit: kWh)
2. Efficiency (COP)
3. Heating / Cooling capacity (Unit: kWh)
4. Outdoor temperature (Unit: °C or °F)
5. Operating mode (Cooling, Heating, others)
6. Set temperature, Indoor temperature (Unit: °C or °F)

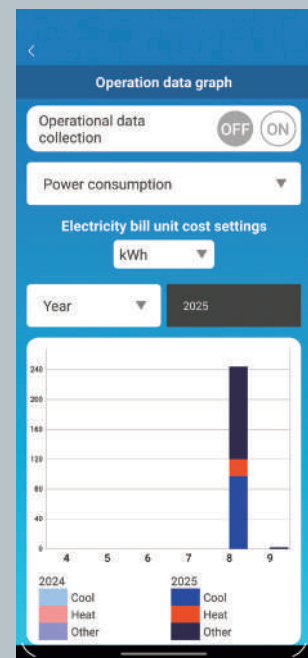

Voice Control Function

Smart Speaker



Alexa,
Turn on the
"LIVING ROOM"

Alexa,
Turn off the
"LIVING ROOM"

OK Google,
Turn down the
temperature in the
"LIVING ROOM"

Take control of your MHI air-conditioners effortlessly! Use the Smart M-Air app and any compatible smart speaker to control your ambient temperature with just your voice.

Amazon Alexa™

- 1 Air-conditioner ON/OFF
- 2 Changing operating mode (auto/cool/heat)
- 3 Change set temperature
- 4 Checking operating condition of air-conditioners
- 5 Detect (*1*2*3) air-conditioner, etc.

Google Assistant™

- 1 Air-conditioner ON/OFF
- 2 Changing operating mode (auto/cool/heat/fan/dry)
- 3 Change set temperature
- 4 Checking operating condition of air-conditioner
- 5 Synchronize (*1*2*3) air-conditioner, etc.

*1 Air-conditioners added by the Smart M-Air smartphone application can now be used on smart speaker.
*2 Support function may be expanded in the future. For the latest support, go to the Smart M-Air skill overview page in the smart speaker settings application.
*3 An example of voice command is when you set the air-conditioner name to "LIVING ROOM" in the "Smart M-Air" smartphone application or the smart speaker setting application. Replace " " with the name of the air-conditioner you set.
*4 For the voice command example for Google Assistant™ Please refer to our manuals.

The voice control function is currently available only in English for Google Assistant™.
For Amazon Alexa™, the function is available in English for the following countries.
Australia / New Zealand / United Kingdom / Ireland / Singapore / Iceland / Albania / Estonia / Cyprus / Greece / Croatia / Sweden / Slovakia / Slovenia / Czech Republic / Denmark / Norway / Hungary / Finland / Bulgaria / Poland / Bosnia and Herzegovina / Portugal / Malta / Montenegro / Latvia / Lithuania / Romania
For availability in other regions, please consult your installer.
*For some models, the wireless control system may not be applicable.

Indoor Air Quality

Allergen Clear Operation



1. Catching Allergens on the Filter

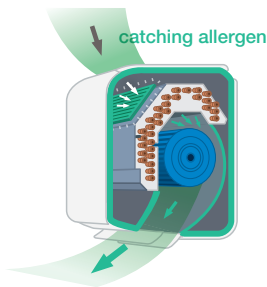

2. Cooling Operation

To make condensing water.

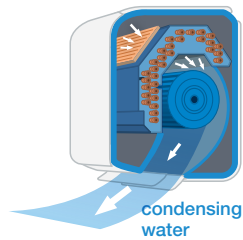

3. Heating Operation

To give moisture to the Filter to inactivate allergen

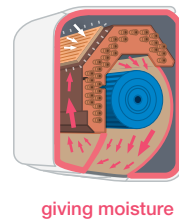

4. Air Purifying Self-Clean Operation

To dry up the indoor unit

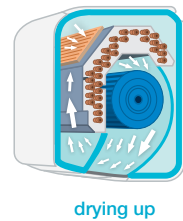

This feature can be activated by pressing the “allergen” button on the remote control, the cycle 90 minutes before stopping automatically.

It neutralises the bacteria collected on the surface of the anti-allergenic filter thanks to its sophisticated interaction between temperature and humidity controls.

Allergen Clear Filter Enzyme + Urea deactivates allergens and bacteria

The allergen clear filter breaks down pollen^{*1}, lice^{*1}, and allergens, etc. and deactivates them. The effectiveness of deactivation is due to the Enzyme-urea compound, it deactivates not only allergens but also various types of bacteria^{*2}, molds and viruses^{*3}, to ensure fresh, clean air is maintained in your internal environment.



^{*1} Test method : ELISA colorimetric method Laboratory : Independent administrative agency national hospital mechanism Sagamiara Hospital, No.1536

^{*2} Test method : ELISA colorimetric method / ELISA fluorescent method Laboratory: Independent administrative agency national hospital mechanism Sagamiara Hospital, No.1536

^{*3} Test method : TCID (Infection value 50%) Laboratory: Foundation of Kitazato Environmental Science Center, No.15-0145

Easy Maintenance / Installation

The bottom of the panel can be easily removed, ensuring pipework is easily accessible for maintenance and installation.

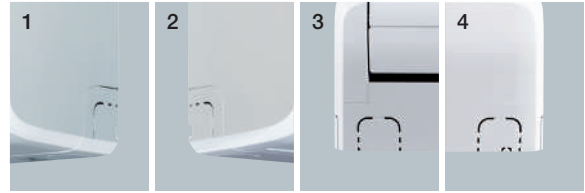
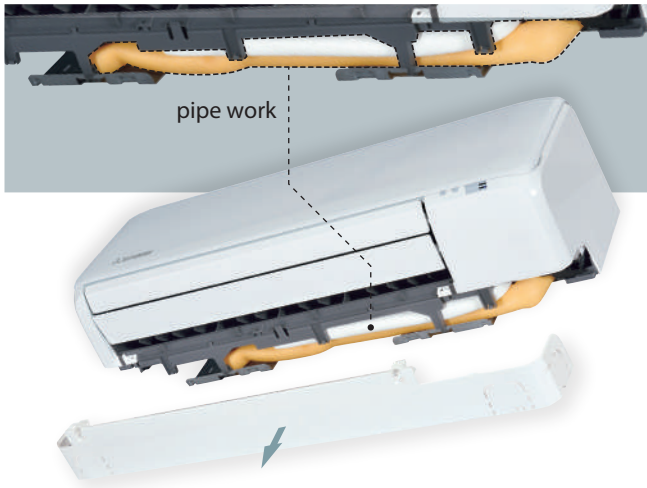

The sides and bottom of the unit feature perforated knockout sections, providing flexible options for piping and insulation placement.

During installation, the plastic panels have already been pre-cut and deburred to ensure quick installation.

Interface kit for wired remote control

For the ZT series, the Interface kit can be integrated within the unit itself.



SC-BIKN2-BL (Option)

New Casing Structure +



For applications requiring wired remote control, an interface is used. In the ZT series, with its new casing structure, this interface can be seamlessly housed within the indoor unit, providing a more aesthetically pleasing appearance.

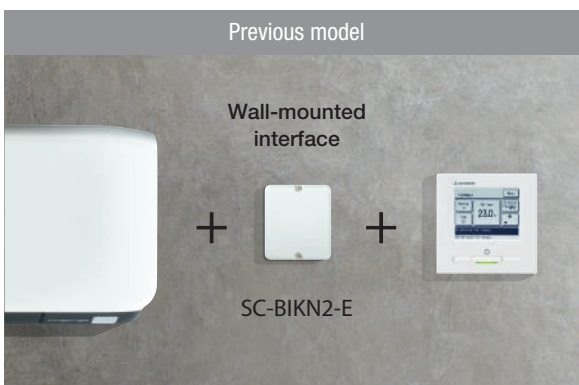
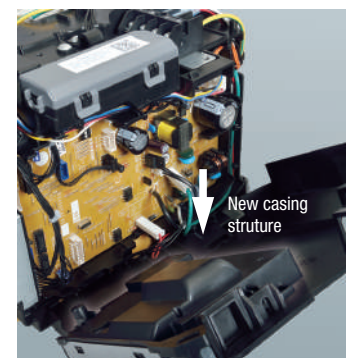
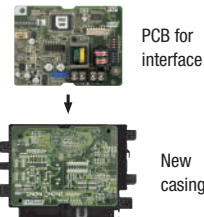
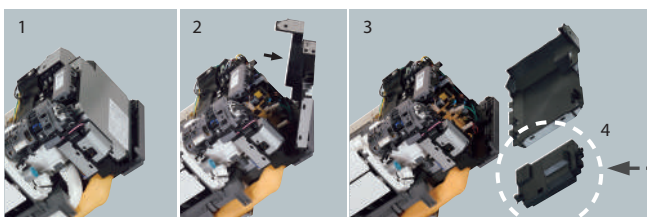

Advanced Technology in MHI Residential Air Conditioners Performance & Technology

Many design changes and engineering developments have taken place in order to improve the energy efficiencies in our products.

High Efficient Performance

Mitsubishi Heavy Industries Thermal System's product ZSX and ZT series have a seasonal SEER/SCOP performance which boosts energy ratings from classes A+ to A+++.

High Energy Performance (SEER/SCOP) and Class

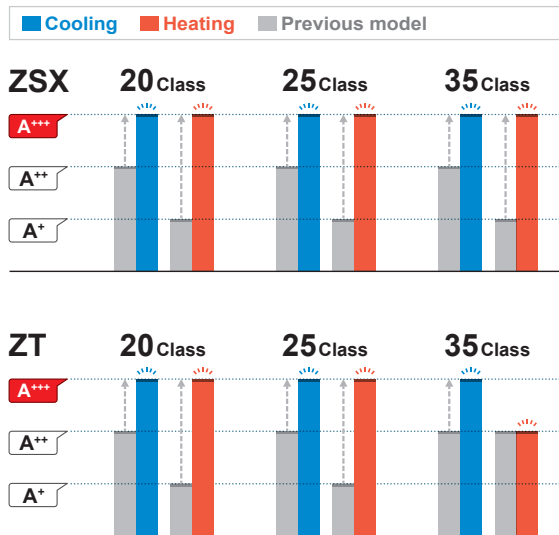

DC PAM Inverter

Experience the cutting-edge Pulse Amplitude Modulation (PAM) inverter technology. Air-conditioners equipped with this system deliver robust heating and cooling performance, swiftly achieving your desired temperature. The finely controlled compressor speed ensures both comfort and energy efficiency.

Conventional inverter

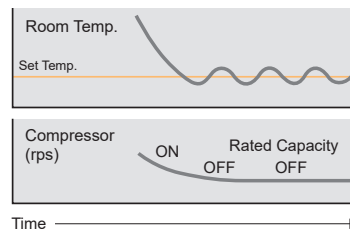

Less advanced technology does not address the ON/OFF cycles issue.

DC PAM inverter

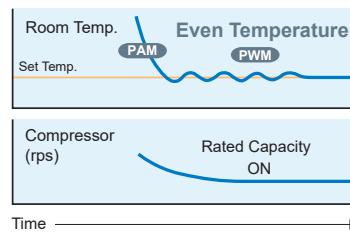

Utmost comfort and energy efficiency achieved with large output power and control optimization.

DC Twin Rotary Compressor

Introducing our well-established and dependable DC twin rotary compressor technology. Designed for optimal performance, it ensures low noise, minimal vibration, and high efficiency across an extensive range of operating conditions.



Featured on all models of ZSX series

Wide Range of Operation

SR series air-conditioners are designed to thrive in challenging environmental conditions. The ZSX series can operate efficiently in extreme temperatures, as low as -20°C in heating mode and up to 46°C in cooling mode. Whether you need to keep your smallest bedroom cozy or cool down a large entertainment area, the ZSX series has you covered.

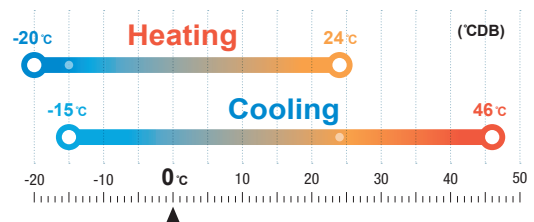

* For the capacities under low temperature conditions, refer to technical manual.

Latest Technologies (ZSX series)

[Outdoor unit]

Propeller fan

Meticulously designed with blade serrations for whisper-quiet operation without compromising performance. Experience the perfect blend of efficiency and comfort.

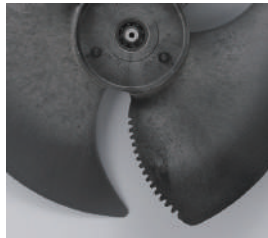

Serrated fan blade

Coated PCB (Printed Wiring Board)

The coated Printed Wiring Board is designed to withstand the elements, it ensures longevity and reliable performance thanks to improved tolerance to humidity.

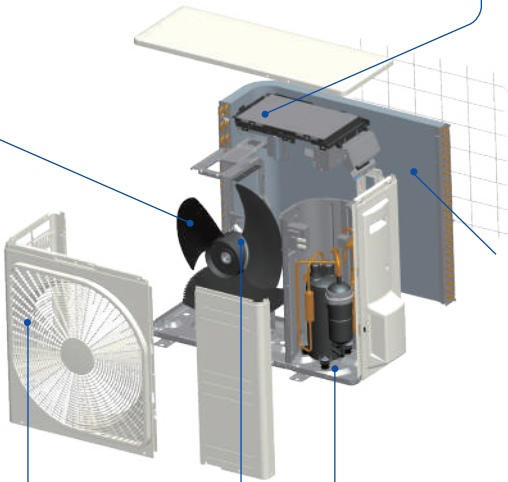
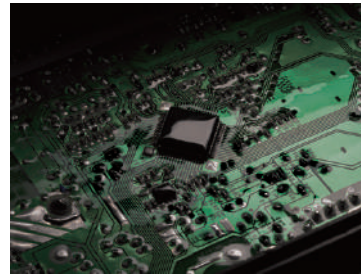

Heat exchanger

M-shape fins strike the perfect balance between heat transfer and airflow resistance, ensuring top-notch performance in diverse climate.

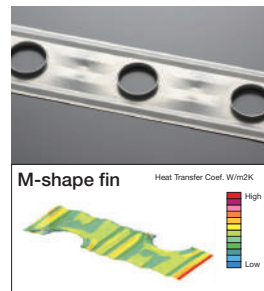

Fan grille

Innovative grille design that not only enhances airflow efficiency, but also reduces noise levels.

Corrosion resistance

The base panel made from hot-dipped sheet steel, boasts exceptional corrosion resistance and remarkable scratch resilience.



DC Fan Motor

Cutting-edge DC fan motors which deliver exceptional efficiency and impressive power. These DC motors consume less power compared to traditional AC motors.

Three Sensors

Control of room temperature and humidity is very important for people to live a comfortable life. Use of three sensors to control indoor temperature, indoor humidity and outdoor temperature enable unit to obtain optimum air-conditioning.



Sensor for indoor temperature and humidity



Sensor for outdoor temperature

[Indoor unit]

Heat exchanger

Our optimal combination of fin configuration and copper tube has maximised airflow volume without expanding indoor unit's size in width. Compared with previous models, the heat exchanger efficiency rate has drastically improved by 33%. The fin can maximise airflow volume and save energy simultaneously.

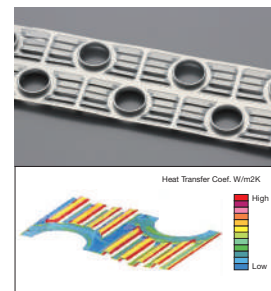

AIR FLOW



Jet Air Technology

CFD (Computational Fluid Dynamics), commonly used for precision jet engine blade design, has now transformed air-conditioning. Our cutting-edge indoor air distribution system ensures very quiet operation and unparalleled energy efficiency across diverse indoor spaces.

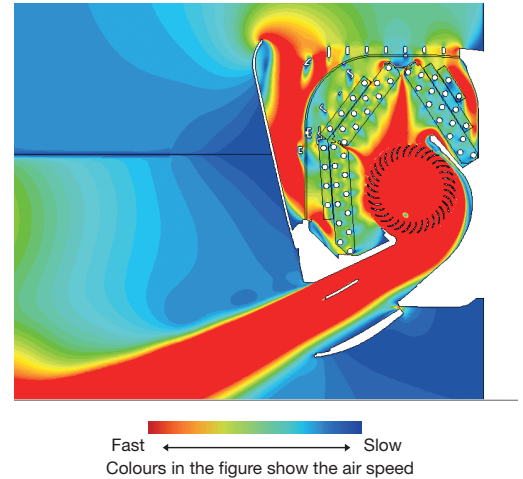
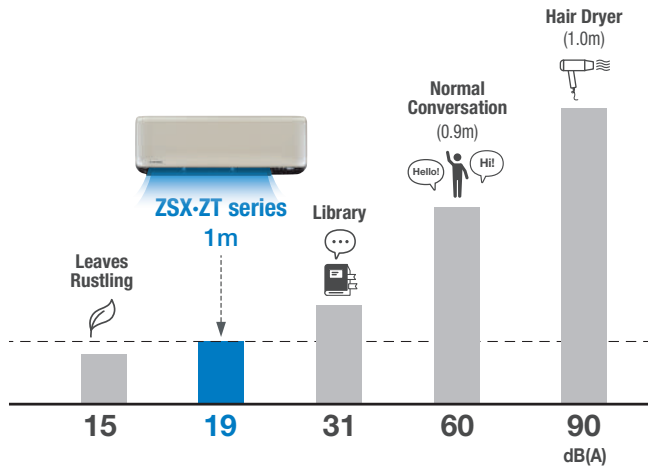

Long Reach Air Flow

Long reach air flow is achieved by jet air technology. Good for large living rooms and shops, which increases comfort.



Double Flap

Comfort temperature is achieved by using the double flap system which optimises the air flow. This is also capable of producing horizontal and long reaching air flow in cooling operation, and strong and downward air flow in heating operation.





3D AUTO

Experience effortless comfort with 3D AUTO technology. With a simple tap on the remote control, it springs into action, with an uniform air distribution. Our intelligent logic takes over, fine-tuning airflow direction and intensity for optimal comfort. In cooling mode, a refreshing breeze cascades from above, while in heating mode, cozy warmth envelops the entire floor.

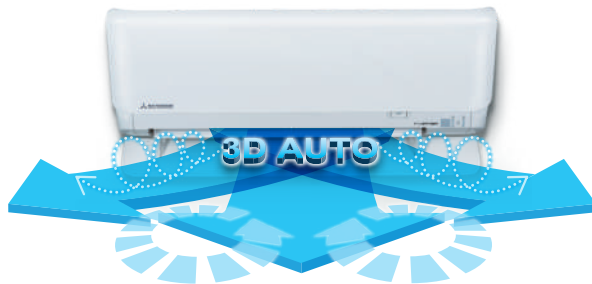

Programmed air distribution

3D Auto logic

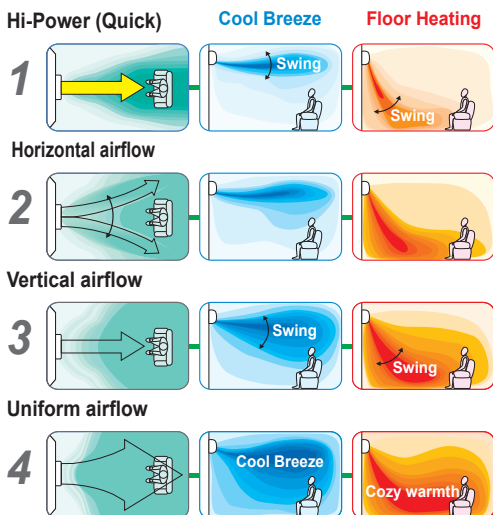

Horizontal swings in 8 directions

The airflow direction from the right and left louvers can be controlled individually. Eight different air flow patterns can be selected.

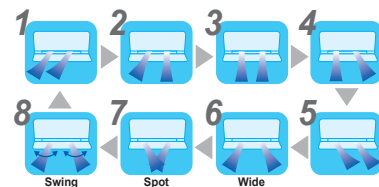

Adjustable air inlet panel

Minimisation of air resistance is achieved by incorporating a movable air inlet panel of advanced design.



* This page mainly describes the ZSX series.

AIR QUALITY



Allergen Clear Operation

This can be activated by pressing the “allergen” button on the remote control and lasts 90 minutes before stopping automatically. It neutralises the bacteria collected on the surface of the anti-allergenic filter thanks to its sophisticated interaction between temperature and humidity controls.

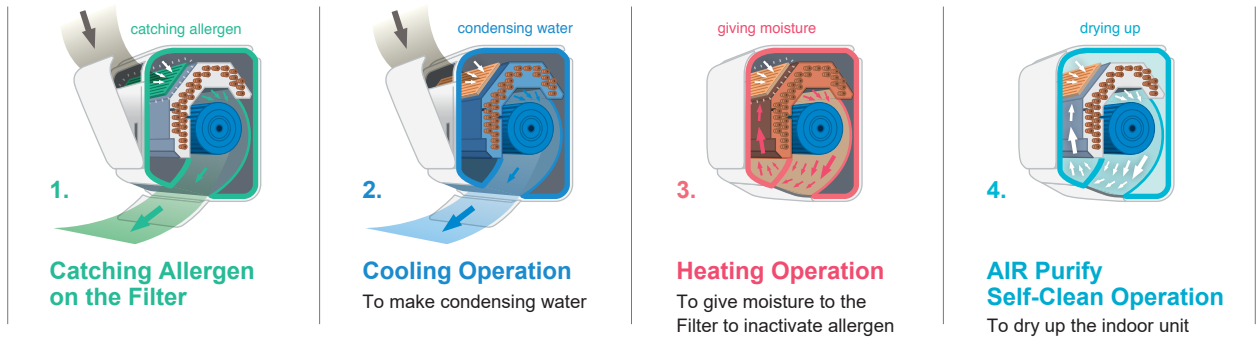

Self Clean Operation

Activate the self-clean operation and the indoor unit dries up with closed flaps, preventing mold growth.

Situation of mold after one week

Without “Self Clean Operation”



With “Self Clean Operation”

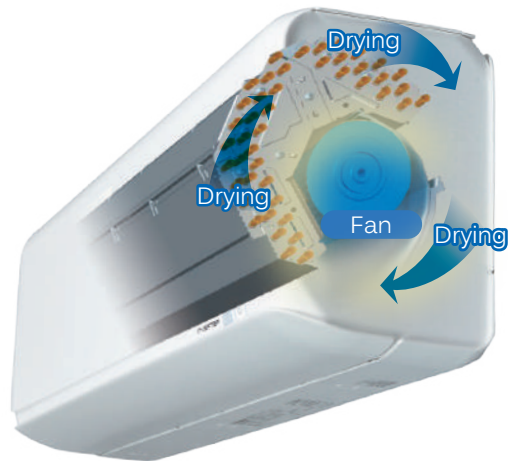
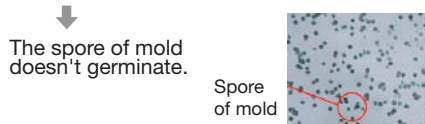

Allergen Clear Filter

Enzyme + Urea deactivates allergens and bacteria



The allergen clear filter breaks down the pollen¹, lice¹, and allergens that live on cat skins, etc. and deactivates them. The secret of deactivation is the Enzyme-urea compound. It deactivates not only allergens but also all kinds of bacteria², molds and viruses³. Even if allergens and bacteria, etc. fly of the filter, they are deactivated, so the air in your room is kept fresh.

*1 Test method:
ELISA colorimetric method Laboratory:
Independent administrative agency
national hospital mechanism Sagamihara
Hospital, No.1536

*2 Test method:
ELISA colorimetric method / ELISA
fluorescent method Laboratory:
Independent administrative agency
national hospital mechanism Sagamihara
Hospital, No.1536

*3 Test method:
TCID (Infection value 50%) Laboratory:
Foundation of Kitazato Environmental
Science Center, No.15-0145

Structure of Preventing Dirt

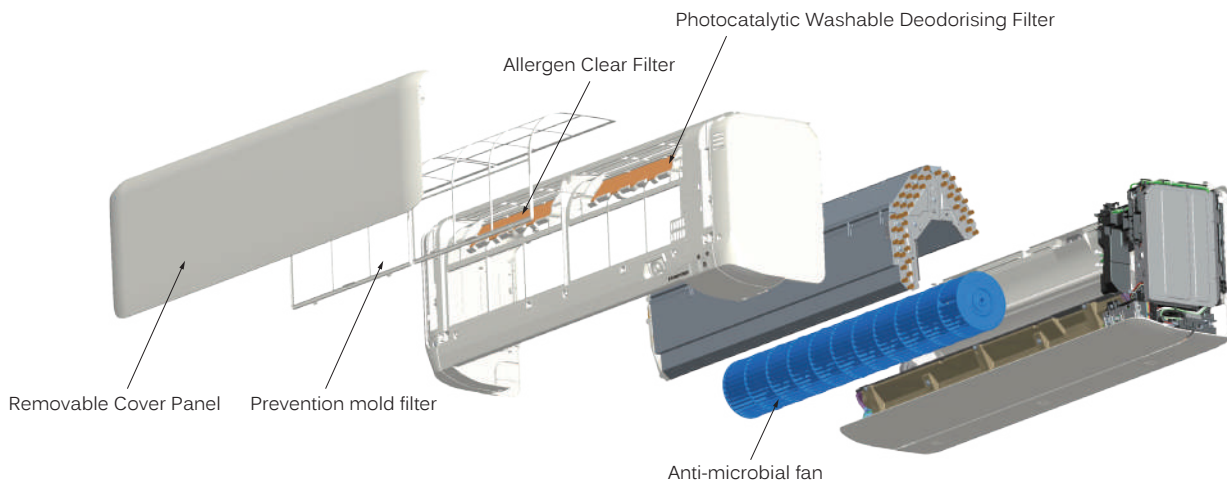

Always keeping the indoor unit clean

The fan has undergone anti-microbial treatment to resist mold and germs, making the system clean and safe. This prevents foul odours, molds, etc. which can occur when an air-conditioning system is not in operation.

(Compatible with all wall mounted type units.)

- Efficacy of "Anti-microbial"

Testing Authority: Japan Food Analysis Center
 Test Report No. : 17067139001 - 0301
 JIS Z 2801 Antimicrobial Products - Test for Antimicrobial Activity and Efficacy
 Test Report No. : 17067139001 - 0501
 JIS Z 2911 Methods of Test for Fungus Resistance
 Tests were conducted with reference to the antimicrobial strength tests as follows Delere.

without Anti-microbial

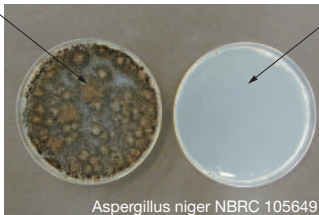

with Anti-microbial



Aspergillus niger NBRC 105649

Comparison of growth of bacteria and mold on fan surfaces (microscopic image)

Tests conducted at the Mitsubishi Heavy Industries Nagoya Research Lab, 24 hours after contact with bacteria, cultured on agar media.

Photocatalytic Washable Deodorising Filter

The deodorising power can be restored by washing with water and drying in the sun, as such it is a recyclable deodorising filter capable of repeat use.

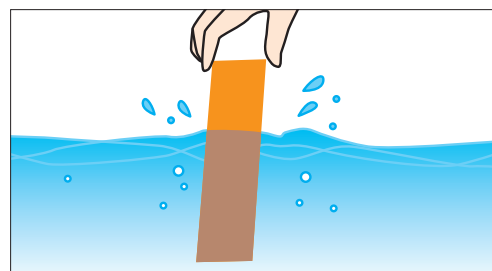
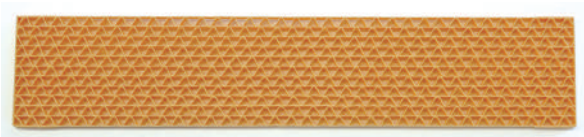

Used in models

Filter	Indoor Unit	SRK-ZSX	SRK-ZR	SRK-ZT	SRK-ZTL
Allergen Clear Filter		1pc	1pc	1pc	1pc
Photocatalytic Washable Deodorising Filter		1pc	1pc	1pc	-

* This page mainly describes the ZSX series.

ENERGY SAVING / COMFORT



Eco Operation

This control is a smart energy-saving feature that detects human activity using a motion sensor. The air-conditioner adjusts cooling/heating setpoint up to +/- 3°C based on human activity. It saves energy during low activity, while it optimizes operation when detecting high activity. Plus, when the room is empty, it automatically reduces capacity after 15 minutes, returning to normal when people return.

Cooling



It is set to moderate operation when there is little movement in the room.

Heating



It is set to moderate operation when there is a volume of movement in the room.

Stand-by mode

Our air-conditioners automatically enters 'stand-by' mode after 1 hour of inactivity. It reactivates when human activity is detected within 12 hours, or turns off completely after 12 hours of absence.

*Can also be set to turn OFF after two hours.

Absent



Moderate operation

It suppresses the power when there is nobody present in the room.

After 1-hour



Stand-by

You do not need to worry, even if you forget to turn off the power. Air-conditioner stops until human activity is detected.

Come back to room



Normal operation turns ON again

Automatically operates in the preset mode if you return to the room within twelve hours.

Fuzzy Auto Mode

Experience optimal comfort with our smart climate control system. Our temperature and humidity sensors continuously monitor room conditions, while the unit automatically adjusts the operation mode and temperature settings for maximum efficiency. With fuzzy auto mode, you'll stay comfortable even as weather conditions fluctuate.



High Power Operation

Cooling & heating operation

Experience instant relief with our High Power Operation mode. Whether you're returning home on a scorching summer day or on a chilly winter day, our air-conditioner provides a refreshing burst of coolness or cozy warmth, ensuring you feel great right away. Plus, it is smart enough to revert to your preferred mode after 15 minutes, ensuring optimal comfort without excessive cooling or heating.

Silent Operation

Silent mode ensures a peaceful environment. Whether you're working, relaxing, or sleeping, our air-conditioner operates at 3dB(A) lower than standard nominal level (45dB(A) or less).



Night Setback

During cold seasons or chilly weather, the night setback operation allows to maintain room temperatures at a cozy 10°C, even when the room is unoccupied or when you're away from home.



Fireplace Function

By continuing to operate the indoor fan when the room temperature is stabilized, the warm air accumulated in the ceiling is circulated to the room.

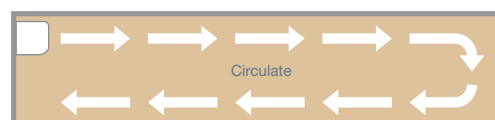

* This page mainly describes the ZSX series.

TIMER / CONVENIENCE

Weekly Timer

Set specific times for your air-conditioner to turn on and off automatically. Wake up to a cozy home in winter or return to refreshing coolness after a long day. By programming your air-conditioner's schedule, you'll reduce energy consumption.

Up to 4 timer programs can be created for each day of the week, allowing a maximum of 28 programs per week.

Sleep Timer

This function ensures optimal comfort during rest by adjusting cooling or heating capacity. It also allows to save energy without excessive temperature change.

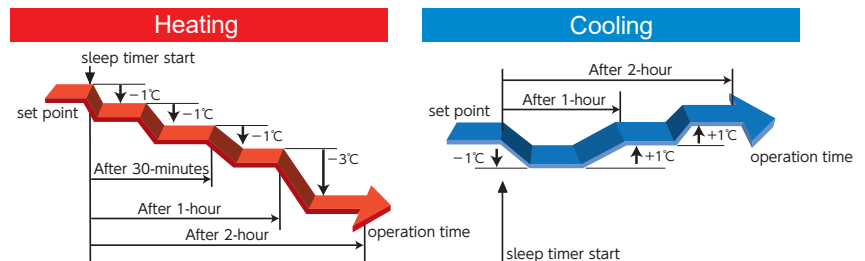

Comfort start-up

Its time to experience perfectly timed cooling and warmth. Air conditioner controls room temperature to achieve comfort at the "set time" by 60-minutes pre-operation.

In ON-TIMER operation, the unit starts the operation a little earlier, so that the room can approach optimum temperature at ON time.

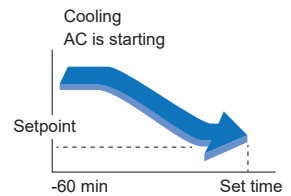

Preset Operation

With our advanced technology, you can save your preferred settings for future use. Whether it's the operation mode, temperature, fan speed, or airflow direction, we've got you covered. No more adjusting settings every time you turn on the air-conditioner.

Simply activate your personalized presets, and let the magic happen.

LED Brightness Adjustment

Our air-conditioner's LED display adapts to your preference. Whether you prefer a bright, subtle glow or no indicator, you're in control. Simply set it to match your mood and enjoy a personalized experience. (ZSX,ZT,ZTL)



Long Piping Length

With ZSX series, you are not limited by distance. Enjoy up to 30 meters of piping length, giving you the freedom to design your AC system exactly as you envision. Our compact outdoor unit fits seamlessly into small installation spaces. It can discreetly blend in while delivering powerful performance.

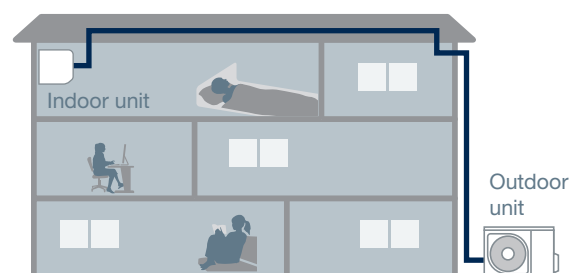

CONVENIENCE



Wireless Control System

Control your air-conditioner from anywhere, anytime

Turn it on while you're out, and arrive home to perfect comfort. Forgot to switch it off? No worries! Just tap your phone, and it's done. Whether you're at work, shopping, or exploring, your air-conditioner awaits your command.

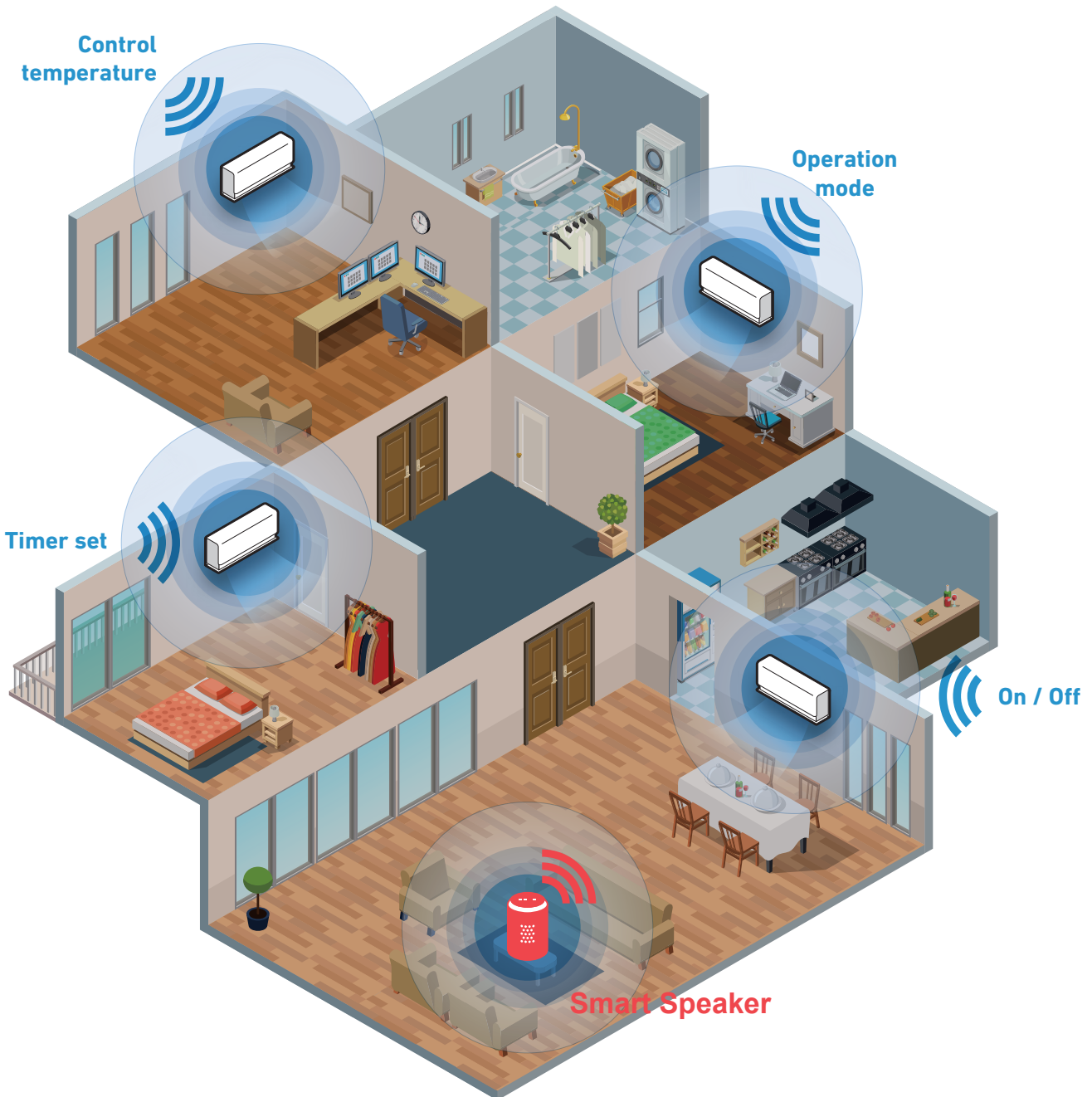

WIRELESS CONTROL SYSTEM

Take control of your air-conditioner anytime, anywhere with the Smart M-Air app. Simply install it on your smartphone or tablet, and enjoy seamless remote operation.



Search for "Smart M-Air" from the Google Play™ store for Android™ and App Store for iPhone.



Please check the app stores for the latest supported OS version information



Functions

- 1 ON/OFF
- 2 Operation modes
- 3 Set point
- 4 Timers
- 5 Favourite setting

Notifications

- 1 Shut-off reminder alert
- 2 Hi temp / low temp alert
- 3 Home Leave Mode
- 4 Watching function

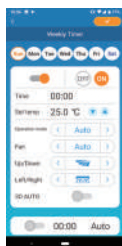

Weekly Timer

This function allows you to set up to six different configurations per day, including operation mode, temperature, airflow direction, and speed.



Home Leave Mode

When the room temperature falls below or rises above the Home Leave set temperature, the system kicks in to maintain a comfortable indoor environment.



Vacant Property Mode

When a property is vacant for a period of time, the temperature settings can be adjusted to maintain a pleasant atmosphere:
 - Cooling 31°C to 33°C
 - Heating 10°C to 17°C"



Electricity Bill Graph

Keep an eye on your energy usage and visualize your monthly electricity bill with our intuitive graphs. Stay in control and make informed decision.

Wireless LAN Built-in model



Applicable products

Built-in

- 1 SRK-ZSX -WF/-WFB/-WFT
- 2 SRK-ZR -WF
- 3 SRK-ZS -WF/-WFB/-WFT
- 4 SRK-ZT -WF/-WFB/-WFT
- 5 SRK-ZTL -W

Optional

- 1 SRK-ZSX -W/-WB/-WT/-S
- 2 SRK-ZR -W/-S
- 3 SRK-ZS -W/-WB/-WT
- 4 SRK-ZS -S/-SB/-ST

Model :WF-RAC



* For the units that does not include wireless LAN the function could be used by adopting an option (WF-RAC)

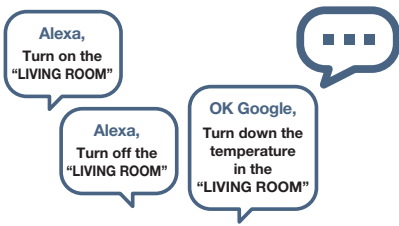

Voice control function

Take charge of your MHI air-conditioners effortlessly! Use the Smart M-Air app and any compatible smart speaker to control your ambient temperature with just your voice.

Amazon Alexa™

Functions

- 1 Air-conditioner ON/OFF
- 2 Changing operating mode (auto/cool/heat)
- 3 Change set temperature
- 4 Checking operating condition of air-conditioners
- 5 Detect (*1*2*3) air-conditioner, etc.

Google Assistant™

Functions

- 1 Air-conditioner ON/OFF
- 2 Changing operating mode (auto/cool/heat/fan/dry)
- 3 Change set temperature
- 4 Checking operating condition of air-conditioner
- 5 Synchronize (*1*2*3) air-conditioner, etc.



Smart Speaker

Voice command example for Amazon Alexa™ *4

Air-conditioner operation	Voice command example
Start operation (Stop)	Alexa, turn on the "LIVING ROOM" (turn off)
Turn on cooling (Turn on heating)	Alexa, set the "LIVING ROOM" to cool (to heat)
Increase the temperature by 1 degree Celsius (Lower)	Alexa, increase the temperature in the "LIVING ROOM" (lower)
Increase the temperature by 2 degrees Celsius (Lower)	Alexa, increase the temperature in the "LIVING ROOM" by 2 degrees (lower)
Set temperature to 24 degrees Celsius	Alexa, set the "LIVING ROOM" temperature to 24 degrees
Respond with the operating mode	Alexa, tell me the operating mode of the "LIVING ROOM"

Air-conditioner operation	Voice command example
Respond with the set temperature	Alexa, what degrees is the "LIVING ROOM" set to
Respond with the room temperature	Alexa, what is the "LIVING ROOM" temperature
Detect added air-conditioners	Alexa, detect device

*1 Air-conditioners added by the Smart M-Air smartphone application can now be used on smart speaker.
 *2 Support function may be expanded in the future. For the latest support, go to the Smart M-Air skill overview page in the smart speaker settings application.
 *3 An example of voice command is when you set the air-conditioner name to "LIVING ROOM" in the "Smart M-Air" smartphone application or the smart speaker setting application. Replace " " with the name of the air-conditioner you set.
 *4 For the voice command example for Google Assistant™ Please refer to our manuals.

- The voice control function is currently available only in English for Google Assistant™. For Amazon Alexa™, the function is available in English for the following countries. Australia/New Zealand/United Kingdom/Ireland/Singapore/Iceland/Albania/Estonia/Cyprus/Greece/Croatia/Sweden/Slovakia/Slovenia/Czech Republic/Denmark/Norway/Hungary/Finland/Bulgaria/Poland/Bosnia and Herzegovina/Portugal/Malta/Montenegro/Latvia/Lithuania/Romania For availability in other regions, please consult your installer.
- For some models, the wireless control system may not be applicable.

System configuration

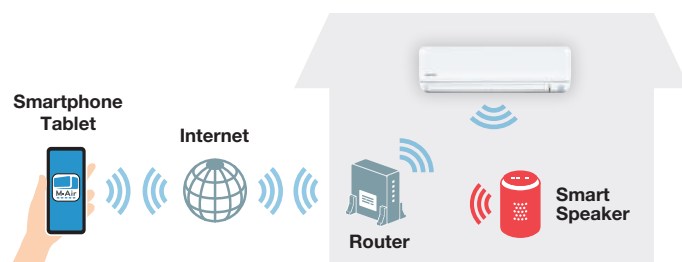

*SC-BIKN2-E cannot be used simultaneously for system configuration.

NOTE
 App Store and iPhone are registered trademark of Apple Inc.
 Google Play and the Google Play logo are trademarks of Google LLC.

Amazon, Echo, and Alexa are trademarks of Amazon.com, Inc or its affiliates.

Google, Google Home, Android, Google Play, Google Assistant, and Google Nest are trademarks of Google LLC.

Other company and product names mentioned are trademarks or registered trademarks of their respective companies.

FUNCTIONS

Energy saving



Fuzzy Auto Mode

Using fuzzy logic algorithms, the unit determines the operating mode and temperature settings automatically and adjusts the inverter frequency.



Motion Sensor

This sensor detects human activity and shifts the temperature setting according to the amount of activity in the room.



Eco Operation

Room temperature and humidity are monitored to automatically control the operation. When paired with the motion sensor, the system enables an energy saving mode while maintaining comfort.



Auto Off

Stops the operation automatically when there is no activity detected in the room for a certain period.



Economy Mode

The unit will operate in energy saving mode in order to avoid excessive heating and cooling.

Air flow



Jet Air Technology

Air flow is regulated using the same blade technology as that in jet engines which produces a powerful yet efficient air flow.



3D Auto

This one touch program will activate the three independent motors to evenly distribute air flow and create optimum heating and cooling conditions.



Auto Flap Mode

Depending on the operating mode, the unit will automatically set the position of the flaps at the optimal angle.



Memory Louver

On the next start-up the louver returns to the same position that it was when the operation last stopped.



Vertical Auto Swing

Louvers swing up and down continuously and can be set at a fixed angle.



Horizontal Auto Swing

Louvers swing right and left continuously and can be set at a fixed angle.



Draft Prevention Setting

Provides a comfortable air flow without any draft feeling. Whether cooling or heating a room, the remote control can be used to instantly suppress any warm or cool drafts.

Clean Operation & Filter



Allergen Clear Operation

Suppress the influence of the allergens caught by the Allergen Clear Filter by controlling the temperature and humidity. Enzymes are used to suppress the influence of the allergens caught during everyday operation.



Self-Clean Operation

Self clean mode dries the indoor unit and filter, preventing the growth of mould. This runs for 2 hours after the unit has been switched off.



Allergen Clear Filter

The filter breaks down the pollen, lice, and all allergens that live on cat skins, etc. and deactivates them.



Photocatalytic Washable Deodorising Filter

This easy to clean filter that catches airborne allergens and particles before neutralising odour causing bacteria within them.



Removable Cover Panel

With an easy to remove front panel, cleaning and maintenance of the indoor unit is quicker and easier than ever.

Comfort



Dry Operation

During dry operation the unit will act as a dehumidifier to remove moisture from the air.



High Power Operation

Use the high power function to quickly reach your optimum temperature level when you first turn on the unit. This function will operate for a maximum of 15 minutes before returning to normal operation.



Silent Operation

This function allows you to program periods where the unit will operate with reduced noise levels and is ideal for temperature control during the night.



Night Setback

Designed for cold season, this ensures the room temperature is kept at around 10°C, even while unoccupied.



Fireplace Function

By continuing to operate the indoor fan when the room temperature is stabilized, the warm air accumulated in the ceiling is circulated to the room.

Timer



Weekly Timer

Set your unit to turn on and off automatically on a weekly basis to suit your usual room usage on each day.



24-hour On/Off Programmable Timer

By combining the ON and OFF timers, the system starts and stops at the specified times a day.



Sleep Timer

The room temperature is automatically controlled during the set sleep mode period, ensuring that room temperature will not get too cold or too hot.



On/Off Timer

This timer allows the unit to be set to turn ON or OFF automatically once within a 24 hour period.

Convenience



Comfort Start-up

With the ON-TIMER function, the unit will switch on earlier than the SET time, to ensure the optimum temperature is reached at the ON TIME.



Preset Operation

The desired preset operation mode can be enabled with a single touch of a button.



Child Lock

Lock the remote control to prevent child from tampering with the remote control.



LED Brightness Adjustment

The unit has an adjustable LED brightness display for minimal disturbance during night operation.



Positioning of Installation

This allows you to manually set the air flow direction when the unit is installed against a wall.



Wireless Control System

You can control the air-conditioner at home or on the go by installing Smart M-Air app on your smartphone or tablet.

Others



Microcomputer-Operated Defrosting

This mode is automatically activated during low ambient temperatures to prevent the frosting of the outdoor heat exchanger and maintains heating efficiency.



Self Diagnostics

The internal microcomputer automatically runs a diagnostic of the system in the event of a malfunction. This enables your authorised dealer to isolate and repair any issues.



Auto Restart Function

If there is a temporary loss of power, when power is restored, the unit will automatically restart in the same operating mode it was in.



Back-up Switch

If the remote control fails, the unit can be operated via an on/off switch on the indoor unit.

		ZSX	ZR	ZT	ZS-S	ZTL	ZSP	SRF	SRR	FDTC ^{*3}	SKIM	FDUM ^{*3}	FDE ^{*3}
Energy saving	Fuzzy Auto Mode	●	●	●	●	●	●	●	●	●	●	●	●
	Motion Sensor	●							● ^{*4} option		● option	● option	
	Eco Operation	●							● ^{*4} option		● option	● option	
	Auto Off	●							● ^{*4} option		● option	● option	
	Economy Mode		●	●	●	●	●	●	●		●		
Air flow	Jet Air Technology	●	●	●	●	●				●			
	3D Auto	●	●	●	●	●							
	Auto Flap Mode	●	●	●	●	●	●		●	●		●	
	Memory Louver	●	●	●	●	●	●		●	●		●	
	Vertical Auto Swing	●	●	●	●	●	●		●	●		●	
	Horizontal Auto Swing	●	●	●	●	●							
	Draft Prevention Setting								● ^{*4} option				
Clean operation & Filter	Allergen Clear Operation ^{*1}	●	●	●	●	●							
	Self Clean Operation	●	●	●	●	●	●	●		●			
	Allergen Clear Filter	●	●	●	●	●		●					
	Photocatalytic Washable Deodorising Filter	●	●	●	●			●					
	Removable Cover Panel	●	●	●	●	●	●						
Comfort	Dry Operation	●	●	●	●	●	●	●	●	●	●	●	●
	High Power Operation	●	●	●	●	●	●	●	●	●	●	●	●
	Silent Operation ^{*2}	●	●	●	●	●		●	●				
	Night Setback	●	●	●	●	●		●	●				
	Fireplace Function	●		●	●	●							
Timer	Weekly Timer	●	●	● ^{*5}	●	● ^{*5}		●	●	●		●	●
	24-hour On/Off Programmable Timer			●		●	●				●		
	Sleep Timer	●	●	●	●	●	●	●	●	●	●	●	●
	On/Off Timer	●	●	●	●	●	●	●	●	●	●	●	●
Convenience	Comfort Start-up	●	●	●	●	●	●	●	●	●	●	●	●
	Preset Operation	●		●	●	●		●	●				
	Child Lock	●	●	●	●	●		●	●				
	LED Brightness Adjustment	●		●	●	●							
	Positioning of Installation	●	●	●	●	●							
	Wireless Control System	● ^{*6}	● ^{*6}	●	● ^{*6}	●							
Others	Microcomputer-Operated Defrosting	●	●	●	●	●	●	●	●	●	●	●	●
	Self-Diagnostic Function	●	●	●	●	●	●	●	●	●	●	●	●
	Auto Restart Function	●	●	●	●	●	●	●	●	●	●	●	●
	Back-up Switch	●	●	●	●	●	●	●	●		●		

*1 In case of Multi-split system, is not available. *2 It can not be used for SCM40 • 45ZS-S, SCM100 • 125ZM-S. *3 When using wired remote control (RC-EX3D). *4 FDTC-VH only *5 For the ZT and ZTL series, the "Weekly Timer" function could only be used from the application Smart M-Air. *6 -W, -S type would need an option to use the wireless function.



SINGLE-SPLIT WALL MOUNTED TYPE



SRK-ZSX-WF



SRK20,25,35,50,60ZSX-WF

Pure White(-WF)



BUILT IN WIRELESS LAN



Black & White(-WFB)



Titanium(-WFT)



Wireless remote control



SRC20,25,35ZSX-W, SRC50ZSX-W2, -W3, SRC60ZSX-W1, -W3

KEY FEATURES

The ZSX series, featuring an "Elegant Timeless Design," is ideal for small to medium-sized living spaces.

Key features include:

- High seasonal efficiency performance rated up to A+++ in cooling and heating
- Environmentally friendly with low Global Warming Potential (GWP) and high energy efficiency with refrigerant R32
- Quiet airflow and extended reach achieved through jet technology
- Available in three different colour choices for user preference
- Wireless interface control included for convenient operation

*SC-BIKN2-E cannot be used simultaneously with the Wireless LAN control system

SPECIFICATIONS

Indoor unit			SRK20ZSX-WF,-WFB,-WFT	SRK25ZSX-WF,-WFB,-WFT	SRK35ZSX-WF,-WFB,-WFT	SRK50ZSX-WF,-WFB,-WFT	SRK60ZSX-WF,-WFB,-WFT	
Outdoor unit			SRC20ZSX-W	SRC25ZSX-W	SRC35ZSX-W	SRC50ZSX-W2,-W3	SRC60ZSX-W1,-W3	
Power source			1Phase, 220 - 240V, 50Hz					
Nominal cooling capacity (Min-Max)		kW	2.0 (0.9 - 3.4)	2.5 (0.9 - 3.8)	3.5 (0.9 - 4.5)	5.0 (1.0 - 6.2)	6.1 (1.0 - 6.9)	
Nominal heating capacity (Min-Max)		kW	2.7 (0.8 - 5.5)	3.2 (0.8 - 6.0)	4.3 (0.8 - 6.8)	6.0 (0.8 - 8.2)	6.8 (0.8 - 8.8)	
Power consumption	Cooling/Heating	kW	0.31 / 0.47	0.44 / 0.59	0.74 / 0.90	1.24 / 1.36	1.71 / 1.65	
	EER/COP	Cooling/Heating	6.45 / 5.74	5.68 / 5.42	4.73 / 4.78	4.03 / 4.41	3.57 / 4.12	
Max. running current		A	9	9	9	15	15	
Sound power level	Indoor	Cooling/Heating	53 / 55	55 / 56	58 / 58	59 / 62	62 / 63	
	Outdoor	Cooling/Heating	56 / 58	57 / 58	61 / 62	63 / 61	65 / 64	
Sound pressure level	Indoor	Cooling (Hi/Me/Lo/Ulo)	38 / 31 / 24 / 19	39 / 33 / 25 / 19	43 / 35 / 26 / 19	44 / 39 / 31 / 22	48 / 41 / 33 / 22	
		Heating (Hi/Me/Lo/Ulo)	38 / 33 / 25 / 19	40 / 34 / 27 / 19	42 / 35 / 28 / 19	47 / 41 / 33 / 23	47 / 42 / 34 / 23	
	Outdoor	Cooling/Heating	43 / 45	44 / 45	48 / 47	51 / 49	52 / 53	
		Air flow	Indoor	Cooling (Hi/Me/Lo/Ulo)	11.3 / 9.1 / 6.0 / 5.0	12.2 / 10.0 / 6.7 / 5.0	13.1 / 10.8 / 7.3 / 5.0	14.3 / 12.4 / 7.8 / 5.4
Exterior dimensions	Indoor	Height x Width x Depth	305 x 920 x 220					
	Outdoor	Height x Width x Depth	640 x 800(+71) x 290					
Net weight		Indoor / Outdoor	13.0 / 43.0				13.0 / 45.0	
Refrigerant	Type/GWP		R32 / 675					
	Charge	kg/TCO-Eq	1.20 / 0.810					
Refrigerant piping size		Liquid/Gas	6.35(1/4") / 9.52(3/8")					
Refrigerant line (one way) length [chargeless length]		m	Max.25 [15]					
Vertical height differences		Outdoor is higher/lower	Max.15 / Max.15					
Outdoor operating temperature range	Cooling	°CDB	-15 to 46					
	Heating	°CDB	-20 to 24					
Clean filter			Allergen Clear Filter x1, Photocatalytic Washable Deodorising Filter x1					

• The data are measured under the following conditions(ISO-T1, H1). Cooling: Indoor temp. of 27°CDB, 19°CWB, and outdoor temp. of 35°CDB.

• Heating: Indoor temp. of 20°CDB, and outdoor temp. of 7°CDB, 6°CWB.

• Sound level indicates the value in an anechoic chamber. During operation these values are somewhat higher due to ambient conditions.

• 'tonne(s) of CO₂ equivalent' means a quantity of greenhouse gases- expressed as the product of the weight of the greenhouse gases in metric tonnes and of their global warming potential.



SINGLE-SPLIT WALL MOUNTED TYPE

Diamond Series

SRK-ZSX-W



SRK20,25,35,50,60ZSX-W



OPTIONAL



Wireless remote control



SRC20,25,35ZSX-W
SRC50ZSX-W2,-W3
SRC60ZSX-W1,-W3

KEY FEATURES

- High seasonal efficiency performance rated up to A+++ in cooling and heating
- Environmentally friendly with low Global Warming Potential (GWP) and high energy efficiency thanks to the R32 refrigerant
- Jet technology ensures quiet airflow and extended reach
- Allergen clear operation cleans the air using Mitsubishi Heavy Industries Thermal Systems' proprietary control scheme
- Optional wireless interface control for added convenience

SPECIFICATIONS

Indoor unit			SRK20ZSX-W	SRK25ZSX-W	SRK35ZSX-W	SRK50ZSX-W	SRK60ZSX-W
Outdoor unit			SRC20ZSX-W	SRC25ZSX-W	SRC35ZSX-W	SRC50ZSX-W2,-W3	SRC60ZSX-W1,-W3
Power source			1Phase, 220 - 240V, 50Hz				
Nominal cooling capacity (Min-Max)		kW	2.0 (0.9 - 3.4)	2.5 (0.9 - 3.8)	3.5 (0.9 - 4.5)	5.0 (1.0 - 6.2)	6.1 (1.0 - 6.9)
Nominal heating capacity (Min-Max)		kW	2.7 (0.8 - 5.5)	3.2 (0.8 - 6.0)	4.3 (0.8 - 6.8)	6.0 (0.8 - 8.2)	6.8 (0.8 - 8.8)
Power consumption		Cooling/Heating	kW		kW		kW
EER/COP		Cooling/Heating	6.45 / 5.74	5.68 / 5.42	4.73 / 4.78	4.03 / 4.41	3.57 / 4.12
Max. running current		A	9	9	9	15	15
Sound power level	Indoor	Cooling/Heating	dB(A)		dB(A)		dB(A)
	Outdoor	Cooling/Heating	53 / 55	55 / 56	58 / 58	59 / 62	62 / 63
Sound pressure level	Indoor	Cooling/Heating	dB(A)		dB(A)		dB(A)
		Cooling (Hi/Me/Lo/Ulo)	56 / 58	57 / 58	61 / 62	63 / 61	65 / 64
	Outdoor	Cooling (Hi/Me/Lo/Ulo)	38 / 31 / 24 / 19	39 / 33 / 25 / 19	43 / 35 / 26 / 19	44 / 39 / 31 / 22	48 / 41 / 33 / 22
		Heating (Hi/Me/Lo/Ulo)	38 / 33 / 25 / 19	40 / 34 / 27 / 19	42 / 35 / 28 / 19	47 / 41 / 33 / 23	47 / 42 / 34 / 23
Air flow	Indoor	Cooling/Heating	m ³ /min		m ³ /min		m ³ /min
		Cooling (Hi/Me/Lo/Ulo)	43 / 45	44 / 45	48 / 47	51 / 49	52 / 53
	Outdoor	Cooling/Heating	11.3 / 9.1 / 6.0 / 5.0	12.2 / 10.0 / 6.7 / 5.0	13.1 / 10.8 / 7.3 / 5.0	14.3 / 12.4 / 7.8 / 5.4	16.3 / 13.4 / 8.9 / 5.4
Exterior dimensions	Indoor	Height x Width x Depth	mm		mm		mm
	Outdoor	Height x Width x Depth	mm		mm		mm
Net weight		Indoor / Outdoor	kg		kg		kg
Refrigerant		Type/GWP			R32 / 675		
		Charge	kg/TCO:Eq		kg/TCO:Eq		kg/TCO:Eq
Refrigerant piping size		Liquid/Gas	ø mm		ø mm		ø mm
Refrigerant line (one way) length [chargeless length]		m	m		m		m
Vertical height differences		Outdoor is higher/lower	m		m		m
Outdoor operating temperature range		Cooling	°CDB		°CDB		°CDB
		Heating	°CDB		°CDB		°CDB
Clean filter			Allergen Clear Filter x1, Photocatalytic Washable Deodorising Filter x1				

- The data are measured under the following conditions (ISO-T1, H1). Cooling: Indoor temp. of 27°CDB, 19°CWB, and outdoor temp. of 35°CDB.
- Heating: Indoor temp. of 20°CDB, and outdoor temp. of 7°CDB, 6°CWB.
- Sound level indicates the value in an anechoic chamber. During operation these values are somewhat higher due to ambient conditions.
- 'tonne(s) of CO₂ equivalent' means a quantity of greenhouse gases- expressed as the product of the weight of the greenhouse gases in metric tonnes and of their global warming potential.



SINGLE-SPLIT WALL MOUNTED TYPE



SRK-ZR-WF



SRK63,71,80,100ZR-WF



BUILT IN WIRELESS LAN



KEY FEATURES

The ZR series is the ideal solution for heating and cooling larger spaces in your home.

Key features include:

- Compact and lightweight design
- Environmentally friendly with low Global Warming Potential (GWP) and high energy efficiency thanks to the new R32 refrigerant
- Jet technology ensures quiet airflow and extended reach
- Allergen clear operation cleans the air using Mitsubishi Heavy Industries Thermal Systems' proprietary control scheme
- Wireless interface control included for added convenience

*SC-BIKN2-E cannot be used simultaneously with the Wireless LAN control system

SPECIFICATIONS

Indoor unit			SRK63ZR-WF	SRK71ZR-WF	SRK80ZR-WF	SRK100ZR-WF		
Outdoor unit			SRC63ZR-W	SRC71ZR-W	SRC80ZR-W	FDC100VNP-W		
Power source			1 Phase, 220 - 240V, 50Hz					
Nominal cooling capacity (Min-Max)		kW	6.3 (1.2 - 7.4)	7.1 (2.3 - 7.8)	8.0 (2.3 - 9.7)	9.6 (2.1 - 9.6)		
Nominal heating capacity (Min-Max)		kW	7.1 (0.8 - 9.3)	8.0 (2.0 - 10.8)	9.0 (2.1 - 11.2)	10.0 (1.7 - 10.4)		
Power consumption		Cooling/Heating	kW	1.63 / 1.64	1.93 / 1.95	2.09 / 2.27	3.10 / 2.80	
EER/COP		Cooling/Heating		3.87 / 4.33	3.68 / 4.10	3.83 / 3.96	3.10 / 3.57	
Max. running current		A	14.5	17	17	19		
Sound power level	Indoor	Cooling/Heating	dB(A)		56 / 58	57 / 60	60 / 62	63 / 63
	Outdoor	Cooling/Heating	dB(A)		64 / 65	63 / 63	67 / 67	68 / 67
Sound pressure level	Indoor	Cooling (Hi/Me/Lo/Ulo)	dB(A)		44 / 39 / 35 / 25	44 / 41 / 37 / 25	47 / 44 / 39 / 26	48 / 45 / 40 / 27
		Heating (Hi/Me/Lo/Ulo)	dB(A)		44 / 38 / 34 / 28	46 / 39 / 35 / 28	47 / 41 / 36 / 29	48 / 43 / 38 / 30
	Outdoor	Cooling/Heating	dB(A)		54 / 54	53 / 51	56 / 55	56 / 54
Air flow	Indoor	Cooling (Hi/Me/Lo/Ulo)	m ³ /min		20.5 / 18.1 / 15.7 / 10.4	20.5 / 18.6 / 16.2 / 10.4	23.5 / 20.2 / 17.5 / 10.4	24.5 / 21.3 / 17.6 / 10.4
		Heating (Hi/Me/Lo/Ulo)	m ³ /min		22.5 / 19.0 / 16.5 / 13.1	25.0 / 19.8 / 17.3 / 13.3	26.5 / 21.3 / 18.4 / 13.5	27.5 / 23.2 / 19.1 / 13.6
	Outdoor	Cooling/Heating	m ³ /min		41.5 / 41.5	55 / 43.5	63 / 49.5	63 / 55
Exterior dimensions	Indoor	Height x Width x Depth	mm				339 x 1197 x 262	
	Outdoor	Height x Width x Depth	mm		640 x 800(+71) x 290	750 x 880(+88) x 340		
Net weight		Indoor / Outdoor	kg		15.5 / 45.0	15.5 / 56.0	16.5 / 57.0	
Refrigerant		Type/GWP	R32 / 675					
		Charge	kg/TCO ₂ Eq		1.25 / 0.844	1.5 / 1.013	1.6 / 1.080	1.7 / 1.148
Refrigerant piping size		Liquid/Gas	ø mm		6.35(1/4") / 12.7(1/2")	6.35(1/4") / 15.88(5/8")		
Refrigerant line (one way) length [chargeless length]		m	Max.30 [15]					
Vertical height differences		Outdoor is higher/lower	m				Max.20 / Max.20	
Outdoor operating temperature range		Cooling	°CDB				-15 to 46	
		Heating	°CDB				-15 to 24	
Clean filter		Allergen Clear Filter x1, Photocatalytic Washable Deodorising Filter x1						

• The data are measured under the following conditions(ISO-T1, H1). Cooling: Indoor temp. of 27°CDB, 19°CWB, and outdoor temp. of 35°CDB. Heating: Indoor temp. of 20°CDB, and outdoor temp. of 7°CDB, 6°CWB.

• Sound level indicates the value in an anechoic chamber. During operation these values are somewhat higher due to ambient conditions.

• 'tonne(s) of CO₂ equivalent' means a quantity of greenhouse gases- expressed as the product of the weight of the greenhouse gases in metric tonnes and of their global warming potential.



SINGLE-SPLIT WALL MOUNTED TYPE

Diamond Series

SRK-ZR-W



SRK63,71,80,100ZR-W



OPTIONAL



Wireless remote control



SRC63ZR-W



SRC71,80ZR-W,FDC100VNP-W

KEY FEATURES

- Compact and light weighted. The 10.0kW outdoor unit is now 57kg and is 20% lighter than the previous model
- Low Global Warming Potential (GWP) and High energy efficiency by new refrigerant R32
- Quiet Air Flow & Long Reach is achieved by jet technology
- Allergen clear operation cleans air, using a control scheme owned only by Mitsubishi Heavy Industries Thermal Systems
- Wireless interface control (optional)

SPECIFICATIONS

Indoor unit			SRK63ZR-W	SRK71ZR-W	SRK80ZR-W	SRK100ZR-W
Outdoor unit			SRC63ZR-W	SRC71ZR-W	SRC80ZR-W	FDC100VNP-W
Power source			1 Phase, 220 - 240V, 50Hz			
Nominal cooling capacity (Min-Max)		kW	6.3 (1.2 - 7.4)	7.1 (2.3 - 7.8)	8.0 (2.3 - 9.7)	9.6 (2.1 - 9.6)
Nominal heating capacity (Min-Max)		kW	7.1 (0.8 - 9.3)	8.0 (2.0 - 10.8)	9.0 (2.1 - 11.2)	10.0 (1.7 - 10.4)
Power consumption		kW	Cooling/Heating		Cooling/Heating	
EER/COP			1.63 / 1.64	1.93 / 1.95	2.09 / 2.27	3.10 / 2.80
			3.87 / 4.33	3.68 / 4.10	3.83 / 3.96	3.10 / 3.57
Max. running current		A	14.5	17	17	19
Sound power level	Indoor	Cooling/Heating	dB(A)		dB(A)	
	Outdoor		56 / 58	57 / 60	60 / 62	63 / 63
			64 / 65	63 / 63	67 / 67	68 / 67
Sound pressure level	Indoor	Cooling (Hi/Me/Lo/Ulo)	dB(A)		dB(A)	
			Heating (Hi/Me/Lo/Ulo)	44 / 39 / 35 / 25	44 / 41 / 37 / 25	47 / 44 / 39 / 26
	Outdoor	Cooling/Heating	dB(A)		dB(A)	
			44 / 38 / 34 / 28	46 / 39 / 35 / 28	47 / 41 / 36 / 29	48 / 43 / 38 / 30
			54 / 54	53 / 51	56 / 55	56 / 54
Air flow	Indoor	Cooling (Hi/Me/Lo/Ulo)	m ³ /min		m ³ /min	
			Heating (Hi/Me/Lo/Ulo)	20.5 / 18.1 / 15.7 / 10.4	20.5 / 18.6 / 16.2 / 10.4	23.5 / 20.2 / 17.5 / 10.4
	Outdoor	Cooling/Heating	m ³ /min		m ³ /min	
			41.5 / 41.5	55 / 43.5	63 / 49.5	63 / 55
Exterior dimensions	Indoor	Height x Width x Depth	mm		mm	
	Outdoor		640 x 800(+71) x 290	339 x 1197 x 262	750 x 880(+88) x 340	
Net weight		Indoor / Outdoor	kg		kg	
			15.5 / 45.0	15.5 / 56.0	16.5 / 57.0	
Refrigerant		Type/GWP	R32 / 675			
		Charge	kg/TCO:Eq		kg/TCO:Eq	
			1.25 / 0.844	1.5 / 1.013	1.6 / 1.080	1.7 / 1.148
Refrigerant piping size		Liquid/Gas	ø mm		ø mm	
			6.35(1/4") / 12.7(1/2")		6.35(1/4") / 15.88(5/8")	
Refrigerant line (one way) length [chargeless length]		m	Max.30 [15]			
Vertical height differences		Outdoor is higher/lower	m			
			Max.20 / Max.20			
Outdoor operating temperature range		Cooling	°CDB			
		Heating	-15 to 46			
			-15 to 24			
Clean filter			Allergen Clear Filter x1, Photocatalytic Washable Deodorising Filter x1			

• The data are measured under the following conditions (ISO-T1, H1). Cooling: Indoor temp. of 27°CDB, 19°CWB, and outdoor temp. of 35°CDB. Heating: Indoor temp. of 20°CDB, and outdoor temp. of 7°CDB, 6°CWB.

• Sound level indicates the value in an anechoic chamber. During operation these values are somewhat higher due to ambient conditions.

• 'tonne(s) of CO₂ equivalent' means a quantity of greenhouse gases- expressed as the product of the weight of the greenhouse gases in metric tonnes and of their global warming potential.



SINGLE-SPLIT WALL MOUNTED TYPE



SRK-ZT-WF

New



SRK20,25,35,50ZT-WF

Pure White(-WF)



BUILT IN WIRELESS LAN



Black(-WFB)



Titanium & Black(-WFT)



Wireless remote control

KEY FEATURES

- Elegant, timeless design, ideal for small to medium-sized living spaces
- Available in three different colour preferences
- R32 environmentally friendly refrigerant offers low Global Warming Potential (GWP) and high energy efficiency
- Jet technology ensures quiet air flow and extended reach
- Wireless interface control is integrated as standard

SPECIFICATIONS

Indoor unit			SRK20ZT-WF,-WFB,-WFT	SRK25ZT-WF,-WFB,-WFT	SRK35ZT-WF,-WFB,-WFT	SRK50ZT-WF,-WFB,-WFT
Outdoor unit			SRC20ZT-W,-WB	SRC25ZT-W,-WB	SRC35ZT-W,-WB	SRC50ZT-W,-WB
Power source			1 Phase, 220 - 240V, 50Hz			
Nominal cooling capacity (Min-Max)		kW	2.0 (0.9 - 2.9)	2.5 (0.9 - 3.3)	3.5 (0.9 - 4.0)	5.0 (1.3 - 5.4)
Nominal heating capacity (Min-Max)		kW	2.7 (0.9 - 4.5)	3.2 (0.9 - 4.7)	4.0 (0.9 - 5.0)	5.8 (1.3 - 6.4)
Power consumption		Cooling/Heating kW	0.42 / 0.53	0.57 / 0.70	0.88 / 0.91	1.43 / 1.48
EER/COP		Cooling/Heating	4.76 / 5.09	4.39 / 4.57	3.98 / 4.40	3.50 / 3.92
Max. running current		A	9	9	9	14.5
Sound power level	Indoor	Cooling/Heating	47 / 49	50 / 52	52 / 55	59 / 59
	Outdoor	Cooling/Heating	55 / 56	56 / 58	62 / 61	63 / 63
Sound pressure level	Indoor	Cooling (Hi/Me/Lo/Ulo)	32 / 25 / 22 / 19	35 / 28 / 23 / 19	38 / 30 / 26 / 19	45 / 36 / 29 / 22
		Heating (Hi/Me/Lo/Ulo)	34 / 29 / 23 / 19	38 / 30 / 24 / 19	40 / 36 / 25 / 19	44 / 37 / 31 / 24
	Outdoor	Cooling/Heating	42 / 43	45 / 46	50 / 48	50 / 51
Air flow	Indoor	Cooling (Hi/Me/Lo/Ulo)	9.0 / 7.0 / 5.9 / 5.0	10.0 / 8.3 / 6.0 / 5.0	10.0 / 8.6 / 6.3 / 5.0	13.3 / 10.0 / 7.6 / 5.7
		Heating (Hi/Me/Lo/Ulo)	9.4 / 8.4 / 6.4 / 5.3	10.6 / 9.0 / 6.5 / 5.3	11.3 / 10.0 / 6.7 / 5.3	13.5 / 10.6 / 8.8 / 6.6
	Outdoor	Cooling/Heating	21.8 / 21.8	23.3 / 25.3	29.9 / 26.4	29.8 / 29.8
Exterior dimensions	Indoor	Height x Width x Depth	290 x 870 x 230			
	Outdoor		540 x 780(+62) x 290			
Net weight	Indoor / Outdoor	kg	10.5 / 33.0		11.0 / 33.5	11.0 / 33.0
	Refrigerant	Type/GWP	R32 / 675			
	Charge	kg/CO ₂ Eq	0.76 / 0.513		0.81 / 0.547	0.83 / 0.560
Refrigerant piping size	Liquid/Gas	ø mm	6.35(1/4") / 9.52(3/8")			
Refrigerant line (one way) length [chargeless length]		m	Max.20 [15]			
Vertical height differences	Outdoor is higher/lower	m	Max.15 / Max.15			
Outdoor operating temperature range	Cooling	°CDB	-15 to 50			
	Heating		-20 to 24			
Clean filter			Allergen Clear Filter x1, Photocatalytic Washable Deodorising Filter x1			

- The data are measured under the following conditions(ISO-T1, H1). Cooling: Indoor temp. of 27°CDB, 19°CWB, and outdoor temp. of 35°CDB. Heating: Indoor temp. of 20°CDB, and outdoor temp. of 7°CDB, 6°CWB.
- Sound level indicates the value in an anechoic chamber. During operation these values are somewhat higher due to ambient conditions.
- 'tonne(s) of CO₂ equivalent' means a quantity of greenhouse gases- expressed as the product of the weight of the greenhouse gases in metric tonnes and of their global warming potential.



Remote control

- A simple and intuitive design for effortless use
- Temperature controlled in precise 0.5°C increments
- Enhanced visibility with back-light for easy reading



SRC20,25,35ZT-WB



SRC20,25,35ZT-W



SRC50ZT-WB



SRC50ZT-W

Craftsmanship in details

- The screws are concealed beneath a cover, giving the unit a less mechanical and more refined, interior-oriented appearance.
- One of the edges lines is aligned with the upper flap, forming a single smooth, straight line from the wall across the unit.

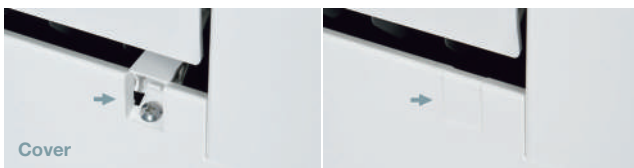

Jet black outdoor unit

- Available in a jet black colour variation, providing a bold and sophisticated presence that enhances its surroundings.





SINGLE-SPLIT WALL MOUNTED TYPE



SRK-ZTL-W



SRK15,20,25,35,50ZTL-W



BUILT IN WIRELESS LAN



SRK63,71ZTL-W



Wireless remote control



SRC15,20,25,35ZTL-W



SRC50ZTL-W



SRC63,71ZTL-W

SPECIFICATIONS

Indoor unit			SRK15ZTL-W	SRK20ZTL-W	SRK25ZTL-W	SRK35ZTL-W	
Outdoor unit			SRC15ZTL-W	SRC20ZTL-W	SRC25ZTL-W	SRC35ZTL-W	
Power source			1 Phase, 220 - 240V, 50Hz				
Nominal cooling capacity (Min-Max)		kW	1.5 (0.7 - 2.5)	2.0 (0.7 - 2.8)	2.5 (0.8 - 3.2)	3.5 (0.8 - 3.7)	
Nominal heating capacity (Min-Max)		kW	2.0 (0.9 - 4.1)	2.7 (0.9 - 4.2)	3.0 (1.0 - 4.8)	3.8 (1.0 - 4.9)	
Power consumption		Cooling/Heating	kW	0.35 / 0.42	0.51 / 0.64	0.58 / 0.66	1.05 / 0.90
EER/COP		Cooling/Heating		4.29 / 4.76	3.92 / 4.22	4.31 / 4.55	3.33 / 4.22
Max. running current		A	9.0	9.0	9.0	9.0	
Sound power level	Indoor	Cooling/Heating	51 / 53	52 / 54	55 / 55	56 / 57	
	Outdoor	Cooling/Heating	56 / 57	57 / 57	58 / 59	61 / 62	
Sound pressure level	Indoor	Cooling (Hi/Me/Lo/Ulo)	36 / 30 / 23 / 19	37 / 31 / 23 / 19	41 / 36 / 26 / 22	42 / 37 / 27 / 22	
		Heating (Hi/Me/Lo/Ulo)	38 / 32 / 24 / 19	39 / 34 / 25 / 19	41 / 36 / 29 / 22	43 / 37 / 31 / 22	
	Outdoor	Cooling/Heating	43 / 44	45 / 46	47 / 46	50 / 50	
		Air flow	Indoor	Cooling (Hi/Me/Lo/Ulo)	9.5 / 7.5 / 4.9 / 3.8	9.9 / 7.8 / 4.9 / 3.8	10.0 / 8.0 / 5.3 / 4.4
Exterior dimensions	Indoor	Height x Width x Depth	294 x 798 x 210				
	Outdoor	Height x Width x Depth	540 x 645 (+57) x 275				
Net weight		Indoor / Outdoor	kg	8.5 / 22.0		9.0 / 24.0	
Refrigerant		Type/GWP	R32 / 675				
		Charge	kg/TCO-Eq	0.43 / 0.29		0.59 / 0.40	
Refrigerant piping size		Liquid/Gas	ø mm				
			6.35 (1/4") / 9.52 (3/8")				
Refrigerant line (one way) length [chargeless length]		m	Max.20 [10]				
Vertical height differences		Outdoor is higher/lower	m				
			Max.15 / Max.15				
Outdoor operating temperature range		Cooling	°CDB				
		Heating	-15 to 46				
			-15 to 24				
Clean filter			Allergen Clear Filter x1, Photocatalytic Washable Deodorising Filter x1(option)				

- The data are measured under the following conditions(ISO-T1, H1). Cooling: Indoor temp. of 27°CDB, 19°CWB, and outdoor temp. of 35°CDB. Heating: Indoor temp. of 20°CDB, and outdoor temp. of 7°CDB, 6°CWB.
- Sound level indicates the value in an anechoic chamber. During operation these values are somewhat higher due to ambient conditions.
- 'tonne(s) of CO₂ equivalent' means a quantity of greenhouse gases- expressed as the product of the weight of the greenhouse gases in metric tonnes and of their global warming potential.



Elegant timeless design

- Designed with simplicity and elegance by an Italian design firm
- Intake is discreetly concealed when the unit is mounted
- Compact in size, offering a smaller footprint compared to the ZR-ZT series



Remote control

- Features a simple design for effortless usability
- Temperature control in precise 0.5°C increments
- Enhanced visibility with back-light for easy reading



KEY FEATURES

- Elegant timeless design with compact dimensions
- Available in small capacities down to 1.5 kW, ideal for fitting into small or well-insulated rooms
- Wireless Control System is included
- *SC-BIKN2-E cannot be used simultaneously with the Wireless LAN control system
- Remote control features a simple design for ease of use
- Offers 2 levels of silent modes to minimize outdoor unit noise
- Provides the longest pipe length and highest differential height for installation flexibility
- Lightweight outdoor unit ensures easy installation

SPECIFICATIONS

Indoor unit			SRK50ZTL-W	SRK63ZTL-W	SRK71ZTL-W
Outdoor unit			SRC50ZTL-W	SRC63ZTL-W	SRC71ZTL-W
Power source			1 Phase, 220 - 240V, 50Hz		
Nominal cooling capacity (Min-Max)		kW	5.0 (1.3 - 5.3)	6.3 (1.2 - 7.1)	7.1 (1.2 - 7.3)
Nominal heating capacity (Min-Max)		kW	5.8 (1.3 - 6.3)	7.1 (1.0 - 8.5)	8.0 (1.1 - 9.1)
Power consumption	Cooling/Heating	kW	1.59 / 1.62	1.84 / 2.01	2.45 / 2.37
	EER/COP	Cooling/Heating	3.14 / 3.58	3.42 / 3.53	2.90 / 3.38
Max. running current		A	14.5	17.0	17.0
Sound power level	Indoor	Cooling/Heating	60 / 60	60 / 61	61 / 62
	Outdoor	Cooling/Heating	64 / 65	64 / 66	66 / 66
Sound pressure level	Indoor	Cooling (Hi/Me/Lo/Ulo)	47 / 40 / 32 / 25	46 / 43 / 38 / 30	48 / 44 / 39 / 31
		Heating (Hi/Me/Lo/Ulo)	47 / 40 / 33 / 25	47 / 43 / 39 / 32	47 / 44 / 40 / 33
	Outdoor	Cooling/Heating	52 / 53	52 / 54	53 / 54
Air flow	Indoor	Cooling (Hi/Me/Lo/Ulo)	12.5 / 10.4 / 7.2 / 5.4	17.0 / 14.7 / 12.1 / 9.4	17.5 / 15.2 / 12.6 / 9.4
		Heating (Hi/Me/Lo/Ulo)	12.6 / 11.5 / 8.9 / 6.4	18.4 / 17.2 / 14.1 / 11.6	18.9 / 17.7 / 14.6 / 11.6
	Outdoor	Cooling/Heating	35.6 / 33.8	43.0 / 40.9	43.0 / 40.9
Exterior dimensions	Indoor	Height x Width x Depth	294 x 798 x 210		
	Outdoor		294 x 998 x 230		
Net weight	Indoor / Outdoor	kg	595 x 780(+62) x 290		640 x 800 (+71) x 290
			9.5 / 33.0		
Refrigerant	Type/GWP		R32 / 675		
	Charge	kg/CO ₂ Eq	0.9 / 0.61	1.20 / 0.81	
Refrigerant piping size	Liquid/Gas	ø mm	6.35 (1/4") / 12.7 (1/2")		6.35 (1/4") / 12.7 (1/2")
Refrigerant line (one way) length [chargeless length]		m	Max.25 [15]		Max.30 [15]
Vertical height differences	Outdoor is higher/lower	m	Max.20 / Max.20		Max.20 / Max.20
Outdoor operating temperature range	Cooling	°CDB	-15 to 46		
	Heating	°CDB	-15 to 24		
Clean filter			Allergen Clear Filter x1, Photocatalytic Washable Deodorising Filter x1(option)		

- The data are measured under the following conditions(ISO-T1, H1). Cooling: Indoor temp. of 27°CDB, 19°CWB, and outdoor temp. of 35°CDB. Heating: Indoor temp. of 20°CDB, and outdoor temp. of 7°CDB, 6°CWB.
- Sound level indicates the value in an anechoic chamber. During operation these values are somewhat higher due to ambient conditions.
- 'tonne(s) of CO₂ equivalent' means a quantity of greenhouse gases- expressed as the product of the weight of the greenhouse gases in metric tonnes and of their global warming potential.



SINGLE-SPLIT WALL MOUNTED TYPE



SRK-ZSP-W1



SRK25,35,45,50ZSP-W1



Wireless remote control



SRC25,35ZSP-W1



SRC45,50ZSP-W1

KEY FEATURES

The ZSP series features a compact design that is ideal for small spaces such as spare bedrooms and home offices:

- Energy class improvement. All class A⁺⁺
- Energy class improvement with all units rated A⁺⁺
- Utilizes refrigerant R32 for low Global Warming Potential (GWP) and high energy efficiency
- The compact and lightweight outdoor unit design provides excellent installation flexibility
- Includes self-cleaning operation to maintain clean room air

SPECIFICATIONS

Indoor unit			SRK25ZSP-W1	SRK35ZSP-W1	SRK45ZSP-W1	SRK50ZSP-W1	
Outdoor unit			SRC25ZSP-W1	SRC35ZSP-W1	SRC45ZSP-W1	SRC50ZSP-W1	
Power source			1 Phase, 220 - 240V, 50Hz				
Nominal cooling capacity (Min-Max)		kW	2.5 (0.8 - 3.2)	3.2 (0.9 - 3.7)	4.5 (1.3 - 4.8)	5.0 (1.3 - 5.2)	
Nominal heating capacity (Min-Max)		kW	2.8 (0.8 - 4.1)	3.6 (0.9 - 4.6)	5.0 (1.2 - 5.8)	5.6 (1.2 - 5.8)	
Power consumption		Cooling/Heating	kW	0.710 / 0.690	0.910 / 0.930	1.390 / 1.360	1.740 / 1.660
EER/COP		Cooling/Heating		3.52/4.05	3.52 / 3.87	3.23 / 3.68	2.87 / 3.37
Max. running current		A	9	9	14.5	14.5	
Sound power level	Indoor	Cooling/Heating	dB(A)	57 / 56	57 / 57	57 / 62	59 / 62
	Outdoor	Cooling/Heating	dB(A)	57 / 57	59 / 60	64 / 62	65 / 65
Sound pressure level	Indoor	Cooling (Hi/Me/Lo)	dB(A)	44 / 33 / 21	44 / 35 / 22	44 / 37 / 22	46 / 37 / 22
		Heating (Hi/Me/Lo)	dB(A)	42 / 33 / 25	44 / 35 / 27	48 / 40 / 28	48 / 40 / 28
	Outdoor	Cooling/Heating	dB(A)	47 / 45	47 / 47	51 / 51	52 / 52
		Air flow	Indoor	Cooling (Hi/Me/Lo)	m ³ /min	10.0 / 7.6 / 4.3	10.4 / 7.2 / 4.3
Exterior dimensions	Indoor	Height x Width x Depth	mm	267 x 783 x 210			
	Outdoor	Height x Width x Depth	mm	540 x 645(+57) x 275		595 x 780(+62) x 290	
Net weight		Indoor / Outdoor	kg	7.0 / 22.0	7.0 / 24.0	7.5 / 33.0	
Refrigerant		Type/GWP		R32 / 675			
		Charge	kg/TCO ₂ Eq	0.480 / 0.324	0.650 / 0.439	0.950 / 0.641	
Refrigerant piping size		Liquid/Gas	ø mm	6.35(1/4") / 9.52(3/8")			
Refrigerant line (one way) length [chargeless length]		m		Max.15 [10]	Max.15 [Not required]	Max.25 [15]	
Vertical height differences		Outdoor is higher/lower	m	Max.15 / Max.15			
Outdoor operating temperature range		Cooling	°CDB	-15 to 46			
		Heating	°CDB	-15 to 24			
Clean filter				-			

- The data are measured under the following conditions(ISO-T1, H1). Cooling: Indoor temp. of 27°CDB, 19°CWB, and outdoor temp. of 35°CDB. Heating: Indoor temp. of 20°CDB, and outdoor temp. of 7°CDB, 6°CWB.
- Sound level indicates the value in an anechoic chamber. During operation these values are somewhat higher due to ambient conditions.
- 'tonne(s) of CO₂ equivalent' means a quantity of greenhouse gases- expressed as the product of the weight of the greenhouse gases in metric tonnes and of their global warming potential.



SINGLE-SPLIT FLOOR STANDING TYPE

SRF-ZS/ZSX



SRF25,35ZS-W, 50ZSX-W

Auto air outlet selection

In case both lower and upper air outlets can be selected.



Installation workability

Piping and drain hose connection can be selected out of 6-directions.

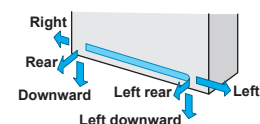

Wireless remote control



SRC25,35ZS-W2



SRC50ZSX-W2,-W3

KEY FEATURES

- The elegant semi-flat front panel in stylish white complements various room aesthetics and creates a relaxing atmosphere
- Offers options for wall hanging, floor standing, or behind-gallery installation
- Utilizes refrigerant R32 for low Global Warming Potential (GWP) and high energy efficiency
- Operates quietly with a noise level as low as 25dB(A) in cooling Ulo mode
- Includes a "flap control system" allowing users to adjust flap angles and positions according to their preference
- Equipped with an allergen-clear filter as a default feature

SPECIFICATIONS

Indoor unit			SRF25ZS-W	SRF35ZS-W	SRF50ZSX-W
Outdoor unit			SRC25ZS-W2	SRC35ZS-W2	SRC50ZSX-W2,-W3
Power source			1 Phase, 220 - 240V, 50Hz		
Nominal cooling capacity (Min-Max)		kW	2.5 (0.9 - 3.1)	3.5 (0.9 - 4.1)	5.0 (1.1 - 5.6)
Nominal heating capacity (Min-Max)		kW	2.9 (0.8 - 3.7)	4.5 (0.8 - 5.2)	6.0 (0.8 - 7.4)
Power consumption		Cooling/Heating kW	0.59 / 0.66	0.82 / 1.12	1.32 / 1.58
EER/COP		Cooling/Heating	4.24 / 4.39	4.27 / 4.02	3.79 / 3.80
Max. running current		A	9	9	15
Sound power level	Indoor	Cooling/Heating	50 / 51	51 / 52	58 / 58
	Outdoor	Cooling/Heating	59 / 60	63 / 64	63 / 62
Sound pressure level	Indoor	Cooling (Hi/Me/Lo/Ulo)	38 / 32 / 29 / 25	40 / 35 / 33 / 29	46 / 38 / 33 / 28
		Heating (Hi/Me/Lo/Ulo)	39 / 35 / 33 / 29	41 / 36 / 35 / 33	46 / 41 / 38 / 32
	Outdoor	Cooling/Heating	45 / 47	50 / 51	51 / 51
Air flow	Indoor	Cooling (Hi/Me/Lo/Ulo)	9.0 / 7.6 / 6.7 / 5.8	9.2 / 7.8 / 7.3 / 6.4	11.5 / 9.6 / 7.4 / 6.6
		Heating (Hi/Me/Lo/Ulo)	10.5 / 8.2 / 7.7 / 6.6	10.7 / 8.3 / 8.1 / 7.4	12.0 / 10.0 / 9.4 / 7.6
	Outdoor	Cooling/Heating	27.4 / 27.4	31.5 / 31.5	39.0 / 33.0
Exterior dimensions	Indoor	Height x Width x Depth	540 x 780(+62) x 290		640 x 800(+71) x 290
	Outdoor				
Net weight		Indoor / Outdoor	kg	18.0 / 31.0	19.0 / 34.5
Refrigerant	Type/GWP		R32 / 675		
	Charge	kg/CO ₂ Eq	0.62 / 0.419	0.78 / 0.527	1.30 / 0.878
Refrigerant piping size		Liquid/Gas	ø mm 6.35(1/4") / 9.52(3/8")		
Refrigerant line (one way) length [chargeless length]		m	Max.20 [10]	Max.20 [15]	Max.30 [15]
Vertical height differences		Outdoor is higher/lower	Max.10 / Max.10		Max.20 / Max.20
Outdoor operating temperature range	Cooling	°CDB	-15 to 46		
	Heating		-15 to 24		
Clean filter			Allergen Clear Filter x1, Photocatalytic Washable Deodorising Filter x1		

- The data are measured under the following conditions (ISO-T1, H1). Cooling: Indoor temp. of 27°CDB, 19°CWB, and outdoor temp. of 35°CDB. Heating: Indoor temp. of 20°CDB, and outdoor temp. of 7°CDB, 6°CWB.
- Sound level indicates the value in an anechoic chamber. During operation these values are somewhat higher due to ambient conditions.
- 'tonne(s) of CO₂ equivalent' means a quantity of greenhouse gases- expressed as the product of the weight of the greenhouse gases in metric tonnes and of their global warming potential.



SINGLE-SPLIT CEILING CONCEALED TYPE

SRR-ZS

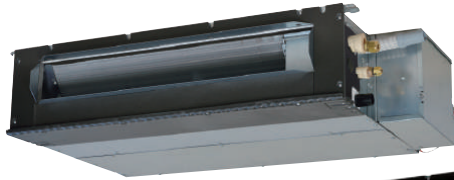

SRR25,35ZS-W



SRR50,60ZS-W



Enhanced Installation Workability

600mm Drain Pump is mounted in all models. The indoor unit is completely hidden in the ceiling, so this is suitable for spaces with classy interior decoration.

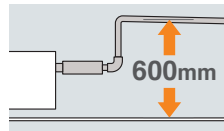

Bottom air inlet kit (optional)

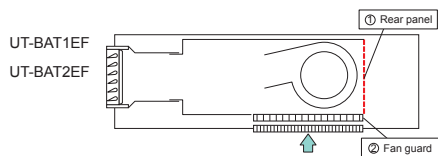

Wired remote control (optional)

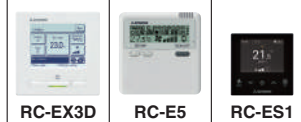

Wireless remote control



SRC25,35ZS-W2



SRC50,60ZS-W3

KEY FEATURES

- The SRR series' indoor unit is discreetly concealed under the ceiling, making it ideal for living rooms or bedroom areas
- Compact design, standing at a height of only 200mm
- Utilizes refrigerant R32 for low Global Warming Potential (GWP) and high energy efficiency
- Operates quietly for enhanced comfort
- Features low static pressure levels for efficient airflow management

SPECIFICATIONS

Indoor unit			SRR25ZS-W	SRR35ZS-W	SRR50ZS-W	SRR60ZS-W	
Outdoor unit			SRC25ZS-W2	SRC35ZS-W2	SRC50ZS-W3	SRC60ZS-W3	
Power source			1 Phase, 220 - 240V, 50Hz				
Nominal cooling capacity (Min-Max)		kW	2.5 (0.9 - 3.2)	3.5 (0.9 - 4.1)	5.0 (1.2 - 6.0)	5.6 (1.2 - 6.5)	
Nominal heating capacity (Min-Max)		kW	2.9 (0.9 - 4.4)	4.2 (1.0 - 5.2)	5.4 (1.0 - 8.2)	6.7 (1.0 - 8.6)	
Power consumption		Cooling/Heating	kW	0.62 / 0.65	0.93 / 1.01	1.42 / 1.39	1.70 / 1.89
EER/COP		Cooling/Heating		4.03 / 4.46	3.76 / 4.16	3.52 / 3.88	3.29 / 3.54
Max. running current		A	9	9	15	15	
Sound power level	Indoor	Cooling/Heating	dB(A)				
	Outdoor	Cooling/Heating	dB(A)				
Sound pressure level	Indoor	Cooling (Hi/Me/Lo/Ulo)	dB(A)				
		Heating (Hi/Me/Lo/Ulo)	dB(A)				
	Outdoor	Cooling/Heating	dB(A)				
Air flow	Indoor	Cooling (Hi/Me/Lo/Ulo)	m ³ /min				
		Heating (Hi/Me/Lo/Ulo)	m ³ /min				
	Outdoor	Cooling/Heating	m ³ /min				
External static pressure		Pa	Standard : 5 ¹ (Initial static pressure with air filter : 5Pa)				
Exterior dimensions	Indoor	Height x Width x Depth	200 x 750 x 500			200 x 950 x 500	
	Outdoor	Height x Width x Depth	540 x 780(+62) x 290			640 x 800(+71) x 290	
Net weight		Indoor / Outdoor	kg		24.0 / 45.0	24.0 / 45.0	
Refrigerant		Type/GWP	R32 / 675				
Charge		kg/TCO ₂ Eq	0.62 / 0.419		0.78 / 0.527	1.30 / 0.878	
Refrigerant piping size		Liquid/Gas	ø mm			ø mm	
Refrigerant line (one way) length [chargeless length]			Max.20 [15]			Max.30 [15]	
Vertical height differences		Outdoor is higher/lower	Max.10 / Max.10			Max.20 / Max.20	
Outdoor operating temperature range		Cooling	°CDB				
		Heating	°CDB				
Bottom air inlet kit (option)			UT-BAT1EF			UT-BAT2EF	

* The data are measured under the following conditions (ISO-T1, H1). Cooling: Indoor temp. of 27°CDB, 19°CWB, and outdoor temp. of 35°CDB. Heating: Indoor temp. of 20°CDB, and outdoor temp. of 7°CDB, 6°CWB.

• Sound level indicates the value in an anechoic chamber. During operation these values are somewhat higher due to ambient conditions.

• 'tonne(s) of CO₂ equivalent' means a quantity of greenhouse gases- expressed as the product of the weight of the greenhouse gases in metric tonnes and of their global warming potential.

*1 The maximum external static pressure can be used up to 35Pa(25•35ZS), 50Pa(50•60ZS), but the airflow will be reduced.



SINGLE-SPLIT 4WAY CEILING CASSETTE TYPE

FDTC-VH



Honeycomb type Grid type

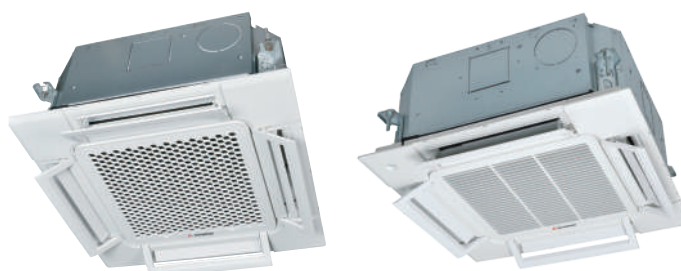

FDTC25,35VH1,
FDTC40,50,60VH



Wired remote control (optional)



Wireless remote control (optional)



RCN-TC-5AW -E3

Motion sensor (optional)



LB-TC-5W-E



SRC25, 35ZS-W2



SRC40ZSX-W1, SRC50ZSX-W2,-W3,
SRC60ZSX-W1, -W3

KEY FEATURES

- Height of the thin panel and the main body is only 248mm allowing a very easy installation. Integrated ceiling system design (600×600mm)
- Low Global Warming Potential (GWP) and high energy efficiency by new refrigerant R32
- Draft Prevention Panel (optional) prevents cold/hot draft from being blown directly on the user. Draft Prevention Panel could be installed for each air outlet
- Motion sensor (optional) is an energy saving operation function that detects human movement and saves energy
- Noise has been reduced by adopting a new turbo fan and improving the heat exchanger

SPECIFICATIONS

Indoor unit			FDTC25VH1	FDTC35VH1	FDTC40VH	FDTC50VH	FDTC60VH		
Outdoor unit			SRC25ZS-W2	SRC35ZS-W2	SRC40ZSX-W1	SRC50ZSX-W2,-W3	SRC60ZSX-W1,-W3		
Power source			1 Phase, 220 - 240V, 50Hz						
Nominal cooling capacity (Min-Max)		kW	2.5 (0.9 - 3.2)	3.5 (0.9 - 4.3)	4.0 (1.1 - 4.7)	5.0 (1.1 - 5.6)	5.6 (1.1 - 6.3)		
Nominal heating capacity (Min-Max)		kW	2.9 (0.9 - 4.0)	4.25 (0.9 - 4.6)	4.5 (0.6 - 5.4)	5.4 (0.6 - 6.3)	6.7 (0.6 - 6.7)		
Power consumption		kW	Cooling/Heating		Cooling/Heating		Cooling/Heating		
EER/COP			4.10 / 4.08	3.85 / 3.70	4.08 / 3.98	3.58 / 3.53	3.23 / 3.13		
Max. running current		A	9	9	15	15	15		
Sound power level	Indoor	Cooling/Heating	dB(A)	51 / 52		59 / 59		60 / 60	
	Outdoor			58 / 59		62 / 62		63 / 62	
Sound pressure level	Indoor	Cooling (Hi/Me/Lo/Ulo)	dB(A)	38 / 34 / 30 / 27		39 / 36 / 32 / 29		44 / 40 / 35 / 27	
	Outdoor			39 / 36 / 32 / 28		41 / 38 / 34 / 30		44 / 40 / 35 / 27	
Air flow	Indoor	Cooling (Hi/Me/Lo/Ulo)	m ³ /min	8.5 / 7.5 / 7.0 / 6.0		9.0 / 8.0 / 7.5 / 6.5		13 / 11 / 9 / 7	
	Outdoor			9.5 / 8.5 / 7.5 / 6.5		10.0 / 9.0 / 8.0 / 7.0		13 / 11 / 9 / 7	
Exterior dimensions	Indoor	Height x Width x Depth	mm	Unit : 248 x 570 x 570 Panel : 10 x 620 x 620					
	Outdoor			540 x 780(+62) x 290		640 x 800(+71) x 290			
Net weight	Indoor		kg	16.0 (Unit : 13.5 Panel : 2.5)		16.5 (Unit : 14 Panel : 2.5)			
	Outdoor			31.0		34.5			
Refrigerant	Type/GWP	kg/TCO ₂ Eq	R32 / 675						
	Charge		0.62 / 0.419 0.78 / 0.527 1.30 / 0.878						
Refrigerant piping size	Liquid/Gas	ø mm	6.35(1/4") / 9.52(3/8")		6.35(1/4") / 12.7(1/2")				
Refrigerant line (one way) length [chargeless length]		m	Max.20 [15]		Max.30 [15]				
Vertical height differences	Outdoor is higher/lower	m	Max.10 / Max.10		Max.20 / Max.20				
Outdoor operating temperature range	Cooling	°CDB	-15 to 24		-15 to 46				
	Heating		-20 to 20						
Panel		Standard Panel : TC-PSA-5AW-E(Honeycomb), TC-PSAG-5AW-E(Grid) Draft Prevention Panel : TC-PSAE-5AW-E(Honeycomb), TC-PSAGE-5AW-E(Grid)							

• The data are measured under the following conditions (ISO-T1, H1). Cooling: Indoor temp. of 27°CDB, 19°CWB, and outdoor temp. of 35°CDB. Heating: Indoor temp. of 20°CDB, and outdoor temp. of 7°CDB, 6°CWB.
 • Sound level indicates the value in an anechoic chamber. During operation these values are somewhat higher due to ambient conditions.
 • 'tonne(s) of CO₂ equivalent' means a quantity of greenhouse gases- expressed as the product of the weight of the greenhouse gases in metric tonnes and of their global warming potential.



SINGLE-SPLIT WALL MOUNTED TYPE



SRK-ZSX-S



SRK20,25,35,50,60ZSX-S



OPTIONAL



Wireless remote control



SRC20,25,35,50,60ZSX-S

KEY FEATURES

- Elegant timeless design
- High seasonal efficiency performance up to A+++ in cooling and heating
- Quiet air flow and extended reach achieved through jet technology
- Allergen-clear operation cleans air using Mitsubishi Heavy Industries Thermal Systems' proprietary control scheme
- Optional wireless interface control

SPECIFICATIONS

Indoor unit			SRK20ZSX-S	SRK25ZSX-S	SRK35ZSX-S	SRK50ZSX-S	SRK60ZSX-S	
Outdoor unit			SRC20ZSX-S	SRC25ZSX-S	SRC35ZSX-S	SRC50ZSX-S	SRC60ZSX-S	
Power source			1Phase, 220 - 240V, 50Hz					
Nominal cooling capacity (Min-Max)		kW	2.0 (0.9 - 3.2)	2.5 (0.9 - 3.7)	3.5 (0.9 - 4.3)	5.0 (1.0 - 5.8)	6.1 (1.0 - 6.8)	
Nominal heating capacity (Min-Max)		kW	2.7 (0.8 - 5.3)	3.2 (0.8 - 5.8)	4.3 (0.8 - 6.6)	6.0 (0.6 - 8.1)	6.8 (0.6 - 8.7)	
Power consumption		Cooling/Heating	kW		0.32 / 0.47	0.44 / 0.59	0.78 / 0.90	1.30 / 1.36
EER/COP		Cooling/Heating	6.25 / 5.74		5.68 / 5.42	4.49 / 4.78	3.85 / 4.41	3.37 / 4.07
Max. running current		A	9		9	15	15	
Sound power level	Indoor	Cooling/Heating	dB(A)		53 / 53	55 / 56	58 / 58	59 / 62
	Outdoor	Cooling/Heating	56 / 58		57 / 58	61 / 62	63 / 63	65 / 64
Sound pressure level	Indoor	Cooling (Hi/Me/Lo/Ulo)	dB(A)		38 / 31 / 24 / 19	39 / 33 / 25 / 19	43 / 35 / 26 / 19	44 / 39 / 31 / 22
		Heating (Hi/Me/Lo/Ulo)	38 / 32 / 25 / 19		40 / 34 / 27 / 19	41 / 35 / 28 / 19	46 / 41 / 33 / 23	46 / 42 / 34 / 23
	Outdoor	Cooling/Heating	43 / 44		44 / 45	48 / 47	50 / 49	52 / 52
		Air flow	Indoor	Cooling (Hi/Me/Lo/Ulo)	m ³ /min		11.3 / 9.1 / 6.0 / 5.0	12.2 / 10.0 / 6.7 / 5.0
		Outdoor	Cooling/Heating	31.0 / 31.0		31.0 / 31.0	36.0 / 31.0	39.0 / 33.0
Exterior dimensions		Indoor / Outdoor	Height x Width x Depth		mm		305 x 920 x 220	
Net weight		Indoor / Outdoor	kg		13.0 / 43.0		640 x 800(+71) x 290	
Refrigerant		Type/GWP	R410A / 2088					
		Charge	kg/TCO-Eq		1.45 / 3.028		1.50 / 3.132	
Refrigerant piping size		Liquid/Gas	ø mm		6.35(1/4") / 9.52(3/8")		6.35(1/4") / 12.7(1/2")	
Refrigerant line (one way) length [chargeless length]		m	Max.25 [15]				Max.30 [15]	
Vertical height differences		Outdoor is higher/lower	m		Max.15 / Max.15		Max.20 / Max.20	
Outdoor operating temperature range		Cooling	°CDB		-15 to 46			
		Heating			-20 to 24			
Clean filter		Allergen Clear Filter x1, Photocatalytic Washable Deodorising Filter x1						

- The data are measured under the following conditions(ISO-T1, H1). Cooling: Indoor temp. of 27°CDB, 19°CWB, and outdoor temp. of 35°CDB.
- Heating: Indoor temp. of 20°CDB, and outdoor temp. of 7°CDB, 6°CWB.
- Sound level indicates the value in an anechoic chamber. During operation these values are somewhat higher due to ambient conditions.
- 'tonne(s) of CO₂ equivalent' means a quantity of greenhouse gases- expressed as the product of the weight of the greenhouse gases in metric tonnes and of their global warming potential.



SINGLE-SPLIT WALL MOUNTED TYPE



SRK-ZR-S



SRK63,71,80,100ZR-S



OPTIONAL



Wireless remote control



SRC63ZR-S



SRC71,80ZR-S



FDC100VNP

KEY FEATURES

- High seasonal efficiency performance up to A+++ in cooling and heating
- Quiet air flow and extended reach achieved through jet technology
- Allergen-clear operation cleans air using Mitsubishi Heavy Industries Thermal Systems' proprietary control scheme
- Optional wireless interface control

SPECIFICATIONS

Indoor unit			SRK63ZR-S	SRK71ZR-S	SRK80ZR-S	SRK100ZR-S
Outdoor unit			SRC63ZR-S	SRC71ZR-S	SRC80ZR-S	FDC100VNP
Power source			1 Phase, 220 - 240V, 50Hz			
Nominal cooling capacity (Min-Max)		kW	6.3 (1.2 - 7.1)	7.1 (2.3 - 7.7)	8.0 (2.3 - 9.0)	10.0 (2.4 - 10.5)
Nominal heating capacity (Min-Max)		kW	7.1 (0.8 - 9.0)	8.0 (2.0 - 10.0)	9.0 (2.1 - 10.5)	11.2 (3.2 - 11.5)
Power consumption		kW	Cooling/Heating		Cooling/Heating	
EER/COP			3.41 / 4.08	3.46 / 3.88	3.40 / 3.75	3.24 / 3.41
Max. running current		A	14.5	17	17	21
Sound power level	Indoor	Cooling/Heating	dB(A)		dB(A)	
	Outdoor		58 / 58	58 / 60	62 / 62	63 / 63
Sound pressure level	Indoor	Cooling/Heating	dB(A)		dB(A)	
			Cooling (Hi/Me/Lo/Ulo)	44 / 39 / 35 / 25	44 / 41 / 37 / 25	47 / 44 / 39 / 26
	Outdoor	Cooling/Heating	dB(A)		dB(A)	
			Cooling (Hi/Me/Lo/Ulo)	44 / 38 / 34 / 28	46 / 39 / 35 / 28	47 / 41 / 36 / 29
Air flow	Indoor	Cooling/Heating	m ³ /min		m ³ /min	
Exterior dimensions	Indoor	Height x Width x Depth	mm		mm	
	Outdoor		640 x 800(+71) x 290	750 x 880(+88) x 340	845 x 970 x 370	
Net weight		Indoor / Outdoor	kg		kg	
Refrigerant		Type/GWP	R410A / 2088			
Refrigerant piping size		Liquid/Gas	ø mm		ø mm	
Refrigerant line (one way) length [chargeless length]		m	Max.30 [15]			
Vertical height differences		Outdoor is higher/lower	m			
Outdoor operating temperature range		Cooling	-15 to 46			
Clean filter		Heating	-15 to 24			
Allergen Clear Filter x1, Photocatalytic Washable Deodorising Filter x1						

• The data are measured under the following conditions (ISO-T1, H1). Cooling: Indoor temp. of 27°CDB, 19°CWB, and outdoor temp. of 35°CDB. Heating: Indoor temp. of 20°CDB, and outdoor temp. of 7°CDB, 6°CWB.

• Sound level indicates the value in an anechoic chamber. During operation these values are somewhat higher due to ambient conditions.

• 'tonne(s) of CO₂ equivalent' means a quantity of greenhouse gases- expressed as the product of the weight of the greenhouse gases in metric tonnes and of their global warming potential.



SINGLE-SPLIT WALL MOUNTED TYPE

Premium Series

SRK-ZS-S



SRK20,25,35,50ZS-S

Pure White(-S)

Colour variation available

Users can choose their favourite colour from three choices.



OPTIONAL



Black & White (-SB)



Titanium (-ST)



Wireless remote control



SRC20,25,35ZS-S



SRC50ZS-S

KEY FEATURES

- Elegant timeless design available in three different colour choices
- Quiet air flow and extended reach achieved through jet technology
- Allergen-clear operation cleans air using Mitsubishi Heavy Industries Thermal Systems' proprietary control scheme
- Optional wireless interface control

SPECIFICATIONS

Indoor unit			SRK20ZS-S,-SB,-ST	SRK25ZS-S,-SB,-ST	SRK35ZS-S,-SB,-ST	SRK50ZS-S,-SB,-ST
Outdoor unit			SRC20ZS-S	SRC25ZS-S	SRC35ZS-S	SRC50ZS-S
Power source			1 Phase, 220 - 240V, 50Hz			
Nominal cooling capacity (Min-Max)		kW	2.0 (1.0 - 2.8)	2.5 (1.0 - 3.0)	3.5 (1.0 - 3.8)	5.0 (1.7 - 5.5)
Nominal heating capacity (Min-Max)		kW	2.7 (0.9 - 4.2)	3.2 (0.9 - 4.4)	4.0 (0.9 - 4.8)	5.8 (1.6 - 6.6)
Power consumption		Cooling/Heating	0.44 / 0.62	0.62 / 0.80	1.01 / 1.00	1.56 / 1.59
EER/COP		Cooling/Heating	4.55 / 4.35	4.03 / 4.00	3.47 / 4.00	3.21 / 3.65
Max. running current		A	9	9	9	14.5
Sound power level	Indoor	Cooling/Heating	50 / 52	52 / 55	56 / 58	58 / 59
	Outdoor	Cooling/Heating	57 / 57	58 / 58	62 / 61	62 / 63
Sound pressure level	Indoor	Cooling (Hi/Me/Lo/Ulo)	34 / 25 / 22 / 19	36 / 28 / 23 / 19	40 / 30 / 26 / 19	45 / 36 / 28 / 22
	Outdoor	Heating (Hi/Me/Lo/Ulo)	36 / 29 / 23 / 19	39 / 30 / 24 / 19	41 / 36 / 25 / 19	45 / 37 / 31 / 24
Air flow	Indoor	Cooling/Heating	45 / 45	46 / 46	50 / 48	51 / 53
	Outdoor	Cooling (Hi/Me/Lo/Ulo)	9.3 / 7.0 / 5.9 / 5.0	9.9 / 8.0 / 5.9 / 5.0	11.3 / 8.7 / 7.0 / 5.0	12.1 / 9.9 / 7.4 / 5.9
Exterior dimensions	Indoor	Height x Width x Depth	290 x 870 x 230			
	Outdoor	Height x Width x Depth	540 x 780(+62) x 290			595 x 780(+62) x 290
Net weight		Indoor / Outdoor	9.5 / 31.5		9.5 / 34.5	10.0 / 36.5
Refrigerant		Type/GWP	R410A / 2088			
		Charge	0.75 / 1.566		0.95 / 1.984	1.25 / 2.61
Refrigerant piping size		Liquid/Gas	ø mm		6.35(1/4") / 9.52(3/8")	
Refrigerant line (one way) length [chargeless length]		m	Max.20 [15]		Max.25 [15]	
Vertical height differences		Outdoor is higher/lower	Max.10 / Max.10		Max.15 / Max.15	
Outdoor operating temperature range		Cooling	-15 to 46			
		Heating	-15 to 24			
Clean filter			Allergen Clear Filter x1, Photocatalytic Washable Deodorising Filter x1			

* The data are measured under the following conditions(ISO-T1, H1). Cooling: Indoor temp. of 27°CDB, 19°CWB, and outdoor temp. of 35°CDB. Heating: Indoor temp. of 20°CDB, and outdoor temp. of 7°CDB, 6°CWB.

* Sound level indicates the value in an anechoic chamber. During operation these values are somewhat higher due to ambient conditions.

* 'tonne(s) of CO₂ equivalent' means a quantity of greenhouse gases- expressed as the product of the weight of the greenhouse gases in metric tonnes and of their global warming potential.



SINGLE-SPLIT WALL MOUNTED TYPE

Standard Series **SRK-ZSP-S**



SRK25,35,45ZSP-S



Wireless remote control



SRC25,35ZSP-S



SRC45ZSP-S

KEY FEATURES

- The ZSP series boasts an elegant design that complements any interior decoration
- Its compact and lightweight outdoor unit provides excellent installation flexibility
- Includes a self-cleaning operation to maintain clean room air
- Features a useful timer function for presetting air-conditioner on/off times

SPECIFICATIONS

Indoor unit			SRK25ZSP-S	SRK35ZSP-S	SRK45ZSP-S
Outdoor unit			SRC25ZSP-S	SRC35ZSP-S	SRC45ZSP-S
Power source			1 Phase, 220 - 240V, 50Hz		
Nominal cooling capacity (Min-Max)		kW	2.5 (0.9 - 2.8)	3.2 (0.9 - 3.5)	4.5 (0.9 - 4.8)
Nominal heating capacity (Min-Max)		kW	2.8 (0.8 - 3.9)	3.6 (0.9 - 4.3)	5.0 (0.8 - 5.8)
Power consumption		kW	0.78 / 0.755	0.995 / 0.995	1.495 / 1.385
EER/COP		Cooling/Heating	3.21 / 3.71	3.22 / 3.62	3.01 / 3.61
Max. running current		A	9	9	14
Sound power level	Indoor	Cooling/Heating	58 / 57	59 / 58	58 / 62
	Outdoor	Cooling/Heating	58 / 59	60 / 60	63 / 64
Sound pressure level	Indoor	Cooling (Hi/Me/Lo)	45 / 34 / 23	45 / 36 / 23	44 / 39 / 24
		Heating (Hi/Me/Lo)	43 / 34 / 26	44 / 36 / 28	48 / 41 / 30
	Outdoor	Cooling/Heating	47 / 45	47 / 48	51 / 51
		Cooling (Hi/Me/Lo)	10.0 / 7.3 / 4.2	9.5 / 6.8 / 4.2	9.0 / 7.2 / 3.8
Air flow	Indoor	Heating (Hi/Me/Lo)	9.5 / 7.3 / 5.2	9.6 / 7.4 / 5.5	12.0 / 9.2 / 6.2
	Outdoor	Cooling/Heating	26.0 / 19.7	25.4 / 20.5	35.5 / 33.5
Exterior dimensions	Indoor	Height x Width x Depth	267 x 783 x 210		
	Outdoor		540 x 645(+57) x 275	595 x 780(+62) x 290	
Net weight	Indoor / Outdoor	kg	7.0 / 25.0	7.0 / 27.0	7.5 / 40.0
	Refrigerant	Type/GWP	R410A / 2088		
Refrigerant piping size	Charge	kg/TCO _{Eq}	0.655 / 1.368	0.81 / 1.691	1.20 / 2.506
	Liquid/Gas	ø mm	6.35(1/4") / 9.52(3/8")		
Refrigerant line (one way) length [chargeless length]		m	Max.15 [10]	Max.15 [Not required]	Max.25 [15]
Vertical height differences		Outdoor is higher/lower	Max.10 / Max.10		
Outdoor operating temperature range	Cooling	°CDB	-15 to 46		
	Heating	°CDB	-15 to 24		
Clean filter			-		

• The data are measured under the following conditions (ISO-T1, H1). Cooling: Indoor temp. of 27°CDB, 19°CWB, and outdoor temp. of 35°CDB. Heating: Indoor temp. of 20°CDB, and outdoor temp. of 7°CDB, 6°CWB.
 • Sound level indicates the value in an anechoic chamber. During operation these values are somewhat higher due to ambient conditions.
 • 'tonne(s) of CO₂ equivalent' means a quantity of greenhouse gases- expressed as the product of the weight of the greenhouse gases in metric tonnes and of their global warming potential.



SINGLE-SPLIT FLOOR STANDING TYPE

SRF-ZMX



SRF25,35,50ZMX-S



Wireless remote control



SRC25,35ZMX-S



SRC50ZSX-S

Auto air outlet selection

In case both lower and upper air outlets can be selected.



KEY FEATURES

- The elegant semi flat front panel in stylish white, fit various kinds of rooms and create relaxing atmosphere
- Choice from wall hanging, floor standing or behind gallery installation
- Quiet operation. By optimising the balance of the air outlet direction and the sufficient air flow volume, the sound level has been minimised
- The "flap control system" allows users to change flap angles and positions according to their preference. Flaps can be set at different angles
- Allergen clear filter is equipped as a default

Installation workability

Piping and drain hose connection can be selected out of 6-directions.

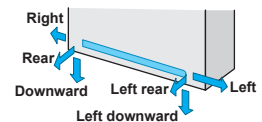

SPECIFICATIONS

Indoor unit			SRF25ZMX-S	SRF35ZMX-S	SRF50ZMX-S
Outdoor unit			SRC25ZMX-S	SRC35ZMX-S	SRC50ZSX-S
Power source			1 Phase, 220 - 240V, 50Hz		
Nominal cooling capacity (Min-Max)		kW	2.5 (0.9 - 3.2)	3.5 (0.9 - 4.1)	5.0 (1.1 - 5.2)
Nominal heating capacity (Min-Max)		kW	3.4 (0.9 - 4.7)	4.5 (0.9 - 5.1)	6.0 (0.6 - 6.9)
Power consumption		Cooling/Heating	0.521 / 0.723	0.890 / 1.124	1.390 / 1.540
EER/COP		Cooling/Heating	4.80 / 4.70	3.93 / 4.00	3.60 / 3.90
Max. running current		A	8	8	15
Sound power level	Indoor	Cooling/Heating	51 / 51	52 / 52	58 / 58
	Outdoor	Cooling/Heating	60 / 60	63 / 62	63 / 62
Sound pressure level	Indoor	Cooling (Hi/Me/Lo/Ulo)	40 / 32 / 30 / 26	41 / 34 / 33 / 28	46 / 42 / 35 / 32
		Heating (Hi/Me/Lo/Ulo)	40 / 35 / 33 / 28	41 / 36 / 35 / 31	47 / 41 / 39 / 33
	Outdoor	Cooling/Heating	47 / 47	50 / 50	52 / 51
		Cooling (Hi/Me/Lo/Ulo)	9.0 / 7.6 / 6.7 / 5.8	9.2 / 7.8 / 7.3 / 6.4	11.5 / 9.6 / 7.4 / 6.6
Air flow	Outdoor	Heating (Hi/Me/Lo/Ulo)	10.5 / 8.2 / 7.7 / 6.6	10.7 / 8.3 / 8.1 / 7.4	12.0 / 10.0 / 9.4 / 7.6
		Cooling/Heating	29.5 / 27.0	32.5 / 29.5	39.0 / 33.0
Exterior dimensions	Indoor	Height x Width x Depth	600 x 860 x 238		
	Outdoor		595 x 780(+62) x 290	640 x 800(+71) x 290	
Net weight	Indoor / Outdoor	kg	18.0 / 35.0	19.0 / 35.0	19.0 / 45.0
	Refrigerant	Type/GWP	R410A / 2088		
	Charge	kg/TCO ₂ Eq	1.2 / 2.506		
Refrigerant piping size	Liquid/Gas	ø mm	6.35(1/4") / 9.52(3/8")		
Refrigerant line (one way) length [chargeless length]		m	Max.15 [Not required]		
Vertical height differences	Outdoor is higher/lower	m	Max.10 / Max.10		
Outdoor operating temperature range	Cooling	°CDB	-15 to 46		
	Heating		-15 to 24		
Clean filter			Allergen Clear Filter x1, Photocatalytic Washable Deodorising Filter x1		

* The data are measured under the following conditions (ISO-T1, H1). Cooling: Indoor temp. of 27°CDB, 19°CWB, and outdoor temp. of 35°CDB. Heating: Indoor temp. of 20°CDB, and outdoor temp. of 7°CDB, 6°CWB.
 * Sound level indicates the value in an anechoic chamber. During operation these values are somewhat higher due to ambient conditions.
 * 'tonne(s) of CO₂ equivalent' means a quantity of greenhouse gases- expressed as the product of the weight of the greenhouse gases in metric tonnes and of their global warming potential.



SINGLE-SPLIT CEILING CONCEALED TYPE

SRR-ZM

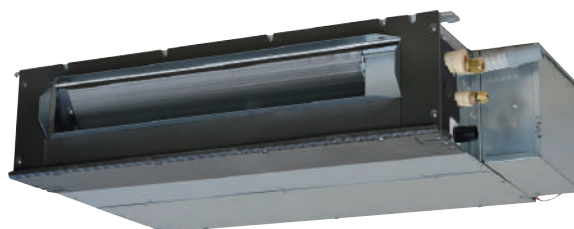

SRR25,35ZM-S

Bottom air inlet kit (option)

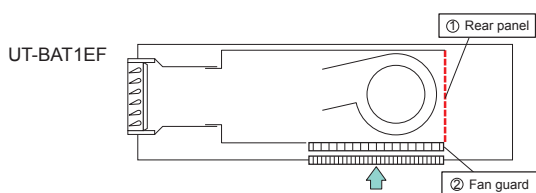

Wireless remote control



SRC25,35ZMX-S

KEY FEATURES

- Thin design with a height of only 200mm across all SRR models, ideal for spaces with elegant interior decoration where the indoor unit is completely hidden in the ceiling
- Reduced noise levels for enhanced comfort
- Low static pressure levels ensure efficient airflow
- The SRR series includes a built-in drain pump for added convenience

SPECIFICATIONS

Indoor unit				SRR25ZM-S	SRR35ZM-S
Outdoor unit				SRC25ZMX-S	SRC35ZMX-S
Power source				1 Phase, 220 - 240V, 50Hz	
Nominal cooling capacity (Min-Max)		kW		2.5 (1.0 - 3.3)	3.5 (1.0 - 3.9)
Nominal heating capacity (Min-Max)		kW		3.4 (1.4 - 4.8)	4.2 (1.5 - 5.2)
Power consumption		Cooling/Heating		kW	
EER/COP		Cooling/Heating		4.39 / 4.53	
Max. running current		A		8	
Sound power level	Indoor	Cooling/Heating	dB(A)	56 / 59	
	Outdoor	Cooling/Heating		60 / 60	
Sound pressure level	Indoor	Cooling (Hi/Me/Lo/Ulo)	dB(A)	37 / 33 / 30 / 24	
	Indoor	Heating (Hi/Me/Lo/Ulo)		40 / 37 / 34 / 28	
Air flow	Outdoor	Cooling/Heating	m ³ /min	47 / 47	
	Indoor	Cooling (Hi/Me/Lo/Ulo)		9.5 / 8.0 / 6.5 / 4.5	
External static pressure	Indoor	Heating (Hi/Me/Lo/Ulo)	Pa	10.0 / 9.0 / 8.0 / 6.0	
	Outdoor	Cooling/Heating		29.5 / 27.0	
Exterior dimensions		Height x Width x Depth		Standard : 5* ¹ (Initial static pressure with air filter : 5Pa)	
Net weight	Indoor	mm		200 x 750 x 500	
	Outdoor	mm		595 x 780(+62) x 290	
Refrigerant		Type/GWP		20.5 / 35.0	
Refrigerant piping size		Charge		R410A / 2088	
Refrigerant line (one way) length [chargeless length]		Liquid/Gas		1.2 / 2.506	
Vertical height differences		ø mm		6.35(1/4") / 9.52(3/8")	
Outdoor operating temperature range		m		Max.15 [Not required]	
Bottom air inlet kit (option)		m		Max.10 / Max.10	
		°CDB		-15 to 46	
		°CDB		-15 to 24	
				UT-BAT1EF	

• The data are measured under the following conditions (ISO-T1, H1). Cooling: Indoor temp. of 27°CDB, 19°CWB, and outdoor temp. of 35°CDB. Heating: Indoor temp. of 20°CDB, and outdoor temp. of 7°CDB, 6°CWB.
 • Sound level indicates the value in an anechoic chamber. During operation these values are somewhat higher due to ambient conditions.
 • 'tonne(s) of CO₂ equivalent' means a quantity of greenhouse gases- expressed as the product of the weight of the greenhouse gases in metric tonnes and of their global warming potential.

¹ The maximum external static pressure can be used up to 35Pa, but the airflow will be reduced.



SINGLE-SPLIT 4WAY CEILING CASSETTE TYPE

FDTC-VF

FDTC25,35,40,50,60VF

Fits into standard
600x600 ceiling



Individual flap control system

According to room temperature conditions, four directions of air flow can be controlled by individual flap as preferred. Individual flap control is available even after installation.



600mm Drain Pump is mounted

Drain can be discharged upward by 600mm from the ceiling surface close to the indoor unit. It allows a piping layout with a high degree of freedom depending on the installation location.

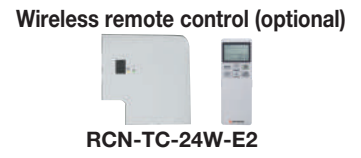
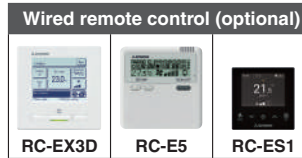
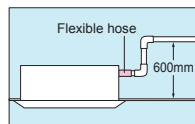

SRC25,35ZMX-S



SRC40,50,60ZSX-S

KEY FEATURES

- Compact and extra thin design
- The flap can swing within the range of upper and lower flap position selected with the wired remote control
- For wireless control, simply insert the infrared receiver kit on the corner of the panel
- FDTC-VF series come with a built in 600mm drain pumps

SPECIFICATIONS

Indoor unit			FDTC25VF	FDTC35VF	FDTC40VF	FDTC50VF	FDTC60VF	
Outdoor unit			SRC25ZMX-S	SRC35ZMX-S	SRC40ZSX-S	SRC50ZSX-S	SRC60ZSX-S	
Power source			1 Phase, 220 - 240V, 50Hz					
Nominal cooling capacity (Min-Max)		kW	2.55 (0.9 - 3.2)	3.6 (0.9 - 4.1)	4.0 (1.1 - 4.7)	5.0 (1.1 - 5.6)	5.6 (1.1 - 6.3)	
Nominal heating capacity (Min-Max)		kW	3.45 (0.9 - 4.7)	4.25 (0.9 - 5.1)	4.5 (0.6 - 5.4)	5.4 (0.6 - 6.3)	6.7 (0.6 - 6.7)	
Power consumption		Cooling/Heating	kW		0.6 / 0.84	1.07 / 1.16	1.04 / 1.10	1.56 / 1.45
EER/COP		Cooling/Heating	4.25 / 4.11		3.36 / 3.66	3.85 / 4.09	3.21 / 3.72	2.81 / 3.24
Max. running current		A	9	9	12	15	15	
Sound power level	Indoor	Cooling/Heating	dB(A)		56 / 56	58 / 58	60 / 60	60 / 60
	Outdoor	Cooling/Heating	56 / 56		58 / 58	63 / 63	63 / 63	65 / 65
Sound pressure level	Indoor	Cooling (P-Hi/Hi/Me/Lo)	dB(A)		38 / 36 / 32 / 29	41 / 40 / 36 / 30	47 / 42 / 36 / 30	47 / 42 / 36 / 30
	Outdoor	Heating (P-Hi/Hi/Me/Lo)	39 / 38 / 33 / 29.5		43 / 42 / 35 / 32	47 / 42 / 36 / 32	47 / 42 / 36 / 32	47 / 46 / 39 / 32
Air flow	Indoor	Cooling/Heating	m ³ /min		47 / 47	50 / 50	50 / 49	50 / 49
	Outdoor	Cooling (P-Hi/Hi/Me/Lo)	10 / 9 / 8 / 6.5		11 / 9.5 / 9 / 7	13.5 / 11.5 / 9 / 7	13.5 / 11.5 / 9 / 7	13.5 / 11.5 / 9 / 7
Exterior dimensions	Indoor	Height x Width x Depth	mm		29.5 / 29.5	32.5 / 29.5	36 / 33	40 / 33
	Outdoor	Height x Width x Depth	595 x 780(+62) x 290		640 x 800(+71) x 290		640 x 800(+71) x 290	
Net weight		Indoor / Outdoor	kg		18.5 (Unit : 15 Panel : 3.5) / 35.0	18.5 (Unit : 15 Panel : 3.5) / 45.0		
Refrigerant		Type/GWP	R410A / 2088		R410A / 2088		R410A / 2088	
		Charge	kg/TCO-Eq		1.2 / 2.506		1.5 / 3.132	
Refrigerant piping size		Liquid/Gas	ø mm		6.35(1/4") / 9.52(3/8")		6.35(1/4") / 12.7(1/2")	
Refrigerant line (one way) length [chargeless length]		m	Max.15 [Not required]		Max.30 [15]		Max.30 [15]	
Vertical height differences		Outdoor is higher/lower	m		Max.10 / Max.10		Max.20 / Max.20	
Outdoor operating temperature range		Cooling	°CDB		-15 to 46		-15 to 46	
		Heating	-15 to 24		-20 to 20		-20 to 20	
Panel			TC-PSA-25W-E					

* The data are measured under the following conditions (ISO-T1, H1). Cooling: Indoor temp. of 27°CDB, 19°CWB, and outdoor temp. of 35°CDB. Heating: Indoor temp. of 20°CDB, and outdoor temp. of 7°CDB, 6°CWB.
 * Sound level indicates the value in an anechoic chamber. During operation these values are somewhat higher due to ambient conditions.
 * 'tonne(s) of CO₂ equivalent' means a quantity of greenhouse gases- expressed as the product of the weight of the greenhouse gases in metric tonnes and of their global warming potential.

MULTI-SPLIT SCM

Mitsubishi Heavy Industries Thermal Systems' Multi DC Inverter range is an innovative series of Multi-split systems that redefine air-conditioning comfort across diverse environments. This advanced system allows a single outdoor unit to effectively air-condition up to 6 different rooms, employing a selection of compact and stylish indoor units available in 6 different types. Renowned for its unparalleled flexibility, high energy efficiency, and exceptionally low noise levels, this range delivers superior air-conditioning performance tailored for a variety of indoor settings.



A wide variety of choices for indoor units

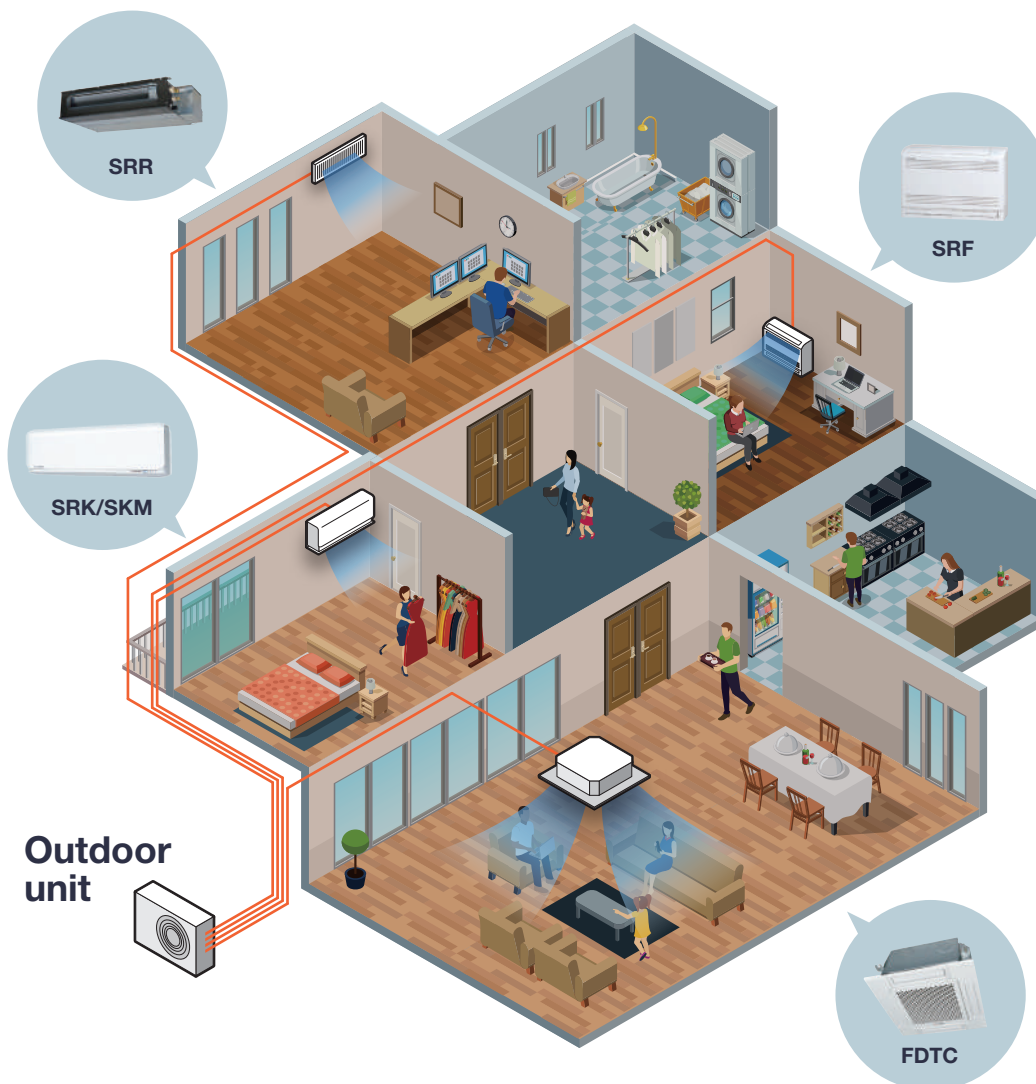



MULTI-SPLIT SYSTEM

Various line up of High energy efficient models

The small capacity models have been added to the energy efficient R32 lineup.
The added models is connectable to small capacity indoor units for 2-3 rooms

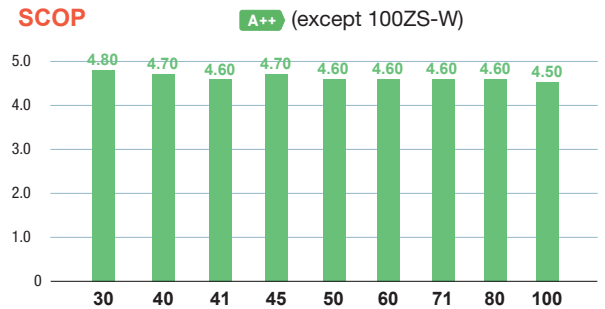
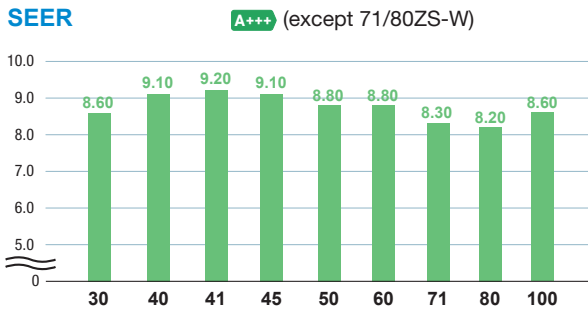

* The above values are based on indoor units combination with SRK-ZSX-W only. SCM30ZS-W, SCM41ZS-W and SCM100ZS-W are calculated in the combination with SRK-ZS-W.

Comfort

By the application of the Twin Rotary compressor*, the outdoor units have low noise levels. Silent operation is installed in all outdoor units.

* except 30/41ZS-W

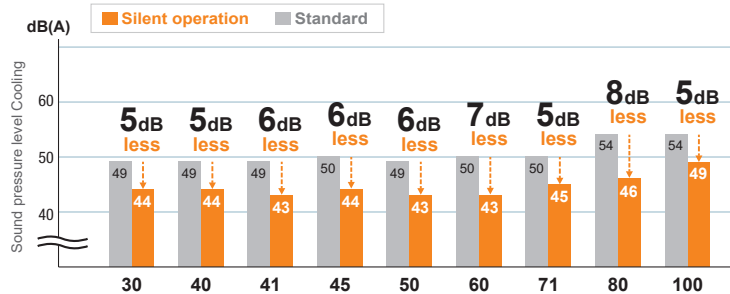

Wide Range of Operation

Our new advanced technology has expanded the heating and cooling operation range. Expand the cooling range of all model to 46°C.

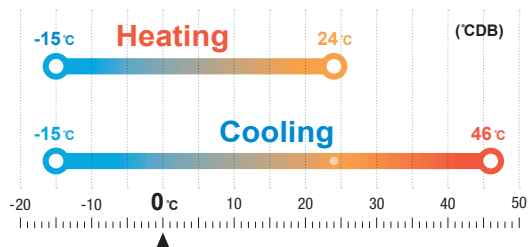

Installation Flexibility

You can freely choose where to place the indoor units to make the most of your interior space and enhance convenience.

	SCM30ZS-W	SCM40/45ZS-W	SCM41/50/60ZS-W	SCM71/80ZS-W	SCM100ZS-W
length for one indoor unit	under 25m	under 25m	under 25m	under 25m	under 25m
total length for all rooms	under 30m	under 30m	under 40m	under 70m	under 75m
height difference	Outdoor unit is higher	under 15m	under 15m	under 20m	under 20m
	Outdoor unit is lower	under 15m	under 15m	under 20m	under 20m
	Max height difference between indoor units	under 25m	under 25m	under 25m	under 25m
length of chargeless refrigerant pipe	30m	20m	40m	30m	40m

SPECIFICATIONS

Item	Model	For two rooms			For three rooms		
		SCM30ZS-W	SCM40ZS-W	SCM45ZS-W	SCM41ZS-W	SCM50ZS-W	SCM60ZS-W
Power Source		1Phase, 220 - 240V, 50Hz					
Nominal cooling capacity (Min-Max)	kW	3.0 (1.4 - 5.0)	4.0 (1.5 - 5.9)	4.5 (1.5 - 6.4)	4.0 (1.4 - 6.3)	5.0 (1.7 - 7.1)	6.0 (1.7 - 7.5)
Nominal heating capacity (Min-Max)	kW	4.0 (1.0 - 5.7)	4.5 (1.0 - 6.3)	5.3 (1.0 - 6.5)	4.5 (1.0 - 6.9)	6.0 (1.0 - 7.5)	6.8 (1.0 - 7.8)
Power Consumption	Cooling	kW	0.52 (0.32 - 1.60)	0.80 (0.34 - 2.10)	0.96 (0.34 - 2.30)	0.72 (0.32 - 1.65)	1.02 (0.43 - 2.15)
	Heating		0.74 (0.25 - 1.49)	0.83 (0.25 - 1.48)	1.06 (0.25 - 1.48)	0.81 (0.25 - 1.58)	1.16 (0.32 - 2.50)
EER	Cooling		5.77	5.00	4.69	5.56	4.90
COP	Heating		5.41	5.42	5.00	5.56	5.17
Max. running current	A		14	14	14	15	15
Sound power level	Cooling	dB(A)	62	62	63	62	62
	Heating		64	64	65	64	64
Sound pressure level	Cooling	dB(A)	49	49	50	49	49
	Heating		51	51	52	52	52
Air flow	Cooling	m ³ /min	32.5	32.5	32.5	41.0	41.0
	Heating		32.5	32.5	32.5	41.0	41.0
Exterior dimensions (Height x Width x Depth)	mm	595 x 780(+90) x 290			640 x 850(+65) x 290		
Net weight	kg	35.5	40.0		42.5	48.5	
Refrigerant	Type/GWP	R32 / 675					
	Charge	kg/TCO ₂ Eq	1.25 / 0.843	1.4 / 0.945		1.6 / 1.08	1.8 / 1.215
Refrigerant piping size	Liquid	ø mm	6.35(1/4") x 2			6.35(1/4") x 3	
	Gas		9.52(3/8") x 2			9.52(3/8") x 3	
Outdoor operating temperature range	Cooling	°CDB	-15 to 46				
	Heating		-15 to 24				
Number of Connectable indoor units		2	2	2	Min.2-Max.3	Min.2-Max.3	Min.2-Max.3
Total indoor units capacity	kW	3.0-5.0	4.0-6.0	4.5-7.0	4.0-7.0	5.0-8.5	6.0-11.0

Item	Model	For four rooms		For five rooms
		SCM71ZS-W	SCM80ZS-W	SCM100ZS-W
Power Source		1Phase, 220 - 240V, 50Hz		
Nominal cooling capacity (Min-Max)	kW	7.1 (1.8 - 8.8)	8.0 (1.8 - 9.2)	10.0 (1.7 - 11.5)
Nominal heating capacity (Min-Max)	kW	8.6 (1.1 - 9.4)	9.3 (1.1 - 9.8)	10.5 (0.9 - 11.5)
Power Consumption	Cooling	kW	1.42 (0.48 - 2.75)	1.70 (0.48 - 2.83)
	Heating		1.75 (0.35 - 3.00)	1.95 (0.35 - 3.12)
EER	Cooling		5.00	4.71
COP	Heating		4.91	4.77
Max. running current	A		20	21
Sound power level	Cooling	dB(A)	63	66
	Heating		67	67
Sound pressure level	Cooling	dB(A)	50	54
	Heating		54	54
Air flow	Cooling	m ³ /min	50.0	56.0
	Heating		56.0	56.0
Exterior dimensions (Height x Width x Depth)	mm	750 x 880(+73) x 340		945 x 970(+73) x 370
Net weight	kg	61.0		73.0
Refrigerant	Type/GWP	R32 / 675		
	Charge	kg/TCO ₂ Eq	2.55 / 1.721	2.98 / 2.012
Refrigerant piping size	Liquid	ø mm	6.35(1/4") x 4	
	Gas		9.52(3/8") x 4	
Outdoor operating temperature range	Cooling	°CDB	-15 to 46	
	Heating		-15 to 24	
Number of Connectable indoor units		Min.2-Max.4	Min.2-Max.4	Min.2* -Max.5*
Total indoor units capacity	kW	7.0-12.5	8.0-13.5	9.0-16.0*

* The data are measured under the following conditions(ISO-T1, H1). Cooling: Indoor temp. of 27°CDB, 19°CWB, and outdoor temp. of 35°CDB. Heating: Indoor temp. of 20°CDB, and outdoor temp. of 7°CDB, 6°CWB.

* Sound level Indicates the value in an anechoic chamber. During operation these values are somewhat higher due to ambient conditions.

* 'tonne(s) of CO₂ equivalent' means a quantity of greenhouse gases- expressed as the product of the weight of the greenhouse gases in metric tonnes and of their global warming potential.

* Only the following combinations are possible. The total connecting capacity of indoor units should be between 90 - 160.

[2 indoor units can be connectable]

- Includes 1 or more SRK-ZR
- SRK-ZSX x 2
- SRK-ZSX + FDE50
- SRK-ZSX + SRF35,50
- FDE50 + SRF50

[5 indoor unit can be connectable]

Only the following A and B combinations are possible.

A. The total number of (SRK-ZSX, SRF 35,50, FDE 50) is 4 or less.

5 units can be connected by connecting other indoor units.

Example: ZSX x 4 + ZS x 1 are possible.

B. When connecting 146 - 160, the following combinations are not applicable.

Indoor unit combination: Total 151(20+20+20+20+71), Total 160(20+20+20+20+80),

Total 156 (20+20+20+25+71), Total 160 (20+20+20+50+50).

[3 or 4 indoor unit can be connectable]

- No limitation



MULTI-SPLIT SYSTEM

Outdoor Units

Powerful, efficient and silent outdoor units are available in 8 sizes and able to combine up to 6 indoor units.

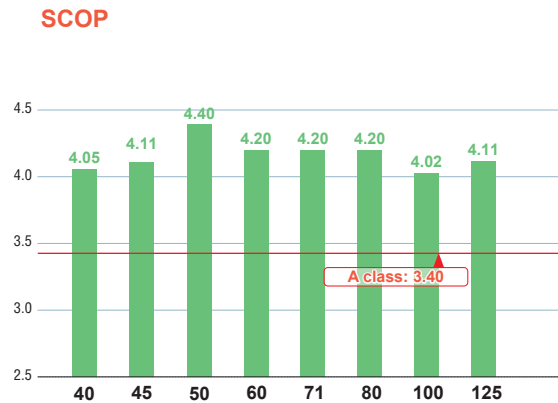
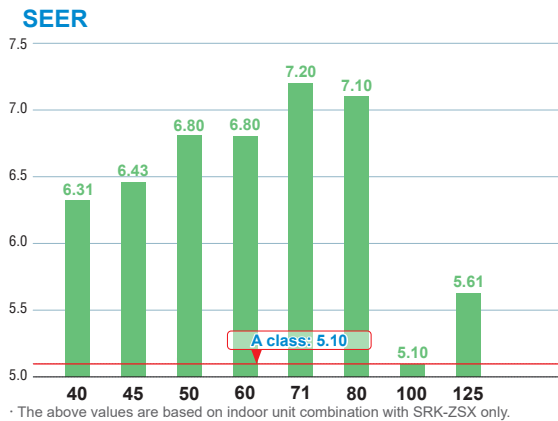

Comfort

By the application of the Twin Rotary compressor, the outdoor units have low noise levels.
 All the units also operate in heating and cooling mode with an outdoor temperature limit of -15°C.
 Silent operation is in SCM50, 60, 71, 80 type.

Installation Flexibility

With a generous maximum piping length of 90m*, you are given greater freedom to decide where the indoor units will be installed to optimise interior space and convenience.

	SCM40/45ZS-S	SCM50ZS-S1/SCM60ZM-S1	SCM71/80ZM-S1	SCM100/125ZM-S
length for one indoor unit	under 25m	under 25m	under 25m	under 25m
total length for all rooms	under 30m	under 40m	under 70m	under 90m*
height difference	Outdoor unit is higher	under 15m	under 20m	under 20m
	Outdoor unit is lower	under 15m	under 20m	under 20m
	Max height difference between indoor units	under 25m	under 25m	under 25m
length of chargeless refrigerant pipe	30m	40m	40m	50m

SPECIFICATIONS

Item	Model	For two rooms		For three rooms	
		SCM40ZS-S	SCM45ZS-S	SCM50ZS-S1	SCM60ZM-S1
Power Source		1Phase, 220 - 240V, 50Hz			
Nominal cooling capacity (Min-Max)	kW	4.0 (1.5 - 5.9)	4.5 (1.5 - 6.4)	5.0 (1.8 - 7.1)	6.0 (1.8 - 7.5)
Nominal heating capacity (Min-Max)	kW	4.5 (1.3 - 6.3)	5.3 (1.3 - 6.5)	6.0 (1.4 - 7.5)	6.8 (1.5 - 7.8)
Power Consumption	Cooling	0.84 (0.59 - 2.13)	1.04 (0.59 - 2.30)	1.05 (0.60 - 2.15)	1.43 (0.50 - 2.39)
	Heating	0.90 (0.54 - 1.70)	1.15 (0.54 - 1.92)	1.21 (0.55 - 2.58)	1.45 (0.60 - 3.00)
EER	Cooling	4.76	4.33	4.76	4.20
COP	Heating	5.00	4.61	4.96	4.69
Max. running current	A	14	14	14	17
Sound power level	Cooling	62	62	61	63
	Heating	64	64	63	65
Sound pressure level	Cooling	48	49	48	50
	Heating	50	51	50	52
Air flow	Cooling	32.5	32.5	41.0	42.0
	Heating	32.5	32.5	41.0	42.0
Exterior dimensions (Height x Width x Depth)	mm	595 x 780(+90) x 290		640 x 850(+65) x 290	
Net weight	kg	42.0		49.0	49.5
Refrigerant	Type/GWP	R410A / 2088			
	Charge	1.9 / 3.967		2.5 / 5.22	
Refrigerant piping size	Liquid	6.35(1/4") x2		6.35(1/4") x3	
	Gas	9.52(3/8") x2		9.52(3/8") x3	
Outdoor operating temperature range	Cooling	-15 to 43			
	Heating	-15 to 24			
Number of Connectable indoor units		2	2	Min.2-Max.3	Min.2-Max.3
Total indoor units capacity	kW	6.0	7.0	8.5	11.0

Item	Model	For four rooms		For five/six rooms	
		SCM71ZM-S1	SCM80ZM-S1	SCM100ZM-S	SCM125ZM-S
Power Source		1Phase, 220 - 240V, 50Hz			
Nominal cooling capacity (Min-Max)	kW	7.1 (1.8 - 8.8)	8.0 (1.8 - 9.2)	10.0 (1.8 - 12.0)	12.5 (1.8 - 14.0)
Nominal heating capacity (Min-Max)	kW	8.6 (1.5 - 9.4)	9.3 (1.5 - 9.8)	12.0 (1.5 - 13.5)	13.5 (1.5 - 14.0)
Power Consumption	Cooling	1.58 (0.48 - 2.75)	1.95 (0.48 - 2.83)	2.86 (0.65 - 4.03)	3.90 (0.65 - 4.80)
	Heating	2.00 (0.60 - 3.35)	2.26 (0.60 - 3.43)	2.93 (0.70 - 3.40)	3.25 (0.70 - 3.42)
EER	Cooling	4.49	4.10	3.50	3.21
COP	Heating	4.30	4.12	4.10	4.15
Max. running current	A	20	20	29	29
Sound power level	Cooling	63	66	68	69
	Heating	66	66	71	72
Sound pressure level	Cooling	50	54	56	57
	Heating	54	54	59	60
Air flow	Cooling	50.0	56.0	75.0	75.0
	Heating	56.0	56.0	75.0	82.0
Exterior dimensions (Height x Width x Depth)	mm	750 x 880(+73) x 340		945 x 970(+73) x 370	
Net weight	kg	62.0		92.0	
Refrigerant	Type/GWP	R410A / 2088			
	Charge	3.15 / 6.577		6.0 / 12.528	
Refrigerant piping size	Liquid	6.35(1/4") x4		6.35(1/4") x5	6.35(1/4") x6
	Gas	9.52(3/8") x4		9.52(3/8") x5	9.52(3/8") x6
Outdoor operating temperature range	Cooling	-15 to 43			
	Heating	-15 to 24			
Number of Connectable indoor units		Min.2-Max.4	Min.2-Max.4	Min.4*-Max.5	Min.4*-Max.6
Total indoor units capacity	kW	12.5	13.5	16.0	19.5

- The data are measured under the following conditions(ISO-T1, H1). Cooling: Indoor temp. of 27°CDB, 19°CWB, and outdoor temp. of 35°CDB. Heating: Indoor temp. of 20°CDB, and outdoor temp. of 7°CDB, 6°CWB.
- Sound level Indicates the value in an anechoic chamber. During operation these values are somewhat higher due to ambient conditions.
- 'tonne(s) of CO₂ equivalent' means a quantity of greenhouse gases- expressed as the product of the weight of the greenhouse gases in metric tonnes and of their global warming potential.

* In case of SRK71ZR+SRK71ZR, 2 Indoor units can be connectable. In case of the combination with SRK-ZSX, SRK71ZR & FDE50VH, only 3 indoor units can be connectable. The total connecting capacity of indoor units should be between 100 -160. (SCM100ZM-S, SCM125ZM-S)



MULTI-SPLIT SYSTEM

INDOOR UNITS SPECIFICATION FOR MULTI COMBINATIONS

Diamond Series Wall Mounted

SRK-ZSX



Item	Model	SRK20ZSX-WF*, -W	SRK25ZSX-WF*, -W	SRK35ZSX-WF*, -W	SRK50ZSX-WF*, -W	SRK60ZSX-WF*, -W
Nominal cooling capacity	kW	2.0	2.5	3.5	5.0	6.0
Nominal heating capacity	kW	3.0	3.4	4.5	5.8	6.8
Sound power level	Cooling	53	55	58	59	62
	Heating	55	56	58	62	63
Sound pressure level	Cooling(Hi/Me/Lo/Ulo)	38 / 31 / 24 / 19	39 / 33 / 25 / 19	43 / 35 / 26 / 19	44 / 39 / 31 / 22	48 / 41 / 33 / 22
	Heating(Hi/Me/Lo/Ulo)	38 / 33 / 25 / 19	40 / 34 / 27 / 19	42 / 35 / 28 / 19	47 / 41 / 33 / 23	47 / 42 / 34 / 23
Air flow	Cooling(Hi/Me/Lo/Ulo)	11.3 / 9.1 / 6.0 / 5.0	12.2 / 10.0 / 6.7 / 5.0	13.1 / 10.8 / 7.3 / 5.0	14.3 / 12.4 / 7.8 / 5.4	16.3 / 13.4 / 8.9 / 5.4
	Heating(Hi/Me/Lo/Ulo)	12.2 / 10.3 / 7.2 / 5.4	12.8 / 11.0 / 7.8 / 5.4	13.9 / 11.8 / 8.6 / 5.4	17.3 / 14.3 / 9.8 / 6.2	17.8 / 13.7 / 10.9 / 6.2
Exterior dimensions (Height x Width x Depth)	mm	305 x 920 x 220				
Net weight	kg	13.0				
Refrigerant piping size	Liquid / Gas	6.35(1/4") / 9.52(3/8")			6.35(1/4") / 12.7(1/2")	
Clean filter		Allergen Clear Filter x1, Photocatalytic Washable Deodorising Filter x1				

* Colour variation available [-WFB] [-WFT]

Diamond Series Wall Mounted

SRK-ZR



Item	Model	SRK71ZR-WF, -W	SRK80ZR-WF, -W
Nominal cooling capacity	kW	7.1	8.0
Nominal heating capacity	kW	8.0	9.0
Sound power level	Cooling	57	60
	Heating	60	62
Sound pressure level	Cooling(Hi/Me/Lo/Ulo)	44 / 41 / 37 / 25	47 / 44 / 39 / 26
	Heating(Hi/Me/Lo/Ulo)	46 / 39 / 35 / 28	47 / 41 / 36 / 29
Air flow	Cooling(Hi/Me/Lo/Ulo)	20.5 / 18.6 / 16.2 / 10.4	23.5 / 20.2 / 17.5 / 10.4
	Heating(Hi/Me/Lo/Ulo)	25.0 / 19.8 / 17.3 / 13.3	26.5 / 21.3 / 18.4 / 13.5
Exterior dimensions (Height x Width x Depth)	mm	339 x 1197 x 262	
Net weight	kg	15.5	16.5
Refrigerant piping size	Liquid / Gas	6.35 (1/4") / 15.88 (5/8")	
Clean filter		Allergen Clear Filter x1, Photocatalytic Washable Deodorising Filter x1	

* Colour variation available [-WFB] [-WFT]

Premium Series Wall Mounted

SRK-ZS



Item	Model	SRK15ZS-WF*	SRK20ZS-WF*, -W	SRK25ZS-WF*, -W	SRK35ZS-WF*, -W	SRK50ZS-WF*, -W
Nominal cooling capacity	kW	1.5	2.0	2.5	3.5	5.0
Nominal heating capacity	kW	2.0	3.0	3.4	4.5	5.8
Sound power level	Cooling	48	48	50	54	59
	Heating	50	50	53	56	60
Sound pressure level	Cooling(Hi/Me/Lo/Ulo)	34 / 25 / 22 / 19	34 / 25 / 22 / 19	36 / 28 / 23 / 19	40 / 30 / 26 / 19	46 / 36 / 29 / 22
	Heating(Hi/Me/Lo/Ulo)	36 / 29 / 23 / 19	36 / 29 / 23 / 19	39 / 30 / 24 / 19	41 / 36 / 25 / 19	46 / 37 / 31 / 24
Air flow	Cooling(Hi/Me/Lo/Ulo)	9.3 / 7.0 / 5.9 / 5.0	9.3 / 7.0 / 5.9 / 5.0	9.9 / 8.0 / 5.9 / 5.0	11.3 / 8.7 / 7.0 / 5.0	12.1 / 9.9 / 7.4 / 5.9
	Heating(Hi/Me/Lo/Ulo)	10.0 / 8.5 / 6.5 / 5.9	10.0 / 8.5 / 6.5 / 5.9	11.3 / 8.7 / 6.7 / 5.9	12.3 / 11.0 / 7.0 / 5.6	13.9 / 11.2 / 9.1 / 7.4
Exterior dimensions (Height x Width x Depth)	mm	290 x 870 x 230				
Net weight	kg	9.5				
Refrigerant piping size	Liquid / Gas	6.35(1/4") / 9.52(3/8")			6.35(1/4") / 12.7(1/2")	
Clean filter		Allergen Clear Filter x1, Photocatalytic Washable Deodorising Filter x1				

* Colour variation available [-WFB] [-WFT]

Standard Series Wall Mounted

SKM-ZSP



Item	Model	SKM15ZSP-W	SKM20ZSP-W	SKM25ZSP-W	SKM35ZSP-W
Nominal cooling capacity	kW	1.5	2.0	2.5	3.5
Nominal heating capacity	kW	2.0	3.0	3.4	4.5
Sound power level	Cooling	57	57	57	58
	Heating	56	56	56	58
Sound pressure level	Cooling(Hi/Me/Lo/Ulo)	42 / 35 / 22	42 / 35 / 22	43 / 36 / 23	44 / 37 / 25
	Heating(Hi/Me/Lo/Ulo)	41 / 36 / 26	41 / 36 / 26	41 / 36 / 27	42 / 37 / 30
Air flow	Cooling(Hi/Me/Lo/Ulo)	8.5 / 7.0 / 5.0	8.5 / 7.0 / 5.0	8.5 / 7.0 / 5.0	9.0 / 7.5 / 5.0
	Heating(Hi/Me/Lo/Ulo)	8.0 / 7.0 / 5.5	8.0 / 7.0 / 5.5	8.0 / 7.0 / 5.5	8.5 / 7.0 / 6.0
Exterior dimensions (Height x Width x Depth)	mm	267 x 783 x 210			
Net weight	kg	7.5			
Refrigerant piping size	Liquid / Gas	6.35(1/4") / 9.52(3/8")			
Clean filter		-			

NOTES

- The data are measured under the following conditions(ISO-T1, H1). Cooling: Indoor temp. of 27°CDB, 19°CWB, and outdoor temp. of 35°CDB. Heating: Indoor temp. of 20°CDB, and outdoor temp. of 7°CDB, 6°CWB.
- Sound level the value in an anechoic chamber. During operation these values are somewhat higher due to ambient conditions.

Floor Standing

SRF-ZS/ZSX



Item	Model	SRF25ZS-W	SRF35ZS-W	SRF50ZSX-W
Nominal cooling capacity	kW	2.5	3.5	5.0
Nominal heating capacity	kW	3.4	4.5	5.8
Sound power level	Cooling	50	51	58
	Heating	51	52	58
Sound pressure level	Cooling(Hi/Me/Lo/Ulo)	38 / 32 / 29 / 25	40 / 35 / 33 / 29	46 / 38 / 33 / 28
	Heating(Hi/Me/Lo/Ulo)	39 / 35 / 33 / 29	41 / 36 / 35 / 33	46 / 41 / 38 / 32
Air flow	Cooling(Hi/Me/Lo/Ulo)	9.0 / 7.6 / 6.7 / 5.8	9.2 / 7.8 / 7.3 / 6.4	11.5 / 9.6 / 7.4 / 6.6
	Heating(Hi/Me/Lo/Ulo)	10.5 / 8.2 / 7.7 / 6.6	10.7 / 8.3 / 8.1 / 7.4	12.0 / 10.0 / 9.4 / 7.6
Exterior dimensions (Height x Width x Depth)	mm	600 x 860 x 238		
Net weight	kg	18.0	19.0	
Refrigerant piping size	Liquid / Gas	6.35(1/4") / 9.52(3/8")		6.35(1/4") / 12.7(1/2")
Clean filter		Allergen Clear Filter x1, Photocatalytic Washable Deodorising Filter x1		

Ceiling Concealed

SRR-ZS

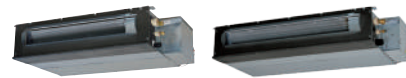

Item	Model	SRR25ZS-W	SRR35ZS-W	SRR50ZS-W	SRR60ZS-W
Nominal cooling capacity	kW	2.5	3.5	5.0	6.0
Nominal heating capacity	kW	3.4	4.5	5.8	6.8
Sound power level	Cooling	56	57	59	60
	Heating	59	60	61	63
Sound pressure level	Cooling(Hi/Me/Lo/Ulo)	37 / 33 / 30 / 24	38 / 34 / 31 / 25	41 / 37 / 34 / 29	44 / 38 / 35 / 30
	Heating(Hi/Me/Lo/Ulo)	40 / 37 / 34 / 28	42 / 38 / 35 / 29	43 / 39 / 37 / 32	45 / 41 / 38 / 33
Air flow	Cooling(Hi/Me/Lo/Ulo)	9.5 / 8.0 / 6.5 / 4.5	10.0 / 8.5 / 7.0 / 5.0	13.5 / 11.0 / 10.0 / 7.5	14.5 / 11.5 / 10.5 / 8.0
	Heating(Hi/Me/Lo/Ulo)	10.0 / 9.0 / 8.0 / 6.0	10.5 / 9.5 / 8.5 / 6.5	14.0 / 12.5 / 11.0 / 8.5	15.0 / 13.0 / 11.5 / 9.0
External static pressure	Pa	Standard : 5*1 (Initial static pressure with air filter : 5Pa)			
Exterior dimensions (Height x Width x Depth)	mm	200 x 750 x 500		200 x 950 x 500	
Net weight	kg	20.5		24.0	
Refrigerant piping size	Liquid / Gas	6.35(1/4") / 9.52(3/8")		6.35(1/4") / 12.7(1/2")	
Bottom air inlet kit (option)		UT-BAT1EF		UT-BAT2EF	

*1 The maximum external static pressure can be used up to 35Pa(25*35ZS), 50Pa(50*60ZS), but the airflow will be reduced.

4way Ceiling Cassette(600x600mm)

FDTC-VH



Item	Model	FDTC25VH1	FDTC35VH1	FDTC50VH	FDTC60VH
Nominal cooling capacity	kW	2.5	3.5	5.0	6.0
Nominal heating capacity	kW	3.4	4.5	5.8	6.8
Sound power level	Cooling	51	52	59	60
	Heating	52	53	59	60
Sound pressure level	Cooling(Hi/Me/Lo/Ulo)	38 / 34 / 30 / 27	39 / 36 / 32 / 29	44 / 40 / 35 / 27	46 / 42 / 38 / 31
	Heating(Hi/Me/Lo/Ulo)	39 / 36 / 32 / 28	41 / 38 / 34 / 30	44 / 40 / 35 / 27	46 / 42 / 38 / 31
Air flow	Cooling(Hi/Me/Lo/Ulo)	8.5 / 7.5 / 7.0 / 6.0	9.0 / 8.0 / 7.5 / 6.5	13.0 / 11.0 / 9.0 / 7.0	14.0 / 12.0 / 10.0 / 8.0
	Heating(Hi/Me/Lo/Ulo)	9.5 / 8.5 / 7.5 / 6.5	10.0 / 9.0 / 8.0 / 7.0	13.0 / 11.0 / 9.0 / 7.0	14.0 / 12.0 / 10.0 / 8.0
Exterior dimensions (Height x Width x Depth)	mm	Unit : 248 x 570 x 570		Panel : 10 x 620 x 620	
Net weight	kg	16.0 (Unit : 13.5 Panel : 2.5)		16.5 (Unit : 14 Panel : 2.5)	
Refrigerant piping size	Liquid / Gas	6.35(1/4") / 9.52(3/8")		6.35(1/4") / 12.7(1/2")	
Panel		Standard Panel : TC-PSA-5AW-E(Honeycomb), TC-PSAG-5AW-E(Grid) Draft Prevention Panel : TC-PSAE-5AW-E(Honeycomb), TC-PSAGE-5AW-E(Grid)			

Duct Connected-Low/Middle Static Pressure / Ceiling Suspended

FDUM-VH / FDE-VH



Item	Model	FDUM50VH	FDE50VH
Nominal cooling capacity	kW	5.0	5.0
Nominal heating capacity	kW	5.8	5.8
Sound power level	Cooling	60	60
	Heating	60	60
Sound pressure level	Cooling(Hi/Me/Lo/Ulo)	37 / 32 / 29 / 26	46 / 38 / 36 / 31
	Heating(Hi/Me/Lo/Ulo)	37 / 32 / 29 / 26	46 / 38 / 36 / 31
Air flow	Cooling(Hi/Me/Lo/Ulo)	13.0 / 10.0 / 9.0 / 8.0	13.0 / 10.0 / 9.0 / 7.0
	Heating(Hi/Me/Lo/Ulo)	13.0 / 10.0 / 9.0 / 8.0	13.0 / 10.0 / 9.0 / 7.0
Available external static pressure	Pa	Standard : 35 Max : 100	-
Exterior dimensions (Height x Width x Depth)	mm	280 x 750 x 635	210 x 1070 x 690
Net weight	kg	29.0	28.0
Refrigerant piping size	Liquid / Gas	6.35(1/4") / 12.7(1/2")	
Air filter		Filter KIT : UM-FL1EF (option)	Pocket Plastic net (Washable) x2



MULTI-SPLIT SYSTEM

TABLE OF INDOOR UNIT COMBINATIONS

- The combinations of the indoor units is indicated by numbers. They are read as follows.
(Example) SRK15ZS-W → 15 SRK20ZS-W → 20 SRK25ZSX-W → 25
- The capacity of the indoor units is shown by rooms. If this exceeds the maximum capacity of the outdoor unit, the demand capacity will be proportionally distributed.
- If units are to be combined, use the table below to make the proper selection.

SCM30ZS-W Table of Indoor unit combination only with SRK-ZS, SKM-ZSP type

Indoor unit combination		Heating capacity (kW)					Power consumption(W)			Standard current(A)			
		Room heating capacity		Total capacity			Min.	Standard	Max.	220V	230V	240V	
		A	B	Min.	Standard	Max.							
Heating operation	1*1 room	15	2.0	-	1.0	2.0	3.2	250	510	940	2.4	2.3	2.2
		20	3.0	-	1.0	3.0	4.3	250	780	1260	3.7	3.6	3.4
		25	3.4	-	1.0	3.4	4.5	250	910	1310	4.4	4.2	4.0
	2*2 room	15 + 15	2.00	2.00	1.1	4.0	5.7	250	740	1490	3.5	3.4	3.2
		15 + 20	1.71	2.29	1.1	4.0	5.7	250	740	1490	3.5	3.4	3.2
		15 + 25	1.50	2.50	1.1	4.0	5.7	250	740	1490	3.5	3.4	3.2
20 + 20		2.00	2.00	1.1	4.0	5.7	250	740	1490	3.5	3.4	3.2	
20 + 25		1.78	2.22	1.1	4.0	5.7	250	740	1490	3.5	3.4	3.2	
25 + 25		2.00	2.00	1.1	4.0	5.7	250	740	1490	3.5	3.4	3.2	

The values are for 1 indoor unit (*1) and 2 indoor units (*2) operation.
The same hereinafter.

Indoor unit combination		Cooling capacity (kW)					Power consumption(W)			Standard current(A)			
		Room cooling capacity		Total capacity			Min.	Standard	Max.	220V	230V	240V	
		A	B	Min.	Standard	Max.							
Cooling operation	1 room	15	1.50	-	1.4	1.5	2.2	320	350	710	1.8	1.7	1.6
		20	2.00	-	1.4	2.0	2.9	320	510	930	2.6	2.5	2.4
		25	2.50	-	1.4	2.5	3.1	320	710	990	3.6	3.5	3.3
	2 room	15 + 15	1.50	1.50	1.6	3.0	4.4	320	520	1280	2.7	2.5	2.4
		15 + 20	1.29	1.71	1.6	3.0	4.9	320	520	1520	2.7	2.5	2.4
		15 + 25	1.13	1.88	1.6	3.0	5.0	320	520	1600	2.7	2.5	2.4
		20 + 20	1.50	1.50	1.6	3.0	5.0	320	520	1600	2.7	2.5	2.4
		20 + 25	1.33	1.67	1.6	3.0	5.0	320	520	1600	2.7	2.5	2.4
		25 + 25	1.50	1.50	1.6	3.0	5.0	320	520	1600	2.7	2.5	2.4

SCM40ZS-W Table of Indoor unit combination only with SRK-ZSX type

Indoor unit combination		Heating capacity (kW)					Power consumption(W)			Standard current(A)			
		Room heating capacity		Total capacity			Min.	Standard	Max.	220V	230V	240V	
		A	B	Min.	Standard	Max.							
Heating operation	1*1 room	20	3.00	-	1.0	3.0	4.5	250	680	1140	3.2	3.1	3.0
		25	3.40	-	1.0	3.4	4.9	250	790	1270	3.7	3.5	3.4
		35	4.50	-	1.0	4.5	5.4	250	1140	1470	5.3	5.1	4.8
	2*2 room	20 + 20	2.25	2.25	1.2	4.5	6.3	250	830	1480	3.8	3.7	3.5
		20 + 25	2.00	2.50	1.2	4.5	6.3	250	830	1480	3.8	3.7	3.5
		20 + 35	1.64	2.86	1.2	4.5	6.3	250	830	1480	3.8	3.7	3.5
2*2 room	25 + 25	2.25	2.25	1.2	4.5	6.3	250	830	1480	3.8	3.7	3.5	
	25 + 35	1.88	2.63	1.2	4.5	6.3	250	830	1480	3.8	3.7	3.5	

Indoor unit combination		Cooling capacity (kW)					Power consumption(W)			Standard current(A)			
		Room cooling capacity		Total capacity			Min.	Standard	Max.	220V	230V	240V	
		A	B	Min.	Standard	Max.							
Cooling operation	1 room	20	2.00	-	1.5	2.0	3.4	340	430	930	2.2	2.1	2.0
		25	2.50	-	1.5	2.5	3.8	340	600	1110	3.0	2.9	2.8
		35	3.50	-	1.5	3.5	4.5	340	1000	1470	4.7	4.5	4.3
	2 room	20 + 20	2.00	2.00	1.7	4.0	5.9	340	800	2100	3.7	3.5	3.4
		20 + 25	1.78	2.22	1.7	4.0	5.9	340	800	2100	3.7	3.5	3.4
		20 + 35	1.45	2.55	1.7	4.0	5.9	340	800	2100	3.7	3.5	3.4
		25 + 25	2.00	2.00	1.7	4.0	5.9	340	800	2100	3.7	3.5	3.4
		25 + 35	1.67	2.33	1.7	4.0	5.9	340	800	2100	3.7	3.5	3.4

COMBINATIONS

SCM40ZS-W Table of Indoor unit combination with other indoor unit

Indoor unit combination			Heating capacity (kW)					Power consumption(W)			Standard current(A)		
			Room heating capacity		Total capacity			Min.	Standard	Max.	220V	230V	240V
			A	B	Min.	Standard	Max.						
Heating operation	1 room	20	3.00	-	1.0	3.0	3.5	250	780	940	3.8	3.6	3.5
		25	3.40	-	1.0	3.4	4.0	250	910	1120	4.4	4.2	4.1
		35	4.50	-	1.0	4.5	4.8	250	1310	1350	6.4	6.1	5.9
	2 room	20 + 20	2.25	2.25	1.2	4.5	5.5	250	990	1270	4.8	4.6	4.4
		20 + 25	2.00	2.50	1.2	4.5	6.3	250	990	1630	4.7	4.5	4.3
		20 + 35	1.64	2.86	1.2	4.5	6.3	250	990	1630	4.6	4.4	4.2
	25 + 25	2.25	2.25	1.2	4.5	6.3	250	990	1630	4.6	4.4	4.2	
	25 + 35	1.88	2.63	1.2	4.5	6.3	250	990	1630	4.6	4.4	4.2	

Indoor unit combination			Cooling capacity (kW)					Power consumption(W)			Standard current(A)		
			Room cooling capacity		Total capacity			Min.	Standard	Max.	220V	230V	240V
			A	B	Min.	Standard	Max.						
Cooling operation	1 room	20	2.00	-	1.5	2.0	3.1	340	510	990	2.5	2.4	2.3
		25	2.50	-	1.5	2.5	3.4	340	710	1120	3.4	3.2	3.1
		35	3.50	-	1.5	3.5	4.1	340	1190	1570	5.5	5.3	5.0
	2 room	20 + 20	2.00	2.00	1.7	4.0	5.4	340	1000	1920	4.6	4.4	4.2
		20 + 25	1.78	2.22	1.7	4.0	5.6	340	1000	2100	4.6	4.4	4.2
		20 + 35	1.45	2.55	1.7	4.0	5.6	340	1000	2100	4.6	4.4	4.2
	25 + 25	2.00	2.00	1.7	4.0	5.6	340	1000	2100	4.6	4.4	4.2	
	25 + 35	1.67	2.33	1.7	4.0	5.6	340	1000	2100	4.6	4.4	4.2	

SCM45ZS-W Table of Indoor unit combination only with SRK-ZSX type

Indoor unit combination			Heating capacity (kW)					Power consumption(W)			Standard current(A)		
			Room heating capacity		Total capacity			Min.	Standard	Max.	220V	230V	240V
			A	B	Min.	Standard	Max.						
Heating operation	1 room	20	3.00	-	1.0	3.0	4.5	250	680	1140	3.2	3.1	3.0
		25	3.40	-	1.0	3.4	4.9	250	790	1270	3.7	3.5	3.4
		35	4.50	-	1.0	4.5	5.4	250	1140	1470	5.3	5.1	4.8
	2 room	20 + 20	2.25	2.25	1.2	4.5	6.5	250	830	1480	3.8	3.7	3.5
		20 + 25	2.36	2.94	1.2	5.3	6.5	250	1060	1480	4.9	4.7	4.5
		20 + 35	1.93	3.37	1.2	5.3	6.5	250	1060	1480	4.9	4.7	4.5
	25 + 25	2.65	2.65	1.2	5.3	6.5	250	1060	1480	4.9	4.7	4.5	
	25 + 35	2.21	3.09	1.2	5.3	6.5	250	1060	1480	4.9	4.7	4.5	
	35 + 35	2.65	2.65	1.2	5.3	6.5	250	1060	1480	4.9	4.7	4.5	

Indoor unit combination			Cooling capacity (kW)					Power consumption(W)			Standard current(A)		
			Room cooling capacity		Total capacity			Min.	Standard	Max.	220V	230V	240V
			A	B	Min.	Standard	Max.						
Cooling operation	1 room	20	2.00	-	1.5	2.0	3.4	340	430	930	2.2	2.1	2.0
		25	2.50	-	1.5	2.5	3.8	340	600	1110	3.0	2.9	2.8
		35	3.50	-	1.5	3.5	4.5	340	1000	1470	4.7	4.5	4.3
	2 room	20 + 20	2.00	2.00	1.7	4.0	6.2	340	860	2100	4.0	3.8	3.7
		20 + 25	2.00	2.50	1.7	4.5	6.4	340	960	2300	4.5	4.3	4.1
		20 + 35	1.64	2.86	1.7	4.5	6.4	340	960	2300	4.5	4.3	4.1
	25 + 25	2.25	2.25	1.7	4.5	6.4	340	960	2300	4.5	4.3	4.1	
	25 + 35	1.88	2.63	1.7	4.5	6.4	340	960	2300	4.5	4.3	4.1	
	35 + 35	2.25	2.25	1.7	4.5	6.4	340	960	2300	4.5	4.3	4.1	

SCM45ZS-W Table of Indoor unit combination with other indoor unit

Indoor unit combination			Heating capacity (kW)					Power consumption(W)			Standard current(A)		
			Room heating capacity		Total capacity			Min.	Standard	Max.	220V	230V	240V
			A	B	Min.	Standard	Max.						
Heating operation	1 room	20	3.00	-	1.0	3.0	3.5	250	780	940	3.7	3.5	3.4
		25	3.40	-	1.0	3.4	4.0	250	910	1120	4.3	4.1	3.9
		35	4.50	-	1.0	4.5	4.8	250	1310	1350	6.1	5.8	5.6
	2 room	20 + 20	2.25	2.25	1.2	4.5	5.5	250	990	1270	4.6	4.4	4.2
		20 + 25	2.36	2.94	1.2	5.3	6.5	250	1280	1630	5.9	5.7	5.4
		20 + 35	1.93	3.37	1.2	5.3	6.5	250	1280	1630	5.9	5.7	5.4
	25 + 25	2.65	2.65	1.2	5.3	6.5	250	1280	1630	5.9	5.7	5.4	
	25 + 35	2.21	3.09	1.2	5.3	6.5	250	1280	1630	5.9	5.7	5.4	
	35 + 35	2.65	2.65	1.2	5.3	6.5	250	1280	1630	5.9	5.7	5.4	

Indoor unit combination			Cooling capacity (kW)					Power consumption(W)			Standard current(A)		
			Room cooling capacity		Total capacity			Min.	Standard	Max.	220V	230V	240V
			A	B	Min.	Standard	Max.						
Cooling operation	1 room	20	2.00	-	1.5	2.0	3.1	340	510	990	2.5	2.4	2.3
		25	2.50	-	1.5	2.5	3.4	340	710	1120	3.4	3.2	3.1
		35	3.50	-	1.5	3.5	4.1	340	1190	1570	5.5	5.3	5.0
	2 room	20 + 20	2.00	2.00	1.7	4.0	5.4	340	1050	1920	4.8	4.6	4.4
		20 + 25	2.00	2.50	1.7	4.5	5.6	340	1200	2300	5.5	5.3	5.1
		20 + 35	1.64	2.86	1.7	4.5	5.6	340	1200	2300	5.5	5.3	5.1
	25 + 25	2.25	2.25	1.7	4.5	5.6	340	1200	2300	5.5	5.3	5.1	
	25 + 35	1.88	2.63	1.7	4.5	5.6	340	1200	2300	5.5	5.3	5.1	
	35 + 35	2.25	2.25	1.7	4.5	5.6	340	1200	2300	5.5	5.3	5.1	



MULTI-SPLIT SYSTEM

SCM41ZS-W Table of Indoor unit combination only with SRK-ZS, SKM-ZSP type

Indoor unit combination		Heating capacity (kW)						Power consumption(W)			Standard current(A)			
		Room heating capacity			Total capacity			Min.	Standard	Max.	220V	230V	240V	
		A	B	C	Min.	Standard	Max.							
Heating operation	1 room	15	2.00	-	-	1.0	2.0	3.2	250	550	990	2.6	2.5	2.4
		20	3.00	-	-	1.0	3.0	4.3	250	870	1330	4.1	3.9	3.8
		25	3.40	-	-	1.0	3.4	4.5	250	1010	1390	4.8	4.6	4.4
		35	4.50	-	-	1.0	4.5	5.0	250	1390	1550	6.6	6.3	6.0
	2 room	15 + 15	1.70	1.70	-	1.1	3.4	6.6	250	700	1580	3.3	3.2	3.0
		15 + 20	1.67	2.23	-	1.1	3.9	6.6	250	840	1580	4.0	3.8	3.6
		15 + 25	1.69	2.81	-	1.1	4.5	6.6	250	1020	1580	4.8	4.6	4.4
		15 + 35	1.35	3.15	-	1.1	4.5	6.6	250	1020	1580	4.8	4.6	4.4
		20 + 20	2.25	2.25	-	1.1	4.5	6.6	250	1020	1580	4.8	4.6	4.4
		20 + 25	2.00	2.50	-	1.1	4.5	6.6	250	1020	1580	4.8	4.6	4.4
		20 + 35	1.64	2.86	-	1.1	4.5	6.6	250	1020	1580	4.8	4.6	4.4
		25 + 25	2.25	2.25	-	1.1	4.5	6.6	250	1020	1580	4.8	4.6	4.4
3 room	35 + 35	2.25	2.25	-	1.1	4.5	6.6	250	1020	1580	4.8	4.6	4.4	
	15 + 15 + 15	1.50	1.50	1.50	1.2	4.5	6.9	250	810	1580	3.8	3.7	3.5	
	15 + 15 + 20	1.35	1.35	1.80	1.2	4.5	6.9	250	810	1580	3.8	3.7	3.5	
	15 + 15 + 25	1.23	1.23	2.05	1.2	4.5	6.9	250	810	1580	3.8	3.7	3.5	
	15 + 15 + 35	1.04	1.04	2.42	1.2	4.5	6.9	250	810	1580	3.8	3.7	3.5	
	15 + 20 + 20	1.23	1.64	1.64	1.2	4.5	6.9	250	810	1580	3.8	3.7	3.5	
	15 + 20 + 25	1.13	1.50	1.88	1.2	4.5	6.9	250	810	1580	3.8	3.7	3.5	
	15 + 20 + 35	0.96	1.29	2.25	1.2	4.5	6.9	250	810	1580	3.8	3.7	3.5	
	15 + 25 + 25	1.04	1.73	1.73	1.2	4.5	6.9	250	810	1580	3.8	3.7	3.5	
	20 + 20 + 20	1.50	1.50	1.50	1.2	4.5	6.9	250	810	1580	3.8	3.7	3.5	
	20 + 20 + 25	1.38	1.38	1.73	1.2	4.5	6.9	250	810	1580	3.8	3.7	3.5	
	20 + 25 + 25	1.29	1.61	1.61	1.2	4.5	6.9	250	810	1580	3.8	3.7	3.5	

Indoor unit combination		Cooling capacity (kW)						Power consumption(W)			Standard current(A)			
		Room cooling capacity			Total capacity			Min.	Standard	Max.	220V	230V	240V	
		A	B	C	Min.	Standard	Max.							
Cooling operation	1 room	15	1.50	-	-	1.4	1.5	2.2	320	360	740	1.7	1.6	1.6
		20	2.00	-	-	1.4	2.0	2.9	320	530	970	2.5	2.4	2.3
		25	2.50	-	-	1.4	2.5	3.1	320	730	1040	3.5	3.3	3.2
		35	3.50	-	-	1.4	3.5	4.0	320	1120	1330	5.4	5.1	4.9
	2 room	15 + 15	1.50	1.50	-	1.5	3.0	4.9	320	550	1400	2.6	2.5	2.4
		15 + 20	1.50	2.00	-	1.5	3.5	5.5	320	700	1600	3.3	3.2	3.1
		15 + 25	1.50	2.50	-	1.5	4.0	5.7	320	910	1650	4.4	4.2	4.0
		15 + 35	1.20	2.80	-	1.5	4.0	5.7	320	910	1650	4.4	4.2	4.0
		20 + 20	2.00	2.00	-	1.5	4.0	5.7	320	910	1650	4.4	4.2	4.0
		20 + 25	1.78	2.22	-	1.5	4.0	5.7	320	910	1650	4.4	4.2	4.0
		20 + 35	1.45	2.55	-	1.5	4.0	5.7	320	910	1650	4.4	4.2	4.0
		25 + 25	2.00	2.00	-	1.5	4.0	5.7	320	910	1650	4.4	4.2	4.0
	3 room	25 + 35	1.67	2.33	-	1.5	4.0	5.7	320	910	1650	4.4	4.2	4.0
		35 + 35	2.00	2.00	-	1.5	4.0	5.7	320	910	1650	4.4	4.2	4.0
		15 + 15 + 15	1.33	1.33	1.33	1.6	4.0	6.3	320	720	1650	3.4	3.3	3.2
		15 + 15 + 20	1.20	1.20	1.60	1.6	4.0	6.3	320	720	1650	3.4	3.3	3.2
		15 + 15 + 25	1.09	1.09	1.82	1.6	4.0	6.3	320	720	1650	3.4	3.3	3.2
		15 + 15 + 35	0.92	0.92	2.15	1.6	4.0	6.3	320	720	1650	3.4	3.3	3.2
		15 + 20 + 20	1.09	1.45	1.45	1.6	4.0	6.3	320	720	1650	3.4	3.3	3.2
		15 + 20 + 25	1.00	1.33	1.67	1.6	4.0	6.3	320	720	1650	3.4	3.3	3.2
		15 + 20 + 35	0.86	1.14	2.00	1.6	4.0	6.3	320	720	1650	3.4	3.3	3.2
		15 + 25 + 25	0.92	1.54	1.54	1.6	4.0	6.3	320	720	1650	3.4	3.3	3.2
		20 + 20 + 20	1.33	1.33	1.33	1.6	4.0	6.3	320	720	1650	3.4	3.3	3.2
		20 + 20 + 25	1.23	1.23	1.54	1.6	4.0	6.3	320	720	1650	3.4	3.3	3.2
20 + 25 + 25	1.14	1.43	1.43	1.6	4.0	6.3	320	720	1650	3.4	3.3	3.2		

SCM50ZS-W Table of Indoor unit combination only with SRK-ZSX type

Indoor unit combination		Heating capacity (kW)						Power consumption(W)			Standard current(A)			
		Room heating capacity			Total capacity			Min.	Standard	Max.	220V	230V	240V	
		A	B	C	Min.	Standard	Max.							
Heating operation	1 room	20	3.00	-	-	1.0	3.0	3.7	320	780	1100	3.6	3.5	3.3
		25	3.40	-	-	1.0	3.4	4.2	320	950	1240	4.4	4.2	4.0
		35	4.50	-	-	1.0	4.5	5.0	320	1270	1490	5.9	5.6	5.4
		50	5.80	-	-	1.0	5.8	6.5	320	1710	2310	7.9	7.6	7.3
	2 room	20 + 20	2.70	2.70	-	1.2	5.4	7.3	290	1050	2500	4.9	4.7	4.5
		20 + 25	2.62	3.28	-	1.2	5.9	7.3	290	1180	2500	5.5	5.2	5.0
		20 + 35	2.18	3.82	-	1.2	6.0	7.3	290	1200	2500	5.6	5.3	5.1
		20 + 50	1.71	4.29	-	1.2	6.0	7.3	290	1200	2500	5.6	5.3	5.1
		25 + 25	3.00	3.00	-	1.2	6.0	7.3	290	1200	2500	5.6	5.3	5.1
		25 + 35	2.50	3.50	-	1.2	6.0	7.3	290	1200	2500	5.6	5.3	5.1
		25 + 50	2.00	4.00	-	1.2	6.0	7.3	290	1200	2500	5.6	5.3	5.1
		35 + 35	3.00	3.00	-	1.2	6.0	7.3	290	1200	2500	5.6	5.3	5.1
	3 room	35 + 50	2.47	3.53	-	1.2	6.0	7.3	290	1200	2500	5.6	5.3	5.1
		20 + 20 + 20	2.00	2.00	2.00	1.4	6.0	7.5	270	1160	2500	5.4	5.1	4.9
		20 + 20 + 25	1.85	1.85	2.31	1.4	6.0	7.5	270	1160	2500	5.4	5.1	4.9
		20 + 20 + 35	1.60	1.60	2.80	1.4	6.0	7.5	270	1160	2500	5.4	5.1	4.9
		20 + 25 + 25	1.71	2.14	2.14	1.4	6.0	7.5	270	1160	2500	5.4	5.1	4.9
		20 + 25 + 35	1.50	1.88	2.63	1.4	6.0	7.5	270	1160	2500	5.4	5.1	4.9
		25 + 25 + 25	2.00	2.00	2.00	1.4	6.0	7.5	270	1160	2500	5.4	5.1	4.9
		25 + 25 + 35	1.76	1.76	2.47	1.4	6.0	7.5	270	1160	2500	5.4	5.1	4.9

COMBINATIONS

Indoor unit combination		Cooling capacity (kW)						Power consumption(W)			Standard current(A)			
		Room cooling capacity			Total capacity			Min.	Standard	Max.	220V	230V	240V	
		A	B	C	Min.	Standard	Max.							
Cooling operation	1 room	20	2.00	-	-	1.7	2.0	2.8	430	500	950	2.4	2.3	2.2
		25	2.50	-	-	1.7	2.5	3.4	430	680	1070	3.2	3.1	3.0
		35	3.50	-	-	1.7	3.5	3.9	430	1010	1230	4.7	4.5	4.3
		50	5.00	-	-	1.7	5.0	5.5	430	1530	2000	7.0	6.7	6.4
	2 room	20 + 20	2.00	2.00	-	1.8	4.0	5.7	390	750	1750	3.5	3.3	3.2
		20 + 25	2.00	2.50	-	1.8	4.5	5.9	390	990	1910	4.6	4.4	4.2
		20 + 35	1.82	3.18	-	1.8	5.0	6.5	390	1110	2150	5.1	4.9	4.7
		20 + 50	1.43	3.57	-	1.8	5.0	6.5	390	1110	2150	5.1	4.9	4.7
		25 + 25	2.50	2.50	-	1.8	5.0	6.5	390	1110	2150	5.1	4.9	4.7
		25 + 35	2.08	2.92	-	1.8	5.0	6.5	390	1110	2150	5.1	4.9	4.7
		25 + 50	1.67	3.33	-	1.8	5.0	6.5	390	1110	2150	5.1	4.9	4.7
		35 + 35	2.50	2.50	-	1.8	5.0	6.5	390	1110	2150	5.1	4.9	4.7
	3 room	35 + 50	2.06	2.94	-	1.8	5.0	6.5	390	1110	2150	5.1	4.9	4.7
		20 + 20 + 20	1.67	1.67	1.67	2.1	5.0	7.1	350	1020	2150	4.7	4.5	4.3
		20 + 20 + 25	1.54	1.54	1.92	2.1	5.0	7.1	350	1020	2150	4.7	4.5	4.3
		20 + 20 + 35	1.33	1.33	2.33	2.1	5.0	7.1	350	1020	2150	4.7	4.5	4.3
		20 + 25 + 25	1.43	1.79	1.79	2.1	5.0	7.1	350	1020	2150	4.7	4.5	4.3
		20 + 25 + 35	1.25	1.56	2.19	2.1	5.0	7.1	350	1020	2150	4.7	4.5	4.3
		25 + 25 + 25	1.67	1.67	1.67	2.1	5.0	7.1	350	1020	2150	4.7	4.5	4.3
		25 + 25 + 35	1.47	1.47	2.06	2.1	5.0	7.1	350	1020	2150	4.7	4.5	4.3

SCM50ZS-W Table of Indoor unit combination with other indoor unit

Indoor unit combination		Heating capacity (kW)						Power consumption(W)			Standard current(A)			
		Room heating capacity			Total capacity			Min.	Standard	Max.	220V	230V	240V	
		A	B	C	Min.	Standard	Max.							
Heating operation	1 room	20	3.00	-	-	1.0	3.0	3.5	320	970	1100	4.5	4.3	4.1
		25	3.40	-	-	1.0	3.4	4.0	320	1140	1240	5.3	5.1	4.8
		35	4.50	-	-	1.0	4.5	4.8	320	1480	1490	6.9	6.6	6.3
		50	5.80	-	-	1.0	5.8	6.1	320	1780	2310	8.3	7.9	7.6
	2 room	20 + 20	2.70	2.70	-	1.2	5.4	7.0	290	1350	2500	6.3	6.0	5.7
		20 + 25	2.62	3.28	-	1.2	5.9	7.0	290	1480	2500	6.9	6.6	6.3
		20 + 35	2.18	3.82	-	1.2	6.0	7.0	290	1500	2500	7.0	6.7	6.4
		20 + 50	1.71	4.29	-	1.2	6.0	7.0	290	1500	2500	7.0	6.7	6.4
		25 + 25	3.00	3.00	-	1.2	6.0	7.0	290	1500	2500	7.0	6.7	6.4
		25 + 35	2.50	3.50	-	1.2	6.0	7.0	290	1500	2500	7.0	6.7	6.4
		25 + 50	2.00	4.00	-	1.2	6.0	7.0	290	1500	2500	7.0	6.7	6.4
		35 + 35	3.00	3.00	-	1.2	6.0	7.0	290	1500	2500	7.0	6.7	6.4
	3 room	35 + 50	2.47	3.53	-	1.2	6.0	7.0	290	1500	2500	7.0	6.7	6.4
		20 + 20 + 20	2.00	2.00	2.00	1.4	6.0	7.3	270	1300	2500	6.0	5.8	5.5
		20 + 20 + 25	1.85	1.85	2.31	1.4	6.0	7.3	270	1300	2500	6.0	5.8	5.5
		20 + 20 + 35	1.60	1.60	2.80	1.4	6.0	7.3	270	1300	2500	6.0	5.8	5.5
		20 + 25 + 25	1.71	2.14	2.14	1.4	6.0	7.3	270	1300	2500	6.0	5.8	5.5
		20 + 25 + 35	1.50	1.88	2.63	1.4	6.0	7.3	270	1300	2500	6.0	5.8	5.5
		25 + 25 + 25	2.00	2.00	2.00	1.4	6.0	7.3	270	1300	2500	6.0	5.8	5.5
		25 + 25 + 35	1.76	1.76	2.47	1.4	6.0	7.3	270	1300	2500	6.0	5.8	5.5

Indoor unit combination		Cooling capacity (kW)						Power consumption(W)			Standard current(A)			
		Room cooling capacity			Total capacity			Min.	Standard	Max.	220V	230V	240V	
		A	B	C	Min.	Standard	Max.							
Cooling operation	1 room	20	2.00	-	-	1.7	2.0	2.7	430	530	900	2.5	2.4	2.3
		25	2.50	-	-	1.7	2.5	3.2	430	730	1070	3.4	3.3	3.1
		35	3.50	-	-	1.7	3.5	3.7	430	1120	1230	5.2	4.9	4.7
		50	5.00	-	-	1.7	5.0	5.3	430	1710	2000	7.9	7.5	7.2
	2 room	20 + 20	2.00	2.00	-	1.8	4.0	5.6	390	950	1800	4.4	4.2	4.0
		20 + 25	2.00	2.50	-	1.8	4.5	5.8	390	1110	1980	5.1	4.9	4.7
		20 + 35	1.82	3.18	-	1.8	5.0	6.3	390	1350	2150	6.2	5.9	5.7
		20 + 50	1.43	3.57	-	1.8	5.0	6.3	390	1350	2150	6.2	5.9	5.7
		25 + 25	2.50	2.50	-	1.8	5.0	6.3	390	1350	2150	6.2	5.9	5.7
		25 + 35	2.08	2.92	-	1.8	5.0	6.3	390	1350	2150	6.2	5.9	5.7
		25 + 50	1.67	3.33	-	1.8	5.0	6.3	390	1350	2150	6.2	5.9	5.7
		35 + 35	2.50	2.50	-	1.8	5.0	6.3	390	1350	2150	6.2	5.9	5.7
	3 room	35 + 50	2.06	2.94	-	1.8	5.0	6.3	390	1350	2150	6.2	5.9	5.7
		20 + 20 + 20	1.67	1.67	1.67	2.1	5.0	6.9	350	1120	2150	5.1	4.9	4.7
		20 + 20 + 25	1.54	1.54	1.92	2.1	5.0	6.9	350	1120	2150	5.1	4.9	4.7
		20 + 20 + 35	1.33	1.33	2.33	2.1	5.0	6.9	350	1120	2150	5.1	4.9	4.7
		20 + 25 + 25	1.43	1.79	1.79	2.1	5.0	6.9	350	1120	2150	5.1	4.9	4.7
		20 + 25 + 35	1.25	1.56	2.19	2.1	5.0	6.9	350	1120	2150	5.1	4.9	4.7
		25 + 25 + 25	1.67	1.67	1.67	2.1	5.0	6.9	350	1120	2150	5.1	4.9	4.7
		25 + 25 + 35	1.47	1.47	2.06	2.1	5.0	6.9	350	1120	2150	5.1	4.9	4.7



MULTI-SPLIT SYSTEM

SCM60ZS-W Table of Indoor unit combination only with SRK-ZSX type

Indoor unit combination		Heating capacity (kW)						Power consumption(W)			Standard current(A)			
		Room heating capacity			Total capacity			Min.	Standard	Max.	220V	230V	240V	
		A	B	C	Min.	Standard	Max.							
Heating operation	1 room	20	3.00	-	-	1.0	3.0	3.7	320	780	1100	3.6	3.5	3.3
		25	3.40	-	-	1.0	3.4	4.2	320	950	1240	4.4	4.2	4.0
		35	4.50	-	-	1.0	4.5	5.0	320	1270	1490	5.9	5.6	5.4
		50	5.80	-	-	1.0	5.8	6.5	320	1710	2310	7.9	7.6	7.3
		60	6.80	-	-	1.0	6.8	7.3	320	2040	2660	9.5	9.1	8.7
	2 room	20 + 20	2.70	2.70	-	1.2	5.4	7.3	290	1050	2100	4.9	4.7	4.5
		20 + 25	2.62	3.28	-	1.2	5.9	7.5	290	1180	2550	5.5	5.2	5.0
		20 + 35	2.40	4.20	-	1.2	6.6	7.6	290	1360	2800	6.3	6.0	5.8
		20 + 50	1.94	4.86	-	1.2	6.8	7.6	290	1440	2800	6.7	6.4	6.1
		20 + 60	1.70	5.10	-	1.2	6.8	7.6	290	1440	2800	6.7	6.4	6.1
		25 + 25	3.20	3.20	-	1.2	6.4	7.6	290	1310	2800	6.1	5.8	5.6
		25 + 35	2.83	3.97	-	1.2	6.8	7.6	290	1440	2800	6.7	6.4	6.1
		25 + 50	2.27	4.53	-	1.2	6.8	7.6	290	1440	2800	6.7	6.4	6.1
		25 + 60	2.00	4.80	-	1.2	6.8	7.6	290	1440	2800	6.7	6.4	6.1
		35 + 35	3.40	3.40	-	1.2	6.8	7.6	290	1440	2800	6.7	6.4	6.1
		35 + 50	2.80	4.00	-	1.2	6.8	7.6	290	1440	2800	6.7	6.4	6.1
		35 + 60	2.51	4.29	-	1.2	6.8	7.6	290	1440	2800	6.7	6.4	6.1
		50 + 50	3.40	3.40	-	1.2	6.8	7.6	290	1440	2800	6.7	6.4	6.1
		50 + 60	3.09	3.71	-	1.2	6.8	7.6	290	1440	2800	6.7	6.4	6.1
		3 room	20 + 20 + 20	2.27	2.27	2.27	1.4	6.8	7.8	270	1400	2800	6.5	6.2
	20 + 20 + 25		2.09	2.09	2.62	1.4	6.8	7.8	270	1400	2800	6.5	6.2	6.0
	20 + 20 + 35		1.81	1.81	3.17	1.4	6.8	7.8	270	1400	2800	6.5	6.2	6.0
	20 + 20 + 50		1.51	1.51	3.78	1.4	6.8	7.8	270	1400	2800	6.5	6.2	6.0
	20 + 20 + 60		1.36	1.36	4.08	1.4	6.8	7.8	270	1400	2800	6.5	6.2	6.0
	20 + 25 + 25		1.94	2.43	2.43	1.4	6.8	7.8	270	1400	2800	6.5	6.2	6.0
	20 + 25 + 35		1.70	2.13	2.98	1.4	6.8	7.8	270	1400	2800	6.5	6.2	6.0
	20 + 25 + 50		1.43	1.79	3.58	1.4	6.8	7.8	270	1400	2800	6.5	6.2	6.0
	20 + 25 + 60		1.30	1.62	3.89	1.4	6.8	7.8	270	1400	2800	6.5	6.2	6.0
	20 + 35 + 35		1.51	2.64	2.64	1.4	6.8	7.8	270	1400	2800	6.5	6.2	6.0
	20 + 35 + 50		1.30	2.27	3.24	1.4	6.8	7.8	270	1400	2800	6.5	6.2	6.0
25 + 25 + 25	2.27		2.27	2.27	1.4	6.8	7.8	270	1400	2800	6.5	6.2	6.0	
25 + 25 + 35	2.00		2.00	2.80	1.4	6.8	7.8	270	1400	2800	6.5	6.2	6.0	
25 + 25 + 50	1.70		1.70	3.40	1.4	6.8	7.8	270	1400	2800	6.5	6.2	6.0	
25 + 25 + 60	1.55		1.55	3.71	1.4	6.8	7.8	270	1400	2800	6.5	6.2	6.0	
25 + 35 + 35	1.79	2.51	2.51	1.4	6.8	7.8	270	1400	2800	6.5	6.2	6.0		
25 + 35 + 50	1.55	2.16	3.09	1.4	6.8	7.8	270	1400	2800	6.5	6.2	6.0		
35 + 35 + 35	2.27	2.27	2.27	1.4	6.8	7.8	270	1400	2800	6.5	6.2	6.0		

Indoor unit combination		Cooling capacity (kW)						Power consumption(W)			Standard current(A)			
		Room heating capacity			Total capacity			Min.	Standard	Max.	220V	230V	240V	
		A	B	C	Min.	Standard	Max.							
Cooling operation	1 room	20	2.00	-	-	1.7	2.0	2.8	430	500	950	2.4	2.3	2.2
		25	2.50	-	-	1.7	2.5	3.4	430	680	1080	3.2	3.1	3.0
		35	3.50	-	-	1.7	3.5	3.9	430	1010	1240	4.7	4.5	4.3
		50	5.00	-	-	1.7	5.0	6.1	430	1530	2100	7.0	6.7	6.4
		60	6.00	-	-	1.7	6.0	6.3	430	1880	2280	8.6	8.3	7.9
	2 room	20 + 20	2.00	2.00	-	1.8	4.0	5.7	390	750	1750	3.5	3.3	3.2
		20 + 25	2.00	2.50	-	1.8	4.5	5.9	390	990	1910	4.6	4.4	4.2
		20 + 35	2.00	3.50	-	1.8	5.5	6.7	390	1320	2200	6.1	5.8	5.6
		20 + 50	1.71	4.29	-	1.8	6.0	6.9	390	1560	2280	7.2	6.9	6.6
		20 + 60	1.50	4.50	-	1.8	6.0	6.9	390	1560	2280	7.2	6.9	6.6
		25 + 25	2.50	2.50	-	1.8	5.0	6.5	390	1110	2150	5.1	4.9	4.7
		25 + 35	2.50	3.50	-	1.8	6.0	6.9	390	1560	2280	7.2	6.9	6.6
		25 + 50	2.00	4.00	-	1.8	6.0	6.9	390	1560	2280	7.2	6.9	6.6
		25 + 60	1.76	4.24	-	1.8	6.0	6.9	390	1560	2280	7.2	6.9	6.6
		35 + 35	3.00	3.00	-	1.8	6.0	6.9	390	1560	2280	7.2	6.9	6.6
		35 + 50	2.47	3.53	-	1.8	6.0	6.9	390	1560	2280	7.2	6.9	6.6
		35 + 60	2.21	3.79	-	1.8	6.0	6.9	390	1560	2280	7.2	6.9	6.6
		50 + 50	3.00	3.00	-	1.8	6.0	6.9	390	1560	2280	7.2	6.9	6.6
		50 + 60	2.73	3.27	-	1.8	6.0	6.9	390	1560	2280	7.2	6.9	6.6
		3 room	20 + 20 + 20	2.00	2.00	2.00	2.1	6.0	7.5	350	1320	2280	6.1	5.8
	20 + 20 + 25		1.85	1.85	2.31	2.1	6.0	7.5	350	1320	2280	6.1	5.8	5.6
	20 + 20 + 35		1.60	1.60	2.80	2.1	6.0	7.5	350	1320	2280	6.1	5.8	5.6
	20 + 20 + 50		1.33	1.33	3.33	2.1	6.0	7.5	350	1320	2280	6.1	5.8	5.6
	20 + 20 + 60		1.20	1.20	3.60	2.1	6.0	7.5	350	1320	2280	6.1	5.8	5.6
	20 + 25 + 25		1.71	2.14	2.14	2.1	6.0	7.5	350	1320	2280	6.1	5.8	5.6
	20 + 25 + 35		1.50	1.88	2.63	2.1	6.0	7.5	350	1320	2280	6.1	5.8	5.6
	20 + 25 + 50		1.26	1.58	3.16	2.1	6.0	7.5	350	1320	2280	6.1	5.8	5.6
	20 + 25 + 60		1.14	1.43	3.43	2.1	6.0	7.5	350	1320	2280	6.1	5.8	5.6
	20 + 35 + 35		1.33	2.33	2.33	2.1	6.0	7.5	350	1320	2280	6.1	5.8	5.6
	20 + 35 + 50		1.14	2.00	2.86	2.1	6.0	7.5	350	1320	2280	6.1	5.8	5.6
25 + 25 + 25	2.00		2.00	2.00	2.1	6.0	7.5	350	1320	2280	6.1	5.8	5.6	
25 + 25 + 35	1.76		1.76	2.47	2.1	6.0	7.5	350	1320	2280	6.1	5.8	5.6	
25 + 25 + 50	1.50		1.50	3.00	2.1	6.0	7.5	350	1320	2280	6.1	5.8	5.6	
25 + 25 + 60	1.36		1.36	3.27	2.1	6.0	7.5	350	1320	2280	6.1	5.8	5.6	
25 + 35 + 35	1.58	2.21	2.21	2.1	6.0	7.5	350	1320	2280	6.1	5.8	5.6		
25 + 35 + 50	1.36	1.91	2.73	2.1	6.0	7.5	350	1320	2280	6.1	5.8	5.6		
35 + 35 + 35	2.00	2.00	2.00	2.1	6.0	7.5	350	1320	2280	6.1	5.8	5.6		

COMBINATIONS

SCM60ZS-W Table of Indoor unit combination with other indoor unit

Indoor unit combination		Heating capacity (kW)						Power consumption(W)			Standard current(A)			
		Room heating capacity			Total capacity			Min.	Standard	Max.	220V	230V	240V	
		A	B	C	Min.	Standard	Max.							
Heating operation	1 room	20	3.00	-	-	1.0	3.0	3.5	320	970	1330	4.5	4.3	4.1
		25	3.40	-	-	1.0	3.4	4.0	320	1140	1510	5.3	5.1	4.8
		35	4.50	-	-	1.0	4.5	4.8	320	1480	1790	6.9	6.6	6.3
		50	5.80	-	-	1.0	5.8	6.1	320	1910	2310	8.9	8.5	8.1
		60	6.80	-	-	1.0	6.8	7.0	320	2200	2660	10.2	9.8	9.4
	2 room	20 + 20	2.70	2.70	-	1.2	5.4	7.0	290	1250	2100	5.8	5.5	5.3
		20 + 25	2.62	3.28	-	1.2	5.9	7.2	290	1380	2550	6.4	6.1	5.9
		20 + 35	2.40	4.20	-	1.2	6.6	7.3	290	1560	2800	7.2	6.9	6.6
		20 + 50	1.94	4.86	-	1.2	6.8	7.3	290	1640	2800	7.6	7.3	7.0
		20 + 60	1.70	5.10	-	1.2	6.8	7.3	290	1640	2800	7.6	7.3	7.0
		25 + 25	3.20	3.20	-	1.2	6.4	7.3	290	1510	2800	7.0	6.7	6.4
		25 + 35	2.83	3.97	-	1.2	6.8	7.3	290	1640	2800	7.6	7.3	7.0
		25 + 50	2.27	4.53	-	1.2	6.8	7.3	290	1640	2800	7.6	7.3	7.0
		25 + 60	2.00	4.80	-	1.2	6.8	7.3	290	1640	2800	7.6	7.3	7.0
		35 + 35	3.40	3.40	-	1.2	6.8	7.3	290	1640	2800	7.6	7.3	7.0
		35 + 50	2.80	4.00	-	1.2	6.8	7.3	290	1640	2800	7.6	7.3	7.0
		35 + 60	2.51	4.29	-	1.2	6.8	7.3	290	1640	2800	7.6	7.3	7.0
		50 + 50	3.40	3.40	-	1.2	6.8	7.3	290	1640	2800	7.6	7.3	7.0
		50 + 60	3.09	3.71	-	1.2	6.8	7.3	290	1640	2800	7.6	7.3	7.0
		3 room	20 + 20 + 20	2.27	2.27	2.27	1.4	6.8	7.6	270	1500	2800	7.0	6.7
	20 + 20 + 25		2.09	2.09	2.62	1.4	6.8	7.6	270	1500	2800	7.0	6.7	6.4
	20 + 20 + 35		1.81	1.81	3.17	1.4	6.8	7.6	270	1500	2800	7.0	6.7	6.4
	20 + 20 + 50		1.51	1.51	3.78	1.4	6.8	7.6	270	1500	2800	7.0	6.7	6.4
	20 + 20 + 60		1.36	1.36	4.08	1.4	6.8	7.6	270	1500	2800	7.0	6.7	6.4
	20 + 25 + 25		1.94	2.43	2.43	1.4	6.8	7.6	270	1500	2800	7.0	6.7	6.4
	20 + 25 + 35		1.70	2.13	2.98	1.4	6.8	7.6	270	1500	2800	7.0	6.7	6.4
	20 + 25 + 50		1.43	1.79	3.58	1.4	6.8	7.6	270	1500	2800	7.0	6.7	6.4
	20 + 25 + 60		1.30	1.62	3.89	1.4	6.8	7.6	270	1500	2800	7.0	6.7	6.4
	20 + 35 + 35		1.51	2.64	2.64	1.4	6.8	7.6	270	1500	2800	7.0	6.7	6.4
	20 + 35 + 50		1.30	2.27	3.24	1.4	6.8	7.6	270	1500	2800	7.0	6.7	6.4
	25 + 25 + 25		2.27	2.27	2.27	1.4	6.8	7.6	270	1500	2800	7.0	6.7	6.4
	25 + 25 + 35		2.00	2.00	2.80	1.4	6.8	7.6	270	1500	2800	7.0	6.7	6.4
	25 + 25 + 50	1.70	1.70	3.40	1.4	6.8	7.6	270	1500	2800	7.0	6.7	6.4	
25 + 25 + 60	1.55	1.55	3.71	1.4	6.8	7.6	270	1500	2800	7.0	6.7	6.4		
25 + 35 + 35	1.79	2.51	2.51	1.4	6.8	7.6	270	1500	2800	7.0	6.7	6.4		
25 + 35 + 50	1.55	2.16	3.09	1.4	6.8	7.6	270	1500	2800	7.0	6.7	6.4		
35 + 35 + 35	2.27	2.27	2.27	1.4	6.8	7.6	270	1500	2800	7.0	6.7	6.4		

Indoor unit combination		Cooling capacity (kW)						Power consumption(W)			Standard current(A)			
		Room heating capacity			Total capacity			Min.	Standard	Max.	220V	230V	240V	
		A	B	C	Min.	Standard	Max.							
Cooling operation	1 room	20	2.00	-	-	1.7	2.0	2.7	430	570	950	2.7	2.6	2.5
		25	2.50	-	-	1.7	2.5	3.2	430	760	1080	3.6	3.4	3.3
		35	3.50	-	-	1.7	3.5	3.7	430	1150	1240	5.3	5.1	4.9
		50	5.00	-	-	1.7	5.0	5.8	430	1860	2100	8.5	8.2	7.8
		60	6.00	-	-	1.7	6.0	6.1	430	2140	2280	9.8	9.4	9.0
	2 room	20 + 20	2.00	2.00	-	1.8	4.0	5.6	390	800	1750	3.7	3.5	3.4
		20 + 25	2.00	2.50	-	1.8	4.5	5.8	390	1050	1910	4.8	4.6	4.4
		20 + 35	2.00	3.50	-	1.8	5.5	6.1	390	1620	2110	7.4	7.1	6.8
		20 + 50	1.71	4.29	-	1.8	6.0	6.7	390	1930	2280	8.9	8.5	8.1
		20 + 60	1.50	4.50	-	1.8	6.0	6.7	390	1930	2280	8.9	8.5	8.1
		25 + 25	2.50	2.50	-	1.8	5.0	6.1	390	1340	2110	6.2	5.9	5.6
		25 + 35	2.50	3.50	-	1.8	6.0	6.7	390	1930	2280	8.9	8.5	8.1
		25 + 50	2.00	4.00	-	1.8	6.0	6.7	390	1930	2280	8.9	8.5	8.1
		25 + 60	1.76	4.24	-	1.8	6.0	6.7	390	1930	2280	8.9	8.5	8.1
		35 + 35	3.00	3.00	-	1.8	6.0	6.7	390	1930	2280	8.9	8.5	8.1
		35 + 50	2.47	3.53	-	1.8	6.0	6.7	390	1930	2280	8.9	8.5	8.1
		35 + 60	2.21	3.79	-	1.8	6.0	6.7	390	1930	2280	8.9	8.5	8.1
		50 + 50	3.00	3.00	-	1.8	6.0	6.7	390	1930	2280	8.9	8.5	8.1
		50 + 60	2.73	3.27	-	1.8	6.0	6.7	390	1930	2280	8.9	8.5	8.1
		3 room	20 + 20 + 20	2.00	2.00	2.00	2.1	6.0	7.3	350	1430	2280	6.6	6.3
	20 + 20 + 25		1.85	1.85	2.31	2.1	6.0	7.3	350	1430	2280	6.6	6.3	6.0
	20 + 20 + 35		1.60	1.60	2.80	2.1	6.0	7.3	350	1430	2280	6.6	6.3	6.0
	20 + 20 + 50		1.33	1.33	3.33	2.1	6.0	7.3	350	1430	2280	6.6	6.3	6.0
	20 + 20 + 60		1.20	1.20	3.60	2.1	6.0	7.3	350	1430	2280	6.6	6.3	6.0
	20 + 25 + 25		1.71	2.14	2.14	2.1	6.0	7.3	350	1430	2280	6.6	6.3	6.0
	20 + 25 + 35		1.50	1.88	2.63	2.1	6.0	7.3	350	1430	2280	6.6	6.3	6.0
	20 + 25 + 50		1.26	1.58	3.16	2.1	6.0	7.3	350	1430	2280	6.6	6.3	6.0
	20 + 25 + 60		1.14	1.43	3.43	2.1	6.0	7.3	350	1430	2280	6.6	6.3	6.0
	20 + 35 + 35		1.33	2.33	2.33	2.1	6.0	7.3	350	1430	2280	6.6	6.3	6.0
	20 + 35 + 50		1.14	2.00	2.86	2.1	6.0	7.3	350	1430	2280	6.6	6.3	6.0
	25 + 25 + 25		2.00	2.00	2.00	2.1	6.0	7.3	350	1430	2280	6.6	6.3	6.0
	25 + 25 + 35		1.76	1.76	2.47	2.1	6.0	7.3	350	1430	2280	6.6	6.3	6.0
	25 + 25 + 50	1.50	1.50	3.00	2.1	6.0	7.3	350	1430	2280	6.6	6.3	6.0	
25 + 25 + 60	1.36	1.36	3.27	2.1	6.0	7.3	350	1430	2280	6.6	6.3	6.0		
25 + 35 + 35	1.58	2.21	2.21	2.1	6.0	7.3	350	1430	2280	6.6	6.3	6.0		
25 + 35 + 50	1.36	1.91	2.73	2.1	6.0	7.3	350	1430	2280	6.6	6.3	6.0		
35 + 35 + 35	2.00	2.00	2.00	2.1	6.0	7.3	350	1430	2280	6.6	6.3	6.0		



MULTI-SPLIT SYSTEM

SCM71ZS-W Table of Indoor unit combination only with SRK-ZSX type

Indoor unit combination		Heating capacity (kW)							Power consumption(W)			Standard current(A)			
		Room heating capacity				Total capacity			Min.	Standard	Max.	220V	230V	240V	
		A	B	C	D	Min.	Standard	Max.							
1 room	20	3.00	-	-	-	1.1	3.0	3.7	390	840	1330	4.0	3.8	3.6	
	25	3.40	-	-	-	1.1	3.4	4.2	390	1000	1510	4.7	4.5	4.3	
	35	4.50	-	-	-	1.1	4.5	5.0	390	1330	1790	6.2	5.9	5.7	
	50	5.80	-	-	-	1.1	5.8	6.5	390	1780	2310	8.3	7.9	7.6	
	60	6.80	-	-	-	1.1	6.8	7.5	390	2100	2660	9.7	9.3	8.9	
2 room	20 + 20	2.70	2.70	-	-	1.5	5.4	7.4	350	1280	1870	6.0	5.7	5.5	
	20 + 25	2.62	3.28	-	-	1.5	5.9	7.7	350	1410	2130	6.6	6.3	6.0	
	20 + 35	2.51	4.39	-	-	1.5	6.9	8.3	350	1680	2650	7.8	7.5	7.1	
	20 + 50	2.46	6.14	-	-	1.5	8.6	8.9	350	2100	3000	9.7	9.3	8.9	
	20 + 60	2.15	6.45	-	-	1.5	8.6	8.9	350	2100	3000	9.7	9.3	8.9	
	25 + 25	3.20	3.20	-	-	1.5	6.4	8.1	350	1540	2480	7.1	6.8	6.5	
	25 + 35	3.08	4.32	-	-	1.5	7.4	8.6	350	1810	2910	8.4	8.0	7.7	
	25 + 50	2.87	5.73	-	-	1.5	8.6	8.9	350	2100	3000	9.7	9.3	8.9	
	25 + 60	2.53	6.07	-	-	1.5	8.6	8.9	350	2100	3000	9.7	9.3	8.9	
	35 + 35	4.30	4.30	-	-	1.5	8.6	8.9	350	2100	3000	9.7	9.3	8.9	
	35 + 50	3.54	5.06	-	-	1.5	8.6	8.9	350	2100	3000	9.7	9.3	8.9	
	35 + 60	3.17	5.43	-	-	1.5	8.6	8.9	350	2100	3000	9.7	9.3	8.9	
	50 + 50	4.30	4.30	-	-	1.5	8.6	8.9	350	2100	3000	9.7	9.3	8.9	
	50 + 60	3.91	4.69	-	-	1.5	8.6	8.9	350	2100	3000	9.7	9.3	8.9	
	60 + 60	4.30	4.30	-	-	1.5	8.6	8.9	350	2100	3000	9.7	9.3	8.9	
3 room	20 + 20 + 20	2.57	2.57	2.57	-	1.6	7.7	9.1	370	1830	3000	8.5	8.1	7.8	
	20 + 20 + 25	2.46	2.46	3.08	-	1.6	8.0	9.1	370	1930	3000	9.0	8.6	8.2	
	20 + 20 + 35	2.29	2.29	4.01	-	1.6	8.6	9.1	370	2060	3000	9.6	9.1	8.8	
	20 + 20 + 50	1.91	1.91	4.78	-	1.6	8.6	9.1	370	2060	3000	9.6	9.1	8.8	
	20 + 20 + 60	1.72	1.72	5.16	-	1.6	8.6	9.1	370	2060	3000	9.6	9.1	8.8	
	20 + 25 + 25	2.46	3.07	3.07	-	1.6	8.6	9.1	370	2060	3000	9.6	9.1	8.8	
	20 + 25 + 35	2.15	2.69	3.76	-	1.6	8.6	9.1	370	2060	3000	9.6	9.1	8.8	
	20 + 25 + 50	1.81	2.26	4.53	-	1.6	8.6	9.1	370	2060	3000	9.6	9.1	8.8	
	20 + 25 + 60	1.64	2.05	4.91	-	1.6	8.6	9.1	370	2060	3000	9.6	9.1	8.8	
	20 + 35 + 35	1.91	3.34	3.34	-	1.6	8.6	9.1	370	2060	3000	9.6	9.1	8.8	
	20 + 35 + 50	1.64	2.87	4.10	-	1.6	8.6	9.1	370	2060	3000	9.6	9.1	8.8	
	20 + 35 + 60	1.50	2.62	4.49	-	1.6	8.6	9.1	370	2060	3000	9.6	9.1	8.8	
	20 + 50 + 50	1.43	3.58	3.58	-	1.6	8.6	9.1	370	2060	3000	9.6	9.1	8.8	
	25 + 25 + 25	2.87	2.87	2.87	-	1.6	8.6	9.1	370	2060	3000	9.6	9.1	8.8	
	25 + 25 + 35	2.53	2.53	3.54	-	1.6	8.6	9.1	370	2060	3000	9.6	9.1	8.8	
	25 + 25 + 50	2.15	2.15	4.30	-	1.6	8.6	9.1	370	2060	3000	9.6	9.1	8.8	
	25 + 25 + 60	1.95	1.95	4.69	-	1.6	8.6	9.1	370	2060	3000	9.6	9.1	8.8	
	25 + 35 + 35	2.26	3.17	3.17	-	1.6	8.6	9.1	370	2060	3000	9.6	9.1	8.8	
	25 + 35 + 50	1.95	2.74	3.91	-	1.6	8.6	9.1	370	2060	3000	9.6	9.1	8.8	
	25 + 35 + 60	1.79	2.51	4.30	-	1.6	8.6	9.1	370	2060	3000	9.6	9.1	8.8	
	25 + 50 + 50	1.72	3.44	3.44	-	1.6	8.6	9.1	370	2060	3000	9.6	9.1	8.8	
	35 + 35 + 35	2.87	2.87	2.87	-	1.6	8.6	9.1	370	2060	3000	9.6	9.1	8.8	
	35 + 35 + 50	2.51	2.51	3.58	-	1.6	8.6	9.1	370	2060	3000	9.6	9.1	8.8	
	4 room	20 + 20 + 20 + 20	2.15	2.15	2.15	2.15	1.7	8.6	9.4	350	1750	3000	8.1	7.8	7.4
		20 + 20 + 20 + 25	2.02	2.02	2.02	2.53	1.7	8.6	9.4	350	1750	3000	8.1	7.8	7.4
20 + 20 + 20 + 35		1.81	1.81	1.81	3.17	1.7	8.6	9.4	350	1750	3000	8.1	7.8	7.4	
20 + 20 + 20 + 50		1.56	1.56	1.56	3.91	1.7	8.6	9.4	350	1750	3000	8.1	7.8	7.4	
20 + 20 + 20 + 60		1.43	1.43	1.43	4.30	1.7	8.6	9.4	350	1750	3000	8.1	7.8	7.4	
20 + 20 + 25 + 25		1.91	1.91	2.39	2.39	1.7	8.6	9.4	350	1750	3000	8.1	7.8	7.4	
20 + 20 + 25 + 35		1.72	1.72	2.15	3.01	1.7	8.6	9.4	350	1750	3000	8.1	7.8	7.4	
20 + 20 + 25 + 50		1.50	1.50	1.87	3.74	1.7	8.6	9.4	350	1750	3000	8.1	7.8	7.4	
20 + 20 + 25 + 60		1.38	1.38	1.72	4.13	1.7	8.6	9.4	350	1750	3000	8.1	7.8	7.4	
20 + 20 + 35 + 35		1.56	1.56	2.74	2.74	1.7	8.6	9.4	350	1750	3000	8.1	7.8	7.4	
20 + 20 + 35 + 50		1.38	1.38	2.41	3.44	1.7	8.6	9.4	350	1750	3000	8.1	7.8	7.4	
20 + 25 + 25 + 25		1.81	2.26	2.26	2.26	1.7	8.6	9.4	350	1750	3000	8.1	7.8	7.4	
20 + 25 + 25 + 35		1.64	2.05	2.05	2.87	1.7	8.6	9.4	350	1750	3000	8.1	7.8	7.4	
20 + 25 + 25 + 50		1.43	1.79	1.79	3.58	1.7	8.6	9.4	350	1750	3000	8.1	7.8	7.4	
20 + 25 + 35 + 35		1.50	1.87	2.62	2.62	1.7	8.6	9.4	350	1750	3000	8.1	7.8	7.4	
20 + 35 + 35 + 35	1.38	2.41	2.41	2.41	1.7	8.6	9.4	350	1750	3000	8.1	7.8	7.4		
25 + 25 + 25 + 25	2.15	2.15	2.15	2.15	1.7	8.6	9.4	350	1750	3000	8.1	7.8	7.4		
25 + 25 + 25 + 35	1.95	1.95	1.95	2.74	1.7	8.6	9.4	350	1750	3000	8.1	7.8	7.4		
25 + 25 + 25 + 50	1.72	1.72	1.72	3.44	1.7	8.6	9.4	350	1750	3000	8.1	7.8	7.4		
25 + 25 + 35 + 35	1.79	1.79	2.51	2.51	1.7	8.6	9.4	350	1750	3000	8.1	7.8	7.4		

COMBINATIONS

Indoor unit combination		Cooling capacity (kW)							Power consumption(W)			Standard current(A)		
		Room cooling capacity				Total capacity			Min.	Standard	Max.	220V	230V	240V
		A	B	C	D	Min.	Standard	Max.						
1 room	20	2.00	-	-	-	1.8	2.0	3.4	480	500	950	2.4	2.3	2.2
	25	2.50	-	-	-	1.8	2.5	3.8	480	680	1080	3.2	3.1	3.0
	35	3.50	-	-	-	1.8	3.5	4.5	480	1010	1240	4.7	4.5	4.3
	50	5.00	-	-	-	1.8	5.0	6.2	480	1530	2100	7.0	6.7	6.4
	60	6.00	-	-	-	1.8	6.0	6.9	480	1880	2700	8.6	8.3	7.9
2 room	20 + 20	2.00	2.00	-	-	3.0	4.0	6.1	550	840	1910	4.0	3.8	3.6
	20 + 25	2.00	2.50	-	-	3.0	4.5	6.4	550	990	2060	4.6	4.4	4.3
	20 + 35	2.00	3.50	-	-	3.0	5.5	6.9	550	1320	2320	6.1	5.8	5.6
	20 + 50	2.03	5.07	-	-	3.0	7.1	7.7	550	1970	2750	9.0	8.7	8.3
	20 + 60	1.78	5.33	-	-	3.0	7.1	7.7	550	1970	2750	9.0	8.7	8.3
	25 + 25	2.50	2.50	-	-	3.0	5.0	6.8	550	1150	2270	5.4	5.1	4.9
	25 + 35	2.46	3.44	-	-	3.0	5.9	7.2	550	1470	2470	6.8	6.5	6.2
	25 + 50	2.37	4.73	-	-	3.0	7.1	7.7	550	1970	2750	9.0	8.7	8.3
	25 + 60	2.09	5.01	-	-	3.0	7.1	7.7	550	1970	2750	9.0	8.7	8.3
	35 + 35	3.55	3.55	-	-	3.0	7.1	7.7	550	1970	2750	9.0	8.7	8.3
	35 + 50	2.92	4.18	-	-	3.0	7.1	7.7	550	1970	2750	9.0	8.7	8.3
	35 + 60	2.62	4.48	-	-	3.0	7.1	7.7	550	1970	2750	9.0	8.7	8.3
	50 + 50	3.55	3.55	-	-	3.0	7.1	7.7	550	1970	2750	9.0	8.7	8.3
	50 + 60	3.23	3.87	-	-	3.0	7.1	7.7	550	1970	2750	9.0	8.7	8.3
	60 + 60	3.55	3.55	-	-	3.0	7.1	7.7	550	1970	2750	9.0	8.7	8.3
3 room	20 + 20 + 20	2.00	2.00	2.00	-	3.7	6.0	8.2	670	1240	2750	5.8	5.5	5.3
	20 + 20 + 25	2.00	2.00	2.50	-	3.7	6.5	8.2	670	1390	2750	6.4	6.1	5.9
	20 + 20 + 35	1.89	1.89	3.31	-	3.7	7.1	8.2	670	1520	2750	7.0	6.7	6.4
	20 + 20 + 50	1.58	1.58	3.94	-	3.7	7.1	8.2	670	1520	2750	7.0	6.7	6.4
	20 + 20 + 60	1.42	1.42	4.26	-	3.7	7.1	8.2	670	1520	2750	7.0	6.7	6.4
	20 + 25 + 25	2.03	2.54	2.54	-	3.7	7.1	8.2	670	1520	2750	7.0	6.7	6.4
	20 + 25 + 35	1.78	2.22	3.11	-	3.7	7.1	8.2	670	1520	2750	7.0	6.7	6.4
	20 + 25 + 50	1.49	1.87	3.74	-	3.7	7.1	8.2	670	1520	2750	7.0	6.7	6.4
	20 + 25 + 60	1.35	1.69	4.06	-	3.7	7.1	8.2	670	1520	2750	7.0	6.7	6.4
	20 + 35 + 35	1.58	2.76	2.76	-	3.7	7.1	8.2	670	1520	2750	7.0	6.7	6.4
	20 + 35 + 50	1.35	2.37	3.38	-	3.7	7.1	8.2	670	1520	2750	7.0	6.7	6.4
	20 + 35 + 60	1.23	2.16	3.70	-	3.7	7.1	8.2	670	1520	2750	7.0	6.7	6.4
	20 + 50 + 50	1.18	2.96	2.96	-	3.7	7.1	8.2	670	1520	2750	7.0	6.7	6.4
	25 + 25 + 25	2.37	2.37	2.37	-	3.7	7.1	8.2	670	1520	2750	7.0	6.7	6.4
	25 + 25 + 35	2.09	2.09	2.92	-	3.7	7.1	8.2	670	1520	2750	7.0	6.7	6.4
	25 + 25 + 50	1.78	1.78	3.55	-	3.7	7.1	8.2	670	1520	2750	7.0	6.7	6.4
	25 + 25 + 60	1.61	1.61	3.87	-	3.7	7.1	8.2	670	1520	2750	7.0	6.7	6.4
	25 + 35 + 35	1.87	2.62	2.62	-	3.7	7.1	8.2	670	1520	2750	7.0	6.7	6.4
	25 + 35 + 50	1.61	2.26	3.23	-	3.7	7.1	8.2	670	1520	2750	7.0	6.7	6.4
	25 + 35 + 60	1.48	2.07	3.55	-	3.7	7.1	8.2	670	1520	2750	7.0	6.7	6.4
25 + 50 + 50	1.42	2.84	2.84	-	3.7	7.1	8.2	670	1520	2750	7.0	6.7	6.4	
35 + 35 + 35	2.37	2.37	2.37	-	3.7	7.1	8.2	670	1520	2750	7.0	6.7	6.4	
35 + 35 + 50	2.07	2.07	2.96	-	3.7	7.1	8.2	670	1520	2750	7.0	6.7	6.4	
4 room	20 + 20 + 20 + 20	1.78	1.78	1.78	1.78	4.4	7.1	8.8	890	1420	2750	6.5	6.2	6.0
	20 + 20 + 20 + 25	1.67	1.67	1.67	2.09	4.4	7.1	8.8	890	1420	2750	6.5	6.2	6.0
	20 + 20 + 20 + 35	1.49	1.49	1.49	2.62	4.4	7.1	8.8	890	1420	2750	6.5	6.2	6.0
	20 + 20 + 20 + 50	1.29	1.29	1.29	3.23	4.4	7.1	8.8	890	1420	2750	6.5	6.2	6.0
	20 + 20 + 20 + 60	1.18	1.18	1.18	3.55	4.4	7.1	8.8	890	1420	2750	6.5	6.2	6.0
	20 + 20 + 25 + 25	1.58	1.58	1.97	1.97	4.4	7.1	8.8	890	1420	2750	6.5	6.2	6.0
	20 + 20 + 25 + 35	1.42	1.42	1.78	2.49	4.4	7.1	8.8	890	1420	2750	6.5	6.2	6.0
	20 + 20 + 25 + 50	1.23	1.23	1.54	3.09	4.4	7.1	8.8	890	1420	2750	6.5	6.2	6.0
	20 + 20 + 25 + 60	1.14	1.14	1.42	3.41	4.4	7.1	8.8	890	1420	2750	6.5	6.2	6.0
	20 + 20 + 35 + 35	1.29	1.29	2.26	2.26	4.4	7.1	8.8	890	1420	2750	6.5	6.2	6.0
	20 + 20 + 35 + 50	1.14	1.14	1.99	2.84	4.4	7.1	8.8	890	1420	2750	6.5	6.2	6.0
	20 + 25 + 25 + 25	1.49	1.87	1.87	1.87	4.4	7.1	8.8	890	1420	2750	6.5	6.2	6.0
	20 + 25 + 25 + 35	1.35	1.69	1.69	2.37	4.4	7.1	8.8	890	1420	2750	6.5	6.2	6.0
	20 + 25 + 25 + 50	1.18	1.48	1.48	2.96	4.4	7.1	8.8	890	1420	2750	6.5	6.2	6.0
	20 + 25 + 35 + 35	1.23	1.54	2.16	2.16	4.4	7.1	8.8	890	1420	2750	6.5	6.2	6.0
20 + 35 + 35 + 35	1.14	1.99	1.99	1.99	4.4	7.1	8.8	890	1420	2750	6.5	6.2	6.0	
25 + 25 + 25 + 25	1.78	1.78	1.78	1.78	4.4	7.1	8.8	890	1420	2750	6.5	6.2	6.0	
25 + 25 + 25 + 35	1.61	1.61	1.61	2.26	4.4	7.1	8.8	890	1420	2750	6.5	6.2	6.0	
25 + 25 + 25 + 50	1.42	1.42	1.42	2.84	4.4	7.1	8.8	890	1420	2750	6.5	6.2	6.0	
25 + 25 + 35 + 35	1.48	1.48	2.07	2.07	4.4	7.1	8.8	890	1420	2750	6.5	6.2	6.0	



MULTI-SPLIT SYSTEM

SCM71ZS-W Table of Indoor unit combination with other indoor unit

Indoor unit combination		Heating capacity (kW)							Power consumption(W)			Standard current(A)		
		Room heating capacity				Total capacity			Min.	Standard	Max.	220V	230V	240V
		A	B	C	D	Min.	Standard	Max.						
1 room	20	3.00	-	-	-	1.1	3.0	3.5	390	1060	1330	5.0	4.8	4.6
	25	3.40	-	-	-	1.1	3.4	4.0	390	1220	1510	5.7	5.5	5.2
	35	4.50	-	-	-	1.1	4.5	4.8	390	1510	1790	7.0	6.7	6.4
	50	5.80	-	-	-	1.1	5.8	6.2	390	1950	2310	9.0	8.7	8.3
	60	6.80	-	-	-	1.1	6.8	7.1	390	2240	2660	10.4	9.9	9.5
2 room	71	8.00	-	-	-	1.1	8.0	8.1	390	2740	3000	12.7	12.2	11.6
	20 + 20	2.70	2.70	-	-	1.5	5.4	7.0	350	1370	1870	6.4	6.1	5.9
	20 + 25	2.62	3.28	-	-	1.5	5.9	7.3	350	1560	2130	7.3	6.9	6.7
	20 + 35	2.51	4.39	-	-	1.5	6.9	7.9	350	1950	2650	9.0	8.7	8.3
	20 + 50	2.46	6.14	-	-	1.5	8.6	8.7	350	2460	3000	11.4	10.9	10.5
	20 + 60	2.15	6.45	-	-	1.5	8.6	8.7	350	2460	3000	11.4	10.9	10.5
	20 + 71	1.89	6.71	-	-	1.5	8.6	8.7	350	2460	3000	11.4	10.9	10.5
	25 + 25	3.20	3.20	-	-	1.5	6.4	7.7	350	1740	2480	8.1	7.7	7.4
	25 + 35	3.08	4.32	-	-	1.5	7.4	8.2	350	2130	2910	9.9	9.4	9.1
	25 + 50	2.87	5.73	-	-	1.5	8.6	8.7	350	2460	3000	11.4	10.9	10.5
	25 + 60	2.53	6.07	-	-	1.5	8.6	8.7	350	2460	3000	11.4	10.9	10.5
	25 + 71	2.24	6.36	-	-	1.5	8.6	8.7	350	2460	3000	11.4	10.9	10.5
	35 + 35	4.30	4.30	-	-	1.5	8.6	8.7	350	2460	3000	11.4	10.9	10.5
	35 + 50	3.54	5.06	-	-	1.5	8.6	8.7	350	2460	3000	11.4	10.9	10.5
	35 + 60	3.17	5.43	-	-	1.5	8.6	8.7	350	2460	3000	11.4	10.9	10.5
35 + 71	2.84	5.76	-	-	1.5	8.6	8.7	350	2460	3000	11.4	10.9	10.5	
50 + 50	4.30	4.30	-	-	1.5	8.6	8.7	350	2460	3000	11.4	10.9	10.5	
50 + 60	3.91	4.69	-	-	1.5	8.6	8.7	350	2460	3000	11.4	10.9	10.5	
50 + 71	3.55	5.05	-	-	1.5	8.6	8.7	350	2460	3000	11.4	10.9	10.5	
60 + 60	4.30	4.30	-	-	1.5	8.6	8.7	350	2460	3000	11.4	10.9	10.5	
3 room	20 + 20 + 20	2.57	2.57	2.57	-	1.6	7.7	8.9	370	1870	3000	8.7	8.3	8.0
	20 + 20 + 25	2.46	2.46	3.08	-	1.6	8.0	8.9	370	1970	3000	9.1	8.7	8.4
	20 + 20 + 35	2.29	2.29	4.01	-	1.6	8.6	8.9	370	2410	3000	11.2	10.7	10.2
	20 + 20 + 50	1.91	1.91	4.78	-	1.6	8.6	8.9	370	2410	3000	11.2	10.7	10.2
	20 + 20 + 60	1.72	1.72	5.16	-	1.6	8.6	8.9	370	2410	3000	11.2	10.7	10.2
	20 + 20 + 71	1.55	1.55	5.50	-	1.6	8.6	8.9	370	2410	3000	11.2	10.7	10.2
	20 + 25 + 25	2.46	3.07	3.07	-	1.6	8.6	8.9	370	2410	3000	11.2	10.7	10.2
	20 + 25 + 35	2.15	2.69	3.76	-	1.6	8.6	8.9	370	2410	3000	11.2	10.7	10.2
	20 + 25 + 50	1.81	2.26	4.53	-	1.6	8.6	8.9	370	2410	3000	11.2	10.7	10.2
	20 + 25 + 60	1.64	2.05	4.91	-	1.6	8.6	8.9	370	2410	3000	11.2	10.7	10.2
	20 + 25 + 71	1.48	1.85	5.26	-	1.6	8.6	8.9	370	2410	3000	11.2	10.7	10.2
	20 + 35 + 35	1.91	3.34	3.34	-	1.6	8.6	8.9	370	2410	3000	11.2	10.7	10.2
	20 + 35 + 50	1.64	2.87	4.10	-	1.6	8.6	8.9	370	2410	3000	11.2	10.7	10.2
	20 + 35 + 60	1.50	2.62	4.49	-	1.6	8.6	8.9	370	2410	3000	11.2	10.7	10.2
	20 + 35 + 71	1.37	2.39	4.85	-	1.6	8.6	8.9	370	2410	3000	11.2	10.7	10.2
	20 + 50 + 50	1.43	3.58	3.58	-	1.6	8.6	8.9	370	2410	3000	11.2	10.7	10.2
	25 + 25 + 25	2.87	2.87	2.87	-	1.6	8.6	8.9	370	2410	3000	11.2	10.7	10.2
	25 + 25 + 35	2.53	2.53	3.54	-	1.6	8.6	8.9	370	2410	3000	11.2	10.7	10.2
	25 + 25 + 50	2.15	2.15	4.30	-	1.6	8.6	8.9	370	2410	3000	11.2	10.7	10.2
	25 + 25 + 60	1.95	1.95	4.69	-	1.6	8.6	8.9	370	2410	3000	11.2	10.7	10.2
25 + 25 + 71	1.78	1.78	5.05	-	1.6	8.6	8.9	370	2410	3000	11.2	10.7	10.2	
25 + 35 + 35	2.26	3.17	3.17	-	1.6	8.6	8.9	370	2410	3000	11.2	10.7	10.2	
25 + 35 + 50	1.95	2.74	3.91	-	1.6	8.6	8.9	370	2410	3000	11.2	10.7	10.2	
25 + 35 + 60	1.79	2.51	4.30	-	1.6	8.6	8.9	370	2410	3000	11.2	10.7	10.2	
25 + 50 + 50	1.72	3.44	3.44	-	1.6	8.6	8.9	370	2410	3000	11.2	10.7	10.2	
35 + 35 + 35	2.87	2.87	2.87	-	1.6	8.6	8.9	370	2410	3000	11.2	10.7	10.2	
35 + 35 + 50	2.51	2.51	3.58	-	1.6	8.6	8.9	370	2410	3000	11.2	10.7	10.2	
4 room	20 + 20 + 20 + 20	2.15	2.15	2.15	2.15	1.7	8.6	9.1	350	1990	3000	9.2	8.8	8.5
	20 + 20 + 20 + 25	2.02	2.02	2.02	2.53	1.7	8.6	9.1	350	1990	3000	9.2	8.8	8.5
	20 + 20 + 20 + 35	1.81	1.81	1.81	3.17	1.7	8.6	9.1	350	1990	3000	9.2	8.8	8.5
	20 + 20 + 20 + 50	1.56	1.56	1.56	3.91	1.7	8.6	9.1	350	1990	3000	9.2	8.8	8.5
	20 + 20 + 20 + 60	1.43	1.43	1.43	4.30	1.7	8.6	9.1	350	1990	3000	9.2	8.8	8.5
	20 + 20 + 25 + 25	1.91	1.91	2.39	2.39	1.7	8.6	9.1	350	1990	3000	9.2	8.8	8.5
	20 + 20 + 25 + 35	1.72	1.72	2.15	3.01	1.7	8.6	9.1	350	1990	3000	9.2	8.8	8.5
	20 + 20 + 25 + 50	1.50	1.50	1.87	3.74	1.7	8.6	9.1	350	1990	3000	9.2	8.8	8.5
	20 + 20 + 25 + 60	1.38	1.38	1.72	4.13	1.7	8.6	9.1	350	1990	3000	9.2	8.8	8.5
	20 + 20 + 35 + 35	1.56	1.56	2.74	2.74	1.7	8.6	9.1	350	1990	3000	9.2	8.8	8.5
	20 + 20 + 35 + 50	1.38	1.38	2.41	3.44	1.7	8.6	9.1	350	1990	3000	9.2	8.8	8.5
	20 + 25 + 25 + 25	1.81	2.26	2.26	2.26	1.7	8.6	9.1	350	1990	3000	9.2	8.8	8.5
	20 + 25 + 25 + 35	1.64	2.05	2.05	2.87	1.7	8.6	9.1	350	1990	3000	9.2	8.8	8.5
	20 + 25 + 25 + 50	1.43	1.79	1.79	3.58	1.7	8.6	9.1	350	1990	3000	9.2	8.8	8.5
	20 + 25 + 35 + 35	1.50	1.87	2.62	2.62	1.7	8.6	9.1	350	1990	3000	9.2	8.8	8.5
20 + 35 + 35 + 35	1.38	2.41	2.41	2.41	1.7	8.6	9.1	350	1990	3000	9.2	8.8	8.5	
25 + 25 + 25 + 25	2.15	2.15	2.15	2.15	1.7	8.6	9.1	350	1990	3000	9.2	8.8	8.5	
25 + 25 + 25 + 35	1.95	1.95	1.95	2.74	1.7	8.6	9.1	350	1990	3000	9.2	8.8	8.5	
25 + 25 + 25 + 50	1.72	1.72	1.72	3.44	1.7	8.6	9.1	350	1990	3000	9.2	8.8	8.5	
25 + 25 + 35 + 35	1.79	1.79	2.51	2.51	1.7	8.6	9.1	350	1990	3000	9.2	8.8	8.5	

COMBINATIONS

Indoor unit combination		Cooling capacity (kW)							Power consumption(W)			Standard current(A)		
		Room cooling capacity				Total capacity			Min.	Standard	Max.	220V	230V	240V
		A	B	C	D	Min.	Standard	Max.						
1 room	20	2.00	-	-	-	1.8	2.0	2.7	480	530	950	2.5	2.4	2.3
	25	2.50	-	-	-	1.8	2.5	3.2	480	730	1080	3.5	3.3	3.2
	35	3.50	-	-	-	1.8	3.5	3.7	480	1120	1240	5.2	5.0	4.8
	50	5.00	-	-	-	1.8	5.0	5.8	480	1710	2100	7.9	7.5	7.2
	60	6.00	-	-	-	1.8	6.0	6.7	480	2140	2700	9.8	9.4	9.0
2 room	71	7.10	-	-	-	1.8	7.1	7.2	480	2430	2830	11.2	10.7	10.2
	20 + 20	2.00	2.00	-	-	3.0	4.0	5.8	550	930	1910	4.4	4.2	4.0
	20 + 25	2.00	2.50	-	-	3.0	4.5	6.1	550	1170	2060	5.5	5.2	5.0
	20 + 35	2.00	3.50	-	-	3.0	5.5	6.6	550	1590	2320	7.3	7.0	6.7
	20 + 50	2.03	5.07	-	-	3.0	7.1	7.3	550	2340	2750	10.7	10.3	9.8
	20 + 60	1.78	5.33	-	-	3.0	7.1	7.3	550	2340	2750	10.7	10.3	9.8
	20 + 71	1.56	5.54	-	-	3.0	7.1	7.3	550	2340	2750	10.7	10.3	9.8
	25 + 25	2.50	2.50	-	-	3.0	5.0	6.5	550	1360	2270	6.3	6.0	5.8
	25 + 35	2.46	3.44	-	-	3.0	5.9	6.8	550	1780	2470	8.2	7.8	7.5
	25 + 50	2.37	4.73	-	-	3.0	7.1	7.3	550	2340	2750	10.7	10.3	9.8
	25 + 60	2.09	5.01	-	-	3.0	7.1	7.3	550	2340	2750	10.7	10.3	9.8
	25 + 71	1.85	5.25	-	-	3.0	7.1	7.3	550	2340	2750	10.7	10.3	9.8
	35 + 35	3.55	3.55	-	-	3.0	7.1	7.3	550	2340	2750	10.7	10.3	9.8
	35 + 50	2.92	4.18	-	-	3.0	7.1	7.3	550	2340	2750	10.7	10.3	9.8
	35 + 60	2.62	4.48	-	-	3.0	7.1	7.3	550	2340	2750	10.7	10.3	9.8
	35 + 71	2.34	4.76	-	-	3.0	7.1	7.3	550	2340	2750	10.7	10.3	9.8
	50 + 50	3.55	3.55	-	-	3.0	7.1	7.3	550	2340	2750	10.7	10.3	9.8
50 + 60	3.23	3.87	-	-	3.0	7.1	7.3	550	2340	2750	10.7	10.3	9.8	
50 + 71	2.93	4.17	-	-	3.0	7.1	7.3	550	2340	2750	10.7	10.3	9.8	
60 + 60	3.55	3.55	-	-	3.0	7.1	7.3	550	2340	2750	10.7	10.3	9.8	
3 room	20 + 20 + 20	2.00	2.00	2.00	-	3.7	6.0	7.8	670	1440	2750	6.6	6.4	6.1
	20 + 20 + 25	2.00	2.00	2.50	-	3.7	6.5	7.8	670	1630	2750	7.5	7.2	6.9
	20 + 20 + 35	1.89	1.89	3.31	-	3.7	7.1	7.8	670	1870	2750	8.6	8.2	7.9
	20 + 20 + 50	1.58	1.58	3.94	-	3.7	7.1	7.8	670	1870	2750	8.6	8.2	7.9
	20 + 20 + 60	1.42	1.42	4.26	-	3.7	7.1	7.8	670	1870	2750	8.6	8.2	7.9
	20 + 20 + 71	1.28	1.28	4.54	-	3.7	7.1	7.8	670	1870	2750	8.6	8.2	7.9
	20 + 25 + 25	2.03	2.54	2.54	-	3.7	7.1	7.8	670	1870	2750	8.6	8.2	7.9
	20 + 25 + 35	1.78	2.22	3.11	-	3.7	7.1	7.8	670	1870	2750	8.6	8.2	7.9
	20 + 25 + 50	1.49	1.87	3.74	-	3.7	7.1	7.8	670	1870	2750	8.6	8.2	7.9
	20 + 25 + 60	1.35	1.69	4.06	-	3.7	7.1	7.8	670	1870	2750	8.6	8.2	7.9
	20 + 25 + 71	1.22	1.53	4.35	-	3.7	7.1	7.8	670	1870	2750	8.6	8.2	7.9
	20 + 35 + 35	1.58	2.76	2.76	-	3.7	7.1	7.8	670	1870	2750	8.6	8.2	7.9
	20 + 35 + 50	1.35	2.37	3.38	-	3.7	7.1	7.8	670	1870	2750	8.6	8.2	7.9
	20 + 35 + 60	1.23	2.16	3.70	-	3.7	7.1	7.8	670	1870	2750	8.6	8.2	7.9
	20 + 35 + 71	1.13	1.97	4.00	-	3.7	7.1	7.8	670	1870	2750	8.6	8.2	7.9
	20 + 50 + 50	1.18	2.96	2.96	-	3.7	7.1	7.8	670	1870	2750	8.6	8.2	7.9
	25 + 25 + 25	2.37	2.37	2.37	-	3.7	7.1	7.8	670	1870	2750	8.6	8.2	7.9
	25 + 25 + 35	2.09	2.09	2.92	-	3.7	7.1	7.8	670	1870	2750	8.6	8.2	7.9
	25 + 25 + 50	1.78	1.78	3.55	-	3.7	7.1	7.8	670	1870	2750	8.6	8.2	7.9
	25 + 25 + 60	1.61	1.61	3.87	-	3.7	7.1	7.8	670	1870	2750	8.6	8.2	7.9
	25 + 25 + 71	1.47	1.47	4.17	-	3.7	7.1	7.8	670	1870	2750	8.6	8.2	7.9
25 + 35 + 35	1.87	2.62	2.62	-	3.7	7.1	7.8	670	1870	2750	8.6	8.2	7.9	
25 + 35 + 50	1.61	2.26	3.23	-	3.7	7.1	7.8	670	1870	2750	8.6	8.2	7.9	
25 + 35 + 60	1.48	2.07	3.55	-	3.7	7.1	7.8	670	1870	2750	8.6	8.2	7.9	
25 + 50 + 50	1.42	2.84	2.84	-	3.7	7.1	7.8	670	1870	2750	8.6	8.2	7.9	
35 + 35 + 35	2.37	2.37	2.37	-	3.7	7.1	7.8	670	1870	2750	8.6	8.2	7.9	
35 + 35 + 50	2.07	2.07	2.96	-	3.7	7.1	7.8	670	1870	2750	8.6	8.2	7.9	
4 room	20 + 20 + 20 + 20	1.78	1.78	1.78	1.78	4.4	7.1	8.3	890	1780	2750	8.2	7.8	7.5
	20 + 20 + 20 + 25	1.67	1.67	1.67	2.09	4.4	7.1	8.3	890	1780	2750	8.2	7.8	7.5
	20 + 20 + 20 + 35	1.49	1.49	1.49	2.62	4.4	7.1	8.3	890	1780	2750	8.2	7.8	7.5
	20 + 20 + 20 + 50	1.29	1.29	1.29	3.23	4.4	7.1	8.3	890	1780	2750	8.2	7.8	7.5
	20 + 20 + 20 + 60	1.18	1.18	1.18	3.55	4.4	7.1	8.3	890	1780	2750	8.2	7.8	7.5
	20 + 20 + 25 + 25	1.58	1.58	1.97	1.97	4.4	7.1	8.3	890	1780	2750	8.2	7.8	7.5
	20 + 20 + 25 + 35	1.42	1.42	1.78	2.49	4.4	7.1	8.3	890	1780	2750	8.2	7.8	7.5
	20 + 20 + 25 + 50	1.23	1.23	1.54	3.09	4.4	7.1	8.3	890	1780	2750	8.2	7.8	7.5
	20 + 20 + 25 + 60	1.14	1.14	1.42	3.41	4.4	7.1	8.3	890	1780	2750	8.2	7.8	7.5
	20 + 20 + 35 + 35	1.29	1.29	2.26	2.26	4.4	7.1	8.3	890	1780	2750	8.2	7.8	7.5
	20 + 20 + 35 + 50	1.14	1.14	1.99	2.84	4.4	7.1	8.3	890	1780	2750	8.2	7.8	7.5
	20 + 25 + 25 + 25	1.49	1.87	1.87	1.87	4.4	7.1	8.3	890	1780	2750	8.2	7.8	7.5
	20 + 25 + 25 + 35	1.35	1.69	1.69	2.37	4.4	7.1	8.3	890	1780	2750	8.2	7.8	7.5
	20 + 25 + 25 + 50	1.18	1.48	1.48	2.96	4.4	7.1	8.3	890	1780	2750	8.2	7.8	7.5
	20 + 25 + 35 + 35	1.23	1.54	2.16	2.16	4.4	7.1	8.3	890	1780	2750	8.2	7.8	7.5
	20 + 35 + 35 + 35	1.14	1.99	1.99	1.99	4.4	7.1	8.3	890	1780	2750	8.2	7.8	7.5
	25 + 25 + 25 + 25	1.78	1.78	1.78	1.78	4.4	7.1	8.3	890	1780	2750	8.2	7.8	7.5
25 + 25 + 25 + 35	1.61	1.61	1.61	2.26	4.4	7.1	8.3	890	1780	2750	8.2	7.8	7.5	
25 + 25 + 25 + 50	1.42	1.42	1.42	2.84	4.4	7.1	8.3	890	1780	2750	8.2	7.8	7.5	
25 + 25 + 35 + 35	1.48	1.48	2.07	2.07	4.4	7.1	8.3	890	1780	2750	8.2	7.8	7.5	



MULTI-SPLIT SYSTEM

SCM80ZS-W Table of Indoor unit combination only with SRK-ZSX type

Indoor unit combination		Heating capacity (kW)						Power consumption(W)			Standard current(A)			
		Room heating capacity				Total capacity		Min.	Standard	Max.	220V	230V	240V	
		A	B	C	D	Min.	Standard							Max.
1 room	20	3.00	-	-	-	1.1	3.0	3.7	390	840	1330	4.0	3.8	3.6
	25	3.40	-	-	-	1.1	3.4	4.2	390	1000	1510	4.7	4.5	4.3
	35	4.50	-	-	-	1.1	4.5	5.0	390	1330	1790	6.2	5.9	5.7
	50	5.80	-	-	-	1.1	5.8	6.5	390	1780	2310	8.3	7.9	7.6
	60	6.80	-	-	-	1.1	6.8	7.5	390	2100	2660	9.7	9.3	8.9
2 room	20 + 20	2.70	2.70	-	-	1.5	5.4	7.4	350	1280	1870	6.0	5.7	5.5
	20 + 25	2.62	3.28	-	-	1.5	5.9	7.7	350	1410	2130	6.6	6.3	6.0
	20 + 35	2.51	4.39	-	-	1.5	6.9	8.3	350	1680	2650	7.8	7.5	7.1
	20 + 50	2.46	6.14	-	-	1.5	8.6	9.5	350	2100	3120	9.7	9.3	8.9
	20 + 60	2.33	6.98	-	-	1.5	9.3	9.5	350	2300	3120	10.7	10.2	9.8
	25 + 25	3.20	3.20	-	-	1.5	6.4	8.1	350	1540	2480	7.1	6.8	6.5
	25 + 35	3.08	4.32	-	-	1.5	7.4	8.6	350	1810	2910	8.4	8.0	7.7
	25 + 50	2.97	5.93	-	-	1.5	8.9	9.5	350	2180	3120	10.1	9.7	9.3
	25 + 60	2.74	6.56	-	-	1.5	9.3	9.5	350	2300	3120	10.7	10.2	9.8
	35 + 35	4.30	4.30	-	-	1.5	8.6	9.5	350	2100	3120	9.7	9.3	8.9
	35 + 50	3.83	5.47	-	-	1.5	9.3	9.5	350	2300	3120	10.7	10.2	9.8
	35 + 60	3.43	5.87	-	-	1.5	9.3	9.5	350	2300	3120	10.7	10.2	9.8
	50 + 50	4.65	4.65	-	-	1.5	9.3	9.5	350	2300	3120	10.7	10.2	9.8
	50 + 60	4.23	5.07	-	-	1.5	9.3	9.5	350	2300	3120	10.7	10.2	9.8
	60 + 60	4.65	4.65	-	-	1.5	9.3	9.5	350	2300	3120	10.7	10.2	9.8
3 room	20 + 20 + 20	2.57	2.57	2.57	-	1.6	7.7	9.6	370	1830	3120	8.5	8.1	7.8
	20 + 20 + 25	2.46	2.46	3.08	-	1.6	8.0	9.6	370	1930	3120	9.0	8.6	8.2
	20 + 20 + 35	2.37	2.37	4.15	-	1.6	8.9	9.6	370	2140	3120	9.9	9.5	9.1
	20 + 20 + 50	2.07	2.07	5.17	-	1.6	9.3	9.6	370	2250	3120	10.4	10.0	9.6
	20 + 20 + 60	1.86	1.86	5.58	-	1.6	9.3	9.6	370	2250	3120	10.4	10.0	9.6
	20 + 25 + 25	2.46	3.07	3.07	-	1.6	8.6	9.6	370	2060	3120	9.6	9.1	8.8
	20 + 25 + 35	2.33	2.91	4.07	-	1.6	9.3	9.6	370	2250	3120	10.4	10.0	9.6
	20 + 25 + 50	1.96	2.45	4.89	-	1.6	9.3	9.6	370	2250	3120	10.4	10.0	9.6
	20 + 25 + 60	1.77	2.21	5.31	-	1.6	9.3	9.6	370	2250	3120	10.4	10.0	9.6
	20 + 35 + 35	2.07	3.62	3.62	-	1.6	9.3	9.6	370	2250	3120	10.4	10.0	9.6
	20 + 35 + 50	1.77	3.10	4.43	-	1.6	9.3	9.6	370	2250	3120	10.4	10.0	9.6
	20 + 35 + 60	1.62	2.83	4.85	-	1.6	9.3	9.6	370	2250	3120	10.4	10.0	9.6
	20 + 50 + 50	1.55	3.88	3.88	-	1.6	9.3	9.6	370	2250	3120	10.4	10.0	9.6
	20 + 50 + 60	1.43	3.58	4.29	-	1.6	9.3	9.6	370	2250	3120	10.4	10.0	9.6
	25 + 25 + 25	2.97	2.97	2.97	-	1.6	8.9	9.6	370	2140	3120	9.9	9.5	9.1
	25 + 25 + 35	2.74	2.74	3.83	-	1.6	9.3	9.6	370	2250	3120	10.4	10.0	9.6
	25 + 25 + 50	2.33	2.33	4.65	-	1.6	9.3	9.6	370	2250	3120	10.4	10.0	9.6
	25 + 25 + 60	2.11	2.11	5.07	-	1.6	9.3	9.6	370	2250	3120	10.4	10.0	9.6
	25 + 35 + 35	2.45	3.43	3.43	-	1.6	9.3	9.6	370	2250	3120	10.4	10.0	9.6
	25 + 35 + 50	2.11	2.96	4.23	-	1.6	9.3	9.6	370	2250	3120	10.4	10.0	9.6
	25 + 35 + 60	1.94	2.71	4.65	-	1.6	9.3	9.6	370	2250	3120	10.4	10.0	9.6
	25 + 50 + 50	1.86	3.72	3.72	-	1.6	9.3	9.6	370	2250	3120	10.4	10.0	9.6
	25 + 50 + 60	1.72	3.44	4.13	-	1.6	9.3	9.6	370	2250	3120	10.4	10.0	9.6
	35 + 35 + 35	3.10	3.10	3.10	-	1.6	9.3	9.6	370	2250	3120	10.4	10.0	9.6
	35 + 35 + 50	2.71	2.71	3.88	-	1.6	9.3	9.6	370	2250	3120	10.4	10.0	9.6
35 + 35 + 60	2.50	2.50	4.29	-	1.6	9.3	9.6	370	2250	3120	10.4	10.0	9.6	
35 + 50 + 50	2.41	3.44	3.44	-	1.6	9.3	9.6	370	2250	3120	10.4	10.0	9.6	
4 room	20 + 20 + 20 + 20	2.33	2.33	2.33	2.33	1.7	9.3	9.8	350	1950	3120	9.0	8.6	8.2
	20 + 20 + 20 + 25	2.19	2.19	2.19	2.74	1.7	9.3	9.8	350	1950	3120	9.0	8.6	8.2
	20 + 20 + 20 + 35	1.96	1.96	1.96	3.43	1.7	9.3	9.8	350	1950	3120	9.0	8.6	8.2
	20 + 20 + 20 + 50	1.69	1.69	1.69	4.23	1.7	9.3	9.8	350	1950	3120	9.0	8.6	8.2
	20 + 20 + 20 + 60	1.55	1.55	1.55	4.65	1.7	9.3	9.8	350	1950	3120	9.0	8.6	8.2
	20 + 20 + 25 + 25	2.07	2.07	2.58	2.58	1.7	9.3	9.8	350	1950	3120	9.0	8.6	8.2
	20 + 20 + 25 + 35	1.86	1.86	2.33	3.26	1.7	9.3	9.8	350	1950	3120	9.0	8.6	8.2
	20 + 20 + 25 + 50	1.62	1.62	2.02	4.04	1.7	9.3	9.8	350	1950	3120	9.0	8.6	8.2
	20 + 20 + 25 + 60	1.49	1.49	1.86	4.46	1.7	9.3	9.8	350	1950	3120	9.0	8.6	8.2
	20 + 20 + 35 + 35	1.69	1.69	2.96	2.96	1.7	9.3	9.8	350	1950	3120	9.0	8.6	8.2
	20 + 20 + 35 + 50	1.49	1.49	2.60	3.72	1.7	9.3	9.8	350	1950	3120	9.0	8.6	8.2
	20 + 20 + 35 + 60	1.38	1.38	2.41	4.13	1.7	9.3	9.8	350	1950	3120	9.0	8.6	8.2
	20 + 25 + 25 + 25	1.96	2.45	2.45	2.45	1.7	9.3	9.8	350	1950	3120	9.0	8.6	8.2
	20 + 25 + 25 + 35	1.77	2.21	2.21	3.10	1.7	9.3	9.8	350	1950	3120	9.0	8.6	8.2
	20 + 25 + 25 + 50	1.55	1.94	1.94	3.88	1.7	9.3	9.8	350	1950	3120	9.0	8.6	8.2
	20 + 25 + 25 + 60	1.43	1.79	1.79	4.29	1.7	9.3	9.8	350	1950	3120	9.0	8.6	8.2
	20 + 25 + 35 + 35	1.62	2.02	2.83	2.83	1.7	9.3	9.8	350	1950	3120	9.0	8.6	8.2
	20 + 25 + 35 + 50	1.43	1.79	2.50	3.58	1.7	9.3	9.8	350	1950	3120	9.0	8.6	8.2
	20 + 35 + 35 + 35	1.49	2.60	2.60	2.60	1.7	9.3	9.8	350	1950	3120	9.0	8.6	8.2
	25 + 25 + 25 + 25	2.33	2.33	2.33	2.33	1.7	9.3	9.8	350	1950	3120	9.0	8.6	8.2
	25 + 25 + 25 + 35	2.11	2.11	2.11	2.96	1.7	9.3	9.8	350	1950	3120	9.0	8.6	8.2
	25 + 25 + 25 + 50	1.86	1.86	1.86	3.72	1.7	9.3	9.8	350	1950	3120	9.0	8.6	8.2
	25 + 25 + 25 + 60	1.72	1.72	1.72	4.13	1.7	9.3	9.8	350	1950	3120	9.0	8.6	8.2
	25 + 25 + 35 + 35	1.94	1.94	2.71	2.71	1.7	9.3	9.8	350	1950	3120	9.0	8.6	8.2
	25 + 25 + 35 + 50	1.72	1.72	2.41	3.44	1.7	9.3	9.8	350	1950	3120	9.0	8.6	8.2
25 + 35 + 35 + 35	1.79	2.50	2.50	2.50	1.7	9.3	9.8	350	1950	3120	9.0	8.6	8.2	

COMBINATIONS

Indoor unit combination		Cooling capacity (kW)							Power consumption(W)			Standard current(A)			
		Room cooling capacity				Total capacity			Min.	Standard	Max.	220V	230V	240V	
		A	B	C	D	Min.	Standard	Max.							
Cooling operation	1 room	20	2.00	-	-	-	1.8	2.0	2.8	480	500	950	2.4	2.3	2.2
		25	2.50	-	-	-	1.8	2.5	3.4	480	680	1080	3.2	3.1	3.0
		35	3.50	-	-	-	1.8	3.5	3.9	480	1010	1240	4.7	4.5	4.3
		50	5.00	-	-	-	1.8	5.0	6.1	480	1530	2100	7.0	6.7	6.4
		60	6.00	-	-	-	1.8	6.0	7.0	480	1880	2700	8.6	8.3	7.9
	2 room	20 + 20	2.00	2.00	-	-	3.0	4.0	6.1	550	840	1910	4.0	3.8	3.6
		20 + 25	2.00	2.50	-	-	3.0	4.5	6.4	550	990	2060	4.6	4.4	4.3
		20 + 35	2.00	3.50	-	-	3.0	5.5	6.9	550	1320	2320	6.1	5.8	5.6
		20 + 50	2.03	5.07	-	-	3.0	7.1	8.5	550	1970	2830	9.0	8.7	8.3
		20 + 60	2.00	6.00	-	-	3.0	8.0	8.5	550	2420	2830	11.1	10.6	10.2
		25 + 25	2.50	2.50	-	-	3.0	5.0	6.8	550	1150	2270	5.4	5.1	4.9
		25 + 35	2.46	3.44	-	-	3.0	5.9	7.2	550	1560	2470	7.2	6.9	6.6
		25 + 50	2.47	4.93	-	-	3.0	7.4	8.5	550	2090	2830	9.6	9.2	8.8
		25 + 60	2.35	5.65	-	-	3.0	8.0	8.5	550	2420	2830	11.1	10.6	10.2
		35 + 35	3.55	3.55	-	-	3.0	7.1	8.5	550	1970	2830	9.0	8.7	8.3
35 + 50		3.29	4.71	-	-	3.0	8.0	8.5	550	2420	2830	11.1	10.6	10.2	
35 + 60		2.95	5.05	-	-	3.0	8.0	8.5	550	2420	2830	11.1	10.6	10.2	
50 + 50		4.00	4.00	-	-	3.0	8.0	8.5	550	2420	2830	11.1	10.6	10.2	
50 + 60		3.64	4.36	-	-	3.0	8.0	8.5	550	2420	2830	11.1	10.6	10.2	
60 + 60		4.00	4.00	-	-	3.0	8.0	8.5	550	2420	2830	11.1	10.6	10.2	
3 room	20 + 20 + 20	2.00	2.00	2.00	-	3.7	6.0	8.8	670	1240	2830	5.8	5.5	5.3	
	20 + 20 + 25	2.00	2.00	2.50	-	3.7	6.5	8.8	670	1390	2830	6.4	6.1	5.9	
	20 + 20 + 35	2.00	2.00	3.50	-	3.7	7.5	8.8	670	1720	2830	7.9	7.6	7.2	
	20 + 20 + 50	1.78	1.78	4.44	-	3.7	8.0	8.8	670	1910	2830	8.8	8.4	8.0	
	20 + 20 + 60	1.60	1.60	4.80	-	3.7	8.0	8.8	670	1910	2830	8.8	8.4	8.0	
	20 + 25 + 25	2.03	2.54	2.54	-	3.7	7.1	8.8	670	1520	2830	7.0	6.7	6.4	
	20 + 25 + 35	2.00	2.50	3.50	-	3.7	8.0	8.8	670	1910	2830	8.8	8.4	8.0	
	20 + 25 + 50	1.68	2.11	4.21	-	3.7	8.0	8.8	670	1910	2830	8.8	8.4	8.0	
	20 + 25 + 60	1.52	1.90	4.57	-	3.7	8.0	8.8	670	1910	2830	8.8	8.4	8.0	
	20 + 35 + 35	1.78	3.11	3.11	-	3.7	8.0	8.8	670	1910	2830	8.8	8.4	8.0	
	20 + 35 + 50	1.52	2.67	3.81	-	3.7	8.0	8.8	670	1910	2830	8.8	8.4	8.0	
	20 + 35 + 60	1.39	2.43	4.17	-	3.7	8.0	8.8	670	1910	2830	8.8	8.4	8.0	
	20 + 50 + 50	1.33	3.33	3.33	-	3.7	8.0	8.8	670	1910	2830	8.8	8.4	8.0	
	20 + 50 + 60	1.23	3.08	3.69	-	3.7	8.0	8.8	670	1910	2830	8.8	8.4	8.0	
	25 + 25 + 25	2.50	2.50	2.50	-	3.7	7.5	8.8	670	1720	2830	7.9	7.6	7.2	
	25 + 25 + 35	2.35	2.35	3.29	-	3.7	8.0	8.8	670	1910	2830	8.8	8.4	8.0	
	25 + 25 + 50	2.00	2.00	4.00	-	3.7	8.0	8.8	670	1910	2830	8.8	8.4	8.0	
	25 + 25 + 60	1.82	1.82	4.36	-	3.7	8.0	8.8	670	1910	2830	8.8	8.4	8.0	
	25 + 35 + 35	2.11	2.95	2.95	-	3.7	8.0	8.8	670	1910	2830	8.8	8.4	8.0	
	25 + 35 + 50	1.82	2.55	3.64	-	3.7	8.0	8.8	670	1910	2830	8.8	8.4	8.0	
	25 + 35 + 60	1.67	2.33	4.00	-	3.7	8.0	8.8	670	1910	2830	8.8	8.4	8.0	
	25 + 50 + 50	1.60	3.20	3.20	-	3.7	8.0	8.8	670	1910	2830	8.8	8.4	8.0	
	25 + 50 + 60	1.48	2.96	3.56	-	3.7	8.0	8.8	670	1910	2830	8.8	8.4	8.0	
	35 + 35 + 35	2.67	2.67	2.67	-	3.7	8.0	8.8	670	1910	2830	8.8	8.4	8.0	
	35 + 35 + 50	2.33	2.33	3.33	-	3.7	8.0	8.8	670	1910	2830	8.8	8.4	8.0	
35 + 35 + 60	2.15	2.15	3.69	-	3.7	8.0	8.8	670	1910	2830	8.8	8.4	8.0		
35 + 50 + 50	2.07	2.96	2.96	-	3.7	8.0	8.8	670	1910	2830	8.8	8.4	8.0		
4 room	20 + 20 + 20 + 20	2.00	2.00	2.00	2.00	4.4	8.0	9.2	890	1700	2830	7.8	7.5	7.2	
	20 + 20 + 20 + 25	1.88	1.88	1.88	2.35	4.4	8.0	9.2	890	1700	2830	7.8	7.5	7.2	
	20 + 20 + 20 + 35	1.68	1.68	1.68	2.95	4.4	8.0	9.2	890	1700	2830	7.8	7.5	7.2	
	20 + 20 + 20 + 50	1.45	1.45	1.45	3.64	4.4	8.0	9.2	890	1700	2830	7.8	7.5	7.2	
	20 + 20 + 20 + 60	1.33	1.33	1.33	4.00	4.4	8.0	9.2	890	1700	2830	7.8	7.5	7.2	
	20 + 20 + 25 + 25	1.78	1.78	2.22	2.22	4.4	8.0	9.2	890	1700	2830	7.8	7.5	7.2	
	20 + 20 + 25 + 35	1.60	1.60	2.00	2.80	4.4	8.0	9.2	890	1700	2830	7.8	7.5	7.2	
	20 + 20 + 25 + 50	1.39	1.39	1.74	3.48	4.4	8.0	9.2	890	1700	2830	7.8	7.5	7.2	
	20 + 20 + 25 + 60	1.28	1.28	1.60	3.84	4.4	8.0	9.2	890	1700	2830	7.8	7.5	7.2	
	20 + 20 + 35 + 35	1.45	1.45	2.55	2.55	4.4	8.0	9.2	890	1700	2830	7.8	7.5	7.2	
	20 + 20 + 35 + 50	1.28	1.28	2.24	3.20	4.4	8.0	9.2	890	1700	2830	7.8	7.5	7.2	
	20 + 20 + 35 + 60	1.19	1.19	2.07	3.56	4.4	8.0	9.2	890	1700	2830	7.8	7.5	7.2	
	20 + 25 + 25 + 25	1.68	2.11	2.11	2.11	4.4	8.0	9.2	890	1700	2830	7.8	7.5	7.2	
	20 + 25 + 25 + 35	1.52	1.90	1.90	2.67	4.4	8.0	9.2	890	1700	2830	7.8	7.5	7.2	
	20 + 25 + 25 + 50	1.33	1.67	1.67	3.33	4.4	8.0	9.2	890	1700	2830	7.8	7.5	7.2	
	20 + 25 + 25 + 60	1.23	1.54	1.54	3.69	4.4	8.0	9.2	890	1700	2830	7.8	7.5	7.2	
	20 + 25 + 35 + 35	1.39	1.74	2.43	2.43	4.4	8.0	9.2	890	1700	2830	7.8	7.5	7.2	
	20 + 25 + 35 + 50	1.23	1.54	2.15	3.08	4.4	8.0	9.2	890	1700	2830	7.8	7.5	7.2	
	20 + 35 + 35 + 35	1.28	2.24	2.24	2.24	4.4	8.0	9.2	890	1700	2830	7.8	7.5	7.2	
	25 + 25 + 25 + 25	2.00	2.00	2.00	2.00	4.4	8.0	9.2	890	1700	2830	7.8	7.5	7.2	
	25 + 25 + 25 + 35	1.82	1.82	1.82	2.55	4.4	8.0	9.2	890	1700	2830	7.8	7.5	7.2	
	25 + 25 + 25 + 50	1.60	1.60	1.60	3.20	4.4	8.0	9.2	890	1700	2830	7.8	7.5	7.2	
	25 + 25 + 25 + 60	1.48	1.48	1.48	3.56	4.4	8.0	9.2	890	1700	2830	7.8	7.5	7.2	
	25 + 25 + 35 + 35	1.67	1.67	2.33	2.33	4.4	8.0	9.2	890	1700	2830	7.8	7.5	7.2	
	25 + 25 + 35 + 50	1.48	1.48	2.07	2.96	4.4	8.0	9.2	890	1700	2830	7.8	7.5	7.2	
25 + 35 + 35 + 35	1.54	2.15	2.15	2.15	4.4	8.0	9.2	890	1700	2830	7.8	7.5	7.2		



MULTI-SPLIT SYSTEM

SCM80ZS-W Table of Indoor unit combination with other indoor unit

Indoor unit combination		Heating capacity (kW)							Power consumption(W)			Standard current(A)		
		Room heating capacity				Total capacity			Min.	Standard	Max.	220V	230V	240V
		A	B	C	D	Min.	Standard	Max.						
1 room	20	3.00	-	-	-	1.1	3.0	3.5	390	1060	1330	5.0	4.8	4.6
	25	3.40	-	-	-	1.1	3.4	4.0	390	1220	1510	5.7	5.5	5.2
	35	4.50	-	-	-	1.1	4.5	4.8	390	1510	1790	7.0	6.7	6.4
	50	5.80	-	-	-	1.1	5.8	6.2	390	1950	2310	9.0	8.7	8.3
	60	6.80	-	-	-	1.1	6.8	7.1	390	2240	2660	10.4	9.9	9.5
	71	8.00	-	-	-	1.1	8.0	8.1	390	2740	3120	12.7	12.2	11.6
2 room	20 + 20	2.70	2.70	-	-	1.5	5.4	7.0	350	1370	1870	6.4	6.1	5.9
	20 + 25	2.62	3.28	-	-	1.5	5.9	7.3	350	1560	2130	7.3	6.9	6.7
	20 + 35	2.51	4.39	-	-	1.5	6.9	7.9	350	1930	2650	9.0	8.6	8.2
	20 + 50	2.46	6.14	-	-	1.5	8.6	9.4	350	2460	3120	11.4	10.9	10.5
	20 + 60	2.33	6.98	-	-	1.5	9.3	9.4	350	2650	3120	12.3	11.8	11.3
	20 + 71	2.04	7.26	-	-	1.5	9.3	9.4	350	2650	3120	12.3	11.8	11.3
	25 + 25	3.20	3.20	-	-	1.5	6.4	7.7	350	1740	2480	8.1	7.7	7.4
	25 + 35	3.08	4.32	-	-	1.5	7.4	8.2	350	2130	2910	9.9	9.4	9.1
	25 + 50	2.97	5.93	-	-	1.5	8.9	9.4	350	2540	3120	11.8	11.3	10.8
	25 + 60	2.74	6.56	-	-	1.5	9.3	9.4	350	2650	3120	12.3	11.8	11.3
	25 + 71	2.42	6.88	-	-	1.5	9.3	9.4	350	2650	3120	12.3	11.8	11.3
	35 + 35	4.30	4.30	-	-	1.5	8.6	9.4	350	2460	3120	11.4	10.9	10.5
	35 + 50	3.83	5.47	-	-	1.5	9.3	9.4	350	2650	3120	12.3	11.8	11.3
	35 + 60	3.43	5.87	-	-	1.5	9.3	9.4	350	2650	3120	12.3	11.8	11.3
	35 + 71	3.07	6.23	-	-	1.5	9.3	9.4	350	2650	3120	12.3	11.8	11.3
	50 + 50	4.65	4.65	-	-	1.5	9.3	9.4	350	2650	3120	12.3	11.8	11.3
	50 + 60	4.23	5.07	-	-	1.5	9.3	9.4	350	2650	3120	12.3	11.8	11.3
	50 + 71	3.84	5.46	-	-	1.5	9.3	9.4	350	2650	3120	12.3	11.8	11.3
	60 + 60	4.65	4.65	-	-	1.5	9.3	9.4	350	2650	3120	12.3	11.8	11.3
	60 + 71	4.26	5.04	-	-	1.5	9.3	9.4	350	2650	3120	12.3	11.8	11.3
3 room	20 + 20 + 20	2.57	2.57	2.57	-	1.6	7.7	9.5	370	1870	3120	8.7	8.3	8.0
	20 + 20 + 25	2.46	2.46	3.08	-	1.6	8.0	9.5	370	1970	3120	9.1	8.7	8.4
	20 + 20 + 35	2.37	2.37	4.15	-	1.6	8.9	9.5	370	2490	3120	11.5	11.0	10.6
	20 + 20 + 50	2.07	2.07	5.17	-	1.6	9.3	9.5	370	2600	3120	12.1	11.5	11.1
	20 + 20 + 60	1.86	1.86	5.58	-	1.6	9.3	9.5	370	2600	3120	12.1	11.5	11.1
	20 + 20 + 71	1.68	1.68	5.95	-	1.6	9.3	9.5	370	2600	3120	12.1	11.5	11.1
	20 + 25 + 25	2.46	3.07	3.07	-	1.6	8.6	9.5	370	2410	3120	11.2	10.7	10.2
	20 + 25 + 35	2.33	2.91	4.07	-	1.6	9.3	9.5	370	2600	3120	12.1	11.5	11.1
	20 + 25 + 50	1.96	2.45	4.89	-	1.6	9.3	9.5	370	2600	3120	12.1	11.5	11.1
	20 + 25 + 60	1.77	2.21	5.31	-	1.6	9.3	9.5	370	2600	3120	12.1	11.5	11.1
	20 + 25 + 71	1.60	2.00	5.69	-	1.6	9.3	9.5	370	2600	3120	12.1	11.5	11.1
	20 + 35 + 35	2.07	3.62	3.62	-	1.6	9.3	9.5	370	2600	3120	12.1	11.5	11.1
	20 + 35 + 50	1.77	3.10	4.43	-	1.6	9.3	9.5	370	2600	3120	12.1	11.5	11.1
	20 + 35 + 60	1.62	2.83	4.85	-	1.6	9.3	9.5	370	2600	3120	12.1	11.5	11.1
	20 + 35 + 71	1.48	2.58	5.24	-	1.6	9.3	9.5	370	2600	3120	12.1	11.5	11.1
	20 + 50 + 50	1.55	3.88	3.88	-	1.6	9.3	9.5	370	2600	3120	12.1	11.5	11.1
	20 + 50 + 60	1.43	3.58	4.29	-	1.6	9.3	9.5	370	2600	3120	12.1	11.5	11.1
	25 + 25 + 25	2.97	2.97	2.97	-	1.6	8.9	9.5	370	2490	3120	11.5	11.0	10.6
	25 + 25 + 35	2.74	2.74	3.83	-	1.6	9.3	9.5	370	2600	3120	12.1	11.5	11.1
	25 + 25 + 50	2.33	2.33	4.65	-	1.6	9.3	9.5	370	2600	3120	12.1	11.5	11.1
	25 + 25 + 60	2.11	2.11	5.07	-	1.6	9.3	9.5	370	2600	3120	12.1	11.5	11.1
	25 + 25 + 71	1.92	1.92	5.46	-	1.6	9.3	9.5	370	2600	3120	12.1	11.5	11.1
	25 + 35 + 35	2.45	3.43	3.43	-	1.6	9.3	9.5	370	2600	3120	12.1	11.5	11.1
	25 + 35 + 50	2.11	2.96	4.23	-	1.6	9.3	9.5	370	2600	3120	12.1	11.5	11.1
	25 + 35 + 60	1.94	2.71	4.65	-	1.6	9.3	9.5	370	2600	3120	12.1	11.5	11.1
	25 + 35 + 71	1.77	2.48	5.04	-	1.6	9.3	9.5	370	2600	3120	12.1	11.5	11.1
	25 + 50 + 50	1.86	3.72	3.72	-	1.6	9.3	9.5	370	2600	3120	12.1	11.5	11.1
	25 + 50 + 60	1.72	3.44	4.13	-	1.6	9.3	9.5	370	2600	3120	12.1	11.5	11.1
	35 + 35 + 35	3.10	3.10	3.10	-	1.6	9.3	9.5	370	2600	3120	12.1	11.5	11.1
	35 + 35 + 50	2.71	2.71	3.88	-	1.6	9.3	9.5	370	2600	3120	12.1	11.5	11.1
35 + 35 + 60	2.50	2.50	4.29	-	1.6	9.3	9.5	370	2600	3120	12.1	11.5	11.1	
35 + 50 + 50	2.41	3.44	3.44	-	1.6	9.3	9.5	370	2600	3120	12.1	11.5	11.1	
4 room	20 + 20 + 20 + 20	2.33	2.33	2.33	2.33	1.7	9.3	9.6	350	2170	3120	10.1	9.6	9.2
	20 + 20 + 20 + 25	2.19	2.19	2.19	2.74	1.7	9.3	9.6	350	2170	3120	10.1	9.6	9.2
	20 + 20 + 20 + 35	1.96	1.96	1.96	3.43	1.7	9.3	9.6	350	2170	3120	10.1	9.6	9.2
	20 + 20 + 20 + 50	1.69	1.69	1.69	4.23	1.7	9.3	9.6	350	2170	3120	10.1	9.6	9.2
	20 + 20 + 20 + 60	1.55	1.55	1.55	4.65	1.7	9.3	9.6	350	2170	3120	10.1	9.6	9.2
	20 + 20 + 25 + 25	2.07	2.07	2.58	2.58	1.7	9.3	9.6	350	2170	3120	10.1	9.6	9.2
	20 + 20 + 25 + 35	1.86	1.86	2.33	3.26	1.7	9.3	9.6	350	2170	3120	10.1	9.6	9.2
	20 + 20 + 25 + 50	1.62	1.62	2.02	4.04	1.7	9.3	9.6	350	2170	3120	10.1	9.6	9.2
	20 + 20 + 25 + 60	1.49	1.49	1.86	4.46	1.7	9.3	9.6	350	2170	3120	10.1	9.6	9.2
	20 + 20 + 35 + 35	1.69	1.69	2.96	2.96	1.7	9.3	9.6	350	2170	3120	10.1	9.6	9.2
	20 + 20 + 35 + 50	1.49	1.49	2.60	3.72	1.7	9.3	9.6	350	2170	3120	10.1	9.6	9.2
	20 + 20 + 35 + 60	1.38	1.38	2.41	4.13	1.7	9.3	9.6	350	2170	3120	10.1	9.6	9.2
	20 + 25 + 25 + 25	1.96	2.45	2.45	2.45	1.7	9.3	9.6	350	2170	3120	10.1	9.6	9.2
	20 + 25 + 25 + 35	1.77	2.21	2.21	3.10	1.7	9.3	9.6	350	2170	3120	10.1	9.6	9.2
	20 + 25 + 25 + 50	1.55	1.94	1.94	3.88	1.7	9.3	9.6	350	2170	3120	10.1	9.6	9.2
	20 + 25 + 25 + 60	1.43	1.79	1.79	4.29	1.7	9.3	9.6	350	2170	3120	10.1	9.6	9.2
	20 + 25 + 35 + 35	1.62	2.02	2.83	2.83	1.7	9.3	9.6	350	2170	3120	10.1	9.6	9.2
	20 + 25 + 35 + 50	1.43	1.79	2.50	3.58	1.7	9.3	9.6	350	2170	3120	10.1	9.6	9.2
	20 + 35 + 35 + 35	1.49	2.60	2.60	2.60	1.7	9.3	9.6	350	2170	3120	10.1	9.6	9.2
	25 + 25 + 25 + 25	2.33	2.33	2.33	2.33	1.7	9.3	9.6	350	2170	3120	10.1	9.6	9.2
	25 + 25 + 25 + 35	2.11	2.11	2.11	2.96	1.7	9.3	9.6	350	2170	3120	10.1	9.6	9.2
	25 + 25 + 25 + 50	1.86	1.86	1.86	3.72	1.7	9.3	9.6	350	2170	3120	10.1	9.6	9.2
	25 + 25 + 25 + 60	1.72	1.72	1.72	4.13	1.7	9.3	9.6	350	2170	3120	10.1	9.6	9.2
	25 + 25 + 35 + 35	1.94	1.94	2.71	2.71	1.7	9.3	9.6	350	2170	3120	10.1	9.6	9.2
25 + 25 + 35 + 50	1.72	1.72	2.41	3.44	1.7	9.3	9.6	350	2170	3120	10.1	9.6	9.2	
25 + 35 + 35 + 35	1.79	2.50												

COMBINATIONS

Indoor unit combination		Cooling capacity (kW)							Power consumption(W)			Standard current(A)		
		Room cooling capacity				Total capacity			Min.	Standard	Max.	220V	230V	240V
		A	B	C	D	Min.	Standard	Max.						
1 room	20	2.00	-	-	-	1.8	2.0	2.7	480	530	950	2.5	2.4	2.3
	25	2.50	-	-	-	1.8	2.5	3.2	480	730	1080	3.5	3.3	3.2
	35	3.50	-	-	-	1.8	3.5	3.7	480	1120	1240	5.2	5.0	4.8
	50	5.00	-	-	-	1.8	5.0	5.8	480	1710	2100	7.9	7.5	7.2
	60	6.00	-	-	-	1.8	6.0	6.7	480	2140	2700	9.8	9.4	9.0
2 room	71	7.10	-	-	-	1.8	7.1	7.2	480	2430	2830	11.2	10.7	10.2
	20 + 20	2.00	2.00	-	-	3.0	4.0	5.8	550	930	1910	4.4	4.2	4.0
	20 + 25	2.00	2.50	-	-	3.0	4.5	6.1	550	1170	2060	5.5	5.2	5.0
	20 + 35	2.00	3.50	-	-	3.0	5.5	6.6	550	1590	2320	7.3	7.0	6.7
	20 + 50	2.03	5.07	-	-	3.0	7.1	8.3	550	2340	2830	10.7	10.3	9.8
	20 + 60	2.00	6.00	-	-	3.0	8.0	8.3	550	2720	2830	12.5	11.9	11.4
	20 + 71	1.76	6.24	-	-	3.0	8.0	8.3	550	2720	2830	12.5	11.9	11.4
	25 + 25	2.50	2.50	-	-	3.0	5.0	6.5	550	1360	2270	6.3	6.0	5.8
	25 + 35	2.46	3.44	-	-	3.0	5.9	6.8	550	1780	2470	8.2	7.8	7.5
	25 + 50	2.47	4.93	-	-	3.0	7.4	8.3	550	2430	2830	11.2	10.7	10.2
	25 + 60	2.35	5.65	-	-	3.0	8.0	8.3	550	2720	2830	12.5	11.9	11.4
	25 + 71	2.08	5.92	-	-	3.0	8.0	8.3	550	2720	2830	12.5	11.9	11.4
	35 + 35	3.55	3.55	-	-	3.0	7.1	8.3	550	2340	2830	10.7	10.3	9.8
	35 + 50	3.29	4.71	-	-	3.0	8.0	8.3	550	2720	2830	12.5	11.9	11.4
	35 + 60	2.95	5.05	-	-	3.0	8.0	8.3	550	2720	2830	12.5	11.9	11.4
	35 + 71	2.64	5.36	-	-	3.0	8.0	8.3	550	2720	2830	12.5	11.9	11.4
	50 + 50	4.00	4.00	-	-	3.0	8.0	8.3	550	2720	2830	12.5	11.9	11.4
	50 + 60	3.64	4.36	-	-	3.0	8.0	8.3	550	2720	2830	12.5	11.9	11.4
	50 + 71	3.31	4.69	-	-	3.0	8.0	8.3	550	2720	2830	12.5	11.9	11.4
	60 + 60	4.00	4.00	-	-	3.0	8.0	8.3	550	2720	2830	12.5	11.9	11.4
60 + 71	3.66	4.34	-	-	3.0	8.0	8.3	550	2720	2830	12.5	11.9	11.4	
3 room	20 + 20 + 20	2.00	2.00	2.00	-	3.7	6.0	8.5	670	1440	2830	6.6	6.4	6.1
	20 + 20 + 25	2.00	2.00	2.50	-	3.7	6.5	8.5	670	1630	2830	7.5	7.2	6.9
	20 + 20 + 35	2.00	2.00	3.50	-	3.7	7.5	8.5	670	2040	2830	9.4	9.0	8.6
	20 + 20 + 50	1.78	1.78	4.44	-	3.7	8.0	8.5	670	2290	2830	10.5	10.1	9.6
	20 + 20 + 60	1.60	1.60	4.80	-	3.7	8.0	8.5	670	2290	2830	10.5	10.1	9.6
	20 + 20 + 71	1.44	1.44	5.12	-	3.7	8.0	8.5	670	2290	2830	10.5	10.1	9.6
	20 + 25 + 25	2.03	2.54	2.54	-	3.7	7.1	8.5	670	1870	2830	8.6	8.2	7.9
	20 + 25 + 35	2.00	2.50	3.50	-	3.7	8.0	8.5	670	2290	2830	10.5	10.1	9.6
	20 + 25 + 50	1.68	2.11	4.21	-	3.7	8.0	8.5	670	2290	2830	10.5	10.1	9.6
	20 + 25 + 60	1.52	1.90	4.57	-	3.7	8.0	8.5	670	2290	2830	10.5	10.1	9.6
	20 + 25 + 71	1.38	1.72	4.90	-	3.7	8.0	8.5	670	2290	2830	10.5	10.1	9.6
	20 + 35 + 35	1.78	3.11	3.11	-	3.7	8.0	8.5	670	2290	2830	10.5	10.1	9.6
	20 + 35 + 50	1.52	2.67	3.81	-	3.7	8.0	8.5	670	2290	2830	10.5	10.1	9.6
	20 + 35 + 60	1.39	2.43	4.17	-	3.7	8.0	8.5	670	2290	2830	10.5	10.1	9.6
	20 + 35 + 71	1.27	2.22	4.51	-	3.7	8.0	8.5	670	2290	2830	10.5	10.1	9.6
	20 + 50 + 50	1.33	3.33	3.33	-	3.7	8.0	8.5	670	2290	2830	10.5	10.1	9.6
	20 + 50 + 60	1.23	3.08	3.69	-	3.7	8.0	8.5	670	2290	2830	10.5	10.1	9.6
	25 + 25 + 25	2.50	2.50	2.50	-	3.7	7.5	8.5	670	2040	2830	9.4	9.0	8.6
	25 + 25 + 35	2.35	2.35	3.29	-	3.7	8.0	8.5	670	2290	2830	10.5	10.1	9.6
	25 + 25 + 50	2.00	2.00	4.00	-	3.7	8.0	8.5	670	2290	2830	10.5	10.1	9.6
	25 + 25 + 60	1.82	1.82	4.36	-	3.7	8.0	8.5	670	2290	2830	10.5	10.1	9.6
	25 + 25 + 71	1.65	1.65	4.69	-	3.7	8.0	8.5	670	2290	2830	10.5	10.1	9.6
	25 + 35 + 35	2.11	2.95	2.95	-	3.7	8.0	8.5	670	2290	2830	10.5	10.1	9.6
	25 + 35 + 50	1.82	2.55	3.64	-	3.7	8.0	8.5	670	2290	2830	10.5	10.1	9.6
	25 + 35 + 60	1.67	2.33	4.00	-	3.7	8.0	8.5	670	2290	2830	10.5	10.1	9.6
	25 + 35 + 71	1.53	2.14	4.34	-	3.7	8.0	8.5	670	2290	2830	10.5	10.1	9.6
	25 + 50 + 50	1.60	3.20	3.20	-	3.7	8.0	8.5	670	2290	2830	10.5	10.1	9.6
	25 + 50 + 60	1.48	2.96	3.56	-	3.7	8.0	8.5	670	2290	2830	10.5	10.1	9.6
	35 + 35 + 35	2.67	2.67	2.67	-	3.7	8.0	8.5	670	2290	2830	10.5	10.1	9.6
	35 + 35 + 50	2.33	2.33	3.33	-	3.7	8.0	8.5	670	2290	2830	10.5	10.1	9.6
	35 + 35 + 60	2.15	2.15	3.69	-	3.7	8.0	8.5	670	2290	2830	10.5	10.1	9.6
35 + 50 + 50	2.07	2.96	2.96	-	3.7	8.0	8.5	670	2290	2830	10.5	10.1	9.6	
4 room	20 + 20 + 20 + 20	2.00	2.00	2.00	2.00	4.4	8.0	8.7	890	2170	2830	10.0	9.5	9.1
	20 + 20 + 20 + 25	1.88	1.88	1.88	2.35	4.4	8.0	8.7	890	2170	2830	10.0	9.5	9.1
	20 + 20 + 20 + 35	1.68	1.68	1.68	2.95	4.4	8.0	8.7	890	2170	2830	10.0	9.5	9.1
	20 + 20 + 20 + 50	1.45	1.45	1.45	3.64	4.4	8.0	8.7	890	2170	2830	10.0	9.5	9.1
	20 + 20 + 20 + 60	1.33	1.33	1.33	4.00	4.4	8.0	8.7	890	2170	2830	10.0	9.5	9.1
	20 + 20 + 25 + 25	1.78	1.78	2.22	2.22	4.4	8.0	8.7	890	2170	2830	10.0	9.5	9.1
	20 + 20 + 25 + 35	1.60	1.60	2.00	2.80	4.4	8.0	8.7	890	2170	2830	10.0	9.5	9.1
	20 + 20 + 25 + 50	1.39	1.39	1.74	3.48	4.4	8.0	8.7	890	2170	2830	10.0	9.5	9.1
	20 + 20 + 25 + 60	1.28	1.28	1.60	3.84	4.4	8.0	8.7	890	2170	2830	10.0	9.5	9.1
	20 + 20 + 35 + 35	1.45	1.45	2.55	2.55	4.4	8.0	8.7	890	2170	2830	10.0	9.5	9.1
	20 + 20 + 35 + 50	1.28	1.28	2.24	3.20	4.4	8.0	8.7	890	2170	2830	10.0	9.5	9.1
	20 + 20 + 35 + 60	1.19	1.19	2.07	3.56	4.4	8.0	8.7	890	2170	2830	10.0	9.5	9.1
	20 + 25 + 25 + 25	1.68	2.11	2.11	2.11	4.4	8.0	8.7	890	2170	2830	10.0	9.5	9.1
	20 + 25 + 25 + 35	1.52	1.90	1.90	2.67	4.4	8.0	8.7	890	2170	2830	10.0	9.5	9.1
	20 + 25 + 25 + 50	1.33	1.67	1.67	3.33	4.4	8.0	8.7	890	2170	2830	10.0	9.5	9.1
	20 + 25 + 25 + 60	1.23	1.54	1.54	3.69	4.4	8.0	8.7	890	2170	2830	10.0	9.5	9.1
	20 + 25 + 35 + 35	1.39	1.74	2.43	2.43	4.4	8.0	8.7	890	2170	2830	10.0	9.5	9.1
	20 + 25 + 35 + 50	1.23	1.54	2.15	3.08	4.4	8.0	8.7	890	2170	2830	10.0	9.5	9.1
	20 + 35 + 35 + 35	1.28	2.24	2.24	2.24	4.4	8.0	8.7	890	2170	2830	10.0	9.5	9.1
	25 + 25 + 25 + 25	2.00	2.00	2.00	2.00	4.4	8.0	8.7	890	2170	2830	10.0	9.5	9.1
	25 + 25 + 25 + 35	1.82	1.82	1.82	2.55	4.4	8.0	8.7	890	2170	2830	10.0	9.5	9.1
	25 + 25 + 25 + 50	1.60	1.60	1.60	3.20	4.4	8.0	8.7	890	2170	2830	10.0	9.5	9.1
	25 + 25 + 25 + 60	1.48	1.48	1.48	3.56	4.4	8.0	8.7	890	2170	2830	10.0	9.5	9.1
	25 + 25 + 35 + 35	1.67	1.67	2.33	2.33	4.4	8.0	8.7	890	2170	2830	10.0	9.5	9.1
	25 + 25 + 35 + 50	1.48	1.48	2.07	2.96	4.4	8.0	8.7	890	2170	2830	10.0	9.5	9.1
25 + 35 + 35 + 35	1.54	2.15	2.15	2.15	4.4	8.0	8.7	890	2170	2830	10.0	9.5	9.1	



MULTI-SPLIT SYSTEM

SCM100ZS-W Table of Indoor unit combination with all indoor unit

Indoor unit combination		Heating capacity (kW)							Power consumption(W)			Standard current(A)			
		Room heating capacity					Total capacity		Min.	Standard	Max.	220V	230V	240V	
		A	B	C	D	E	Min.	Standard							Max.
1 room	20	3.00	-	-	-	-	0.9	3.0	3.5	490	1060	1330	5.1	4.8	4.6
	25	3.40	-	-	-	-	0.9	3.4	4.0	490	1140	1400	5.4	5.2	5.0
	35	4.50	-	-	-	-	0.9	4.5	4.8	490	1350	1570	6.3	6.1	5.8
	50	5.80	-	-	-	-	0.9	5.8	6.2	490	1610	1770	7.4	7.1	6.8
	60	6.80	-	-	-	-	0.9	6.8	7.1	490	1800	1920	8.3	7.9	7.6
	71	8.00	-	-	-	-	0.9	8.0	8.1	490	2030	2110	9.3	8.9	8.5
	80	9.00	-	-	-	-	0.9	9.0	9.1	490	2220	2260	10.2	9.7	9.3
	20 + 20	2.70	2.70	-	-	-	1.2	5.4	7.0	460	1170	1610	5.5	5.2	5.0
2 room	20 + 25	2.62	3.28	-	-	-	1.2	5.9	7.3	460	1310	1690	6.0	5.8	5.5
	20 + 35	2.51	4.39	-	-	-	1.2	6.9	7.9	460	1580	1860	7.3	6.9	6.6
	20 + 50	2.51	6.29	-	-	-	1.2	8.8	9.2	460	2130	2240	9.8	9.4	9.0
	20 + 60	2.45	7.35	-	-	-	1.2	9.8	10.3	460	2430	2580	11.2	10.7	10.2
	20 + 71	2.31	8.19	-	-	-	1.2	10.5	11.2	460	2620	2900	12.0	11.5	11.0
	20 + 80	2.10	8.40	-	-	-	1.2	10.5	11.2	460	2620	2900	12.0	11.5	11.0
	25 + 25	3.20	3.20	-	-	-	1.2	6.4	7.7	460	1440	1810	6.6	6.3	6.1
	25 + 35	3.25	4.55	-	-	-	1.2	7.8	8.2	460	1830	1950	8.4	8.0	7.7
	25 + 50	3.07	6.13	-	-	-	1.2	9.2	9.6	460	2240	2370	10.3	9.8	9.4
	25 + 60	3.00	7.20	-	-	-	1.2	10.2	10.7	460	2550	2710	11.7	11.2	10.7
	25 + 71	2.73	7.77	-	-	-	1.2	10.5	11.2	460	2620	2900	12.0	11.5	11.0
	25 + 80	2.50	8.00	-	-	-	1.2	10.5	11.2	460	2620	2900	12.0	11.5	11.0
	35 + 35	4.50	4.50	-	-	-	1.2	9.0	9.4	460	2180	2310	10.0	9.6	9.2
	35 + 50	4.24	6.06	-	-	-	1.2	10.3	10.8	460	2560	2740	11.8	11.2	10.8
	35 + 60	3.87	6.63	-	-	-	1.2	10.5	11.2	460	2620	2900	12.0	11.5	11.0
	35 + 71	3.47	7.03	-	-	-	1.2	10.5	11.2	460	2620	2900	12.0	11.5	11.0
	35 + 80	3.20	7.30	-	-	-	1.2	10.5	11.2	460	2620	2900	12.0	11.5	11.0
	50 + 50	5.25	5.25	-	-	-	1.2	10.5	11.2	460	2620	2900	12.0	11.5	11.0
	50 + 60	4.77	5.73	-	-	-	1.2	10.5	11.2	460	2620	2900	12.0	11.5	11.0
	50 + 71	4.34	6.16	-	-	-	1.2	10.5	11.2	460	2620	2900	12.0	11.5	11.0
	50 + 80	4.04	6.46	-	-	-	1.2	10.5	11.2	460	2620	2900	12.0	11.5	11.0
	60 + 60	5.25	5.25	-	-	-	1.2	10.5	11.2	460	2620	2900	12.0	11.5	11.0
	60 + 71	4.81	5.69	-	-	-	1.2	10.5	11.2	460	2620	2900	12.0	11.5	11.0
	60 + 80	4.50	6.00	-	-	-	1.2	10.5	11.2	460	2620	2900	12.0	11.5	11.0
	71 + 71	5.25	5.25	-	-	-	1.2	10.5	11.2	460	2620	2900	12.0	11.5	11.0
	71 + 80	4.94	5.56	-	-	-	1.2	10.5	11.2	460	2620	2900	12.0	11.5	11.0
	80 + 80	5.25	5.25	-	-	-	1.2	10.5	11.2	460	2620	2900	12.0	11.5	11.0
	3 room	20 + 20 + 20	3.00	3.00	3.00	-	-	1.4	9.0	9.6	430	2140	2320	9.8	9.4
20 + 20 + 25		2.89	2.89	3.62	-	-	1.4	9.4	10.0	430	2260	2440	10.4	9.9	9.5
20 + 20 + 35		2.80	2.80	4.90	-	-	1.4	10.5	11.3	430	2540	2900	11.7	11.2	10.7
20 + 20 + 50		2.33	2.33	5.83	-	-	1.4	10.5	11.3	430	2540	2900	11.7	11.2	10.7
20 + 20 + 60		2.10	2.10	6.30	-	-	1.4	10.5	11.3	430	2540	2900	11.7	11.2	10.7
20 + 20 + 71		1.89	1.89	6.72	-	-	1.4	10.5	11.3	430	2540	2900	11.7	11.2	10.7
20 + 20 + 80		1.75	1.75	7.00	-	-	1.4	10.5	11.3	430	2540	2900	11.7	11.2	10.7
20 + 25 + 25		3.00	3.75	3.75	-	-	1.4	10.5	11.3	430	2540	2900	11.7	11.2	10.7
20 + 25 + 35		2.63	3.28	4.59	-	-	1.4	10.5	11.3	430	2540	2900	11.7	11.2	10.7
20 + 25 + 50		2.21	2.76	5.53	-	-	1.4	10.5	11.3	430	2540	2900	11.7	11.2	10.7
20 + 25 + 60		2.00	2.50	6.00	-	-	1.4	10.5	11.3	430	2540	2900	11.7	11.2	10.7
20 + 35 + 35		2.33	4.08	4.08	-	-	1.4	10.5	11.3	430	2540	2900	11.7	11.2	10.7
20 + 35 + 50		2.00	3.50	5.00	-	-	1.4	10.5	11.3	430	2540	2900	11.7	11.2	10.7
20 + 35 + 60		1.83	3.20	5.48	-	-	1.4	10.5	11.3	430	2540	2900	11.7	11.2	10.7
20 + 35 + 71		1.67	2.92	5.92	-	-	1.4	10.5	11.3	430	2540	2900	11.7	11.2	10.7
20 + 35 + 80		1.56	2.72	6.22	-	-	1.4	10.5	11.3	430	2540	2900	11.7	11.2	10.7
20 + 50 + 50		1.75	4.38	4.38	-	-	1.4	10.5	11.3	430	2540	2900	11.7	11.2	10.7
20 + 50 + 60		1.62	4.04	4.85	-	-	1.4	10.5	11.3	430	2540	2900	11.7	11.2	10.7
20 + 50 + 71		1.49	3.72	5.29	-	-	1.4	10.5	11.3	430	2540	2900	11.7	11.2	10.7
20 + 50 + 80		1.40	3.50	5.60	-	-	1.4	10.5	11.3	430	2540	2900	11.7	11.2	10.7
20 + 60 + 60		1.50	4.50	4.50	-	-	1.4	10.5	11.3	430	2540	2900	11.7	11.2	10.7
20 + 60 + 71		1.39	4.17	4.94	-	-	1.4	10.5	11.3	430	2540	2900	11.7	11.2	10.7
20 + 60 + 80		1.31	3.94	5.25	-	-	1.4	10.5	11.3	430	2540	2900	11.7	11.2	10.7
25 + 25 + 25		3.50	3.50	3.50	-	-	1.4	10.5	11.3	430	2540	2900	11.7	11.2	10.7
25 + 25 + 35		3.09	3.09	4.32	-	-	1.4	10.5	11.3	430	2540	2900	11.7	11.2	10.7
25 + 25 + 50		2.63	2.63	5.25	-	-	1.4	10.5	11.3	430	2540	2900	11.7	11.2	10.7
25 + 25 + 60		2.39	2.39	5.73	-	-	1.4	10.5	11.3	430	2540	2900	11.7	11.2	10.7
25 + 25 + 71		2.17	2.17	6.16	-	-	1.4	10.5	11.3	430	2540	2900	11.7	11.2	10.7
25 + 25 + 80		2.02	2.02	6.46	-	-	1.4	10.5	11.3	430	2540	2900	11.7	11.2	10.7
25 + 35 + 35		2.76	3.87	3.87	-	-	1.4	10.5	11.3	430	2540	2900	11.7	11.2	10.7
25 + 35 + 50		2.39	3.34	4.77	-	-	1.4	10.5	11.3	430	2540	2900	11.7	11.2	10.7
25 + 35 + 60		2.19	3.06	5.25	-	-	1.4	10.5	11.3	430	2540	2900	11.7	11.2	10.7
25 + 35 + 71	2.00	2.81	5.69	-	-	1.4	10.5	11.3	430	2540	2900	11.7	11.2	10.7	
25 + 35 + 80	1.88	2.63	6.00	-	-	1.4	10.5	11.3	430	2540	2900	11.7	11.2	10.7	
25 + 50 + 50	2.10	4.20	4.20	-	-	1.4	10.5	11.3	430	2540	2900	11.7	11.2	10.7	
25 + 50 + 60	1.94	3.89	4.67	-	-	1.4	10.5	11.3	430	2540	2900	11.7	11.2	10.7	
25 + 50 + 71	1.80	3.60	5.11	-	-	1.4	10.5	11.3	430	2540	2900	11.7	11.2	10.7	
25 + 50 + 80	1.69	3.39	5.42	-	-	1.4	10.5	11.3	430	2540	2900	11.7	11.2	10.7	
25 + 60 + 60	1.81	4.34	4.34	-	-	1.4	10.5	11.3	430	2540	2900	11.7	11.2	10.7	
25 + 60 + 71	1.68	4.04	4.78	-	-	1.4	10.5	11.3	430	2540	2900	11.7	11.2	10.7	

COMBINATIONS

Indoor unit combination			Heating capacity (kW)							Power consumption(W)			Standard current(A)			
			Room heating capacity					Total capacity			Min.	Standard	Max.	220V	230V	240V
			A	B	C	D	E	Min.	Standard	Max.						
3 room	35 + 35 + 35	3.50	3.50	3.50	-	-	1.4	10.5	11.3	430	2540	2900	11.7	11.2	10.7	
	35 + 35 + 50	3.06	3.06	4.38	-	-	1.4	10.5	11.3	430	2540	2900	11.7	11.2	10.7	
	35 + 35 + 60	2.83	2.83	4.85	-	-	1.4	10.5	11.3	430	2540	2900	11.7	11.2	10.7	
	35 + 35 + 71	2.61	2.61	5.29	-	-	1.4	10.5	11.3	430	2540	2900	11.7	11.2	10.7	
	35 + 35 + 80	2.45	2.45	5.60	-	-	1.4	10.5	11.3	430	2540	2900	11.7	11.2	10.7	
	35 + 50 + 50	2.72	3.89	3.89	-	-	1.4	10.5	11.3	430	2540	2900	11.7	11.2	10.7	
	35 + 50 + 60	2.53	3.62	4.34	-	-	1.4	10.5	11.3	430	2540	2900	11.7	11.2	10.7	
	35 + 50 + 71	2.36	3.37	4.78	-	-	1.4	10.5	11.3	430	2540	2900	11.7	11.2	10.7	
	35 + 60 + 60	2.37	4.06	4.06	-	-	1.4	10.5	11.3	430	2540	2900	11.7	11.2	10.7	
	50 + 50 + 50	3.50	3.50	3.50	-	-	1.4	10.5	11.3	430	2540	2900	11.7	11.2	10.7	
50 + 50 + 60	3.28	3.28	3.94	-	-	1.4	10.5	11.3	430	2540	2900	11.7	11.2	10.7		
Heating operation 4 room	20 + 20 + 20 + 20	2.63	2.63	2.63	2.63	-	1.6	10.5	11.4	400	2460	2900	11.3	10.8	10.4	
	20 + 20 + 20 + 25	2.47	2.47	2.47	3.09	-	1.6	10.5	11.4	400	2460	2900	11.3	10.8	10.4	
	20 + 20 + 20 + 35	2.21	2.21	2.21	3.87	-	1.6	10.5	11.4	400	2460	2900	11.3	10.8	10.4	
	20 + 20 + 20 + 50	1.91	1.91	1.91	4.77	-	1.6	10.5	11.4	400	2460	2900	11.3	10.8	10.4	
	20 + 20 + 20 + 60	1.75	1.75	1.75	5.25	-	1.6	10.5	11.4	400	2460	2900	11.3	10.8	10.4	
	20 + 20 + 20 + 71	1.60	1.60	1.60	5.69	-	1.6	10.5	11.4	400	2460	2900	11.3	10.8	10.4	
	20 + 20 + 20 + 80	1.50	1.50	1.50	6.00	-	1.6	10.5	11.4	400	2460	2900	11.3	10.8	10.4	
	20 + 20 + 25 + 25	2.33	2.33	2.92	2.92	-	1.6	10.5	11.4	400	2460	2900	11.3	10.8	10.4	
	20 + 20 + 25 + 35	2.10	2.10	2.63	3.68	-	1.6	10.5	11.4	400	2460	2900	11.3	10.8	10.4	
	20 + 20 + 25 + 50	1.83	1.83	2.28	4.57	-	1.6	10.5	11.4	400	2460	2900	11.3	10.8	10.4	
	20 + 20 + 25 + 60	1.68	1.68	2.10	5.04	-	1.6	10.5	11.4	400	2460	2900	11.3	10.8	10.4	
	20 + 20 + 25 + 71	1.54	1.54	1.93	5.48	-	1.6	10.5	11.4	400	2460	2900	11.3	10.8	10.4	
	20 + 20 + 25 + 80	1.45	1.45	1.81	5.79	-	1.6	10.5	11.4	400	2460	2900	11.3	10.8	10.4	
	20 + 20 + 35 + 35	1.91	1.91	3.34	3.34	-	1.6	10.5	11.4	400	2460	2900	11.3	10.8	10.4	
	20 + 20 + 35 + 50	1.68	1.68	2.94	4.20	-	1.6	10.5	11.4	400	2460	2900	11.3	10.8	10.4	
	20 + 20 + 35 + 60	1.56	1.56	2.72	4.67	-	1.6	10.5	11.4	400	2460	2900	11.3	10.8	10.4	
	20 + 20 + 35 + 71	1.44	1.44	2.52	5.11	-	1.6	10.5	11.4	400	2460	2900	11.3	10.8	10.4	
	20 + 20 + 35 + 80	1.35	1.35	2.37	5.42	-	1.6	10.5	11.4	400	2460	2900	11.3	10.8	10.4	
	20 + 20 + 50 + 50	1.50	1.50	3.75	3.75	-	1.6	10.5	11.4	400	2460	2900	11.3	10.8	10.4	
	20 + 20 + 50 + 60	1.40	1.40	3.50	4.20	-	1.6	10.5	11.4	400	2460	2900	11.3	10.8	10.4	
	20 + 20 + 60 + 60	1.31	1.31	3.94	3.94	-	1.6	10.5	11.4	400	2460	2900	11.3	10.8	10.4	
	20 + 25 + 25 + 25	2.21	2.76	2.76	2.76	-	1.6	10.5	11.4	400	2460	2900	11.3	10.8	10.4	
	20 + 25 + 25 + 35	2.00	2.50	2.50	3.50	-	1.6	10.5	11.4	400	2460	2900	11.3	10.8	10.4	
	20 + 25 + 25 + 50	1.75	2.19	2.19	4.38	-	1.6	10.5	11.4	400	2460	2900	11.3	10.8	10.4	
	20 + 25 + 25 + 60	1.62	2.02	2.02	4.85	-	1.6	10.5	11.4	400	2460	2900	11.3	10.8	10.4	
	20 + 25 + 25 + 71	1.49	1.86	1.86	5.29	-	1.6	10.5	11.4	400	2460	2900	11.3	10.8	10.4	
	20 + 25 + 25 + 80	1.40	1.75	1.75	5.60	-	1.6	10.5	11.4	400	2460	2900	11.3	10.8	10.4	
	20 + 25 + 35 + 35	1.83	2.28	3.20	3.20	-	1.6	10.5	11.4	400	2460	2900	11.3	10.8	10.4	
	20 + 25 + 35 + 50	1.62	2.02	2.83	4.04	-	1.6	10.5	11.4	400	2460	2900	11.3	10.8	10.4	
	20 + 25 + 35 + 60	1.50	1.88	2.63	4.50	-	1.6	10.5	11.4	400	2460	2900	11.3	10.8	10.4	
	20 + 25 + 35 + 71	1.39	1.74	2.43	4.94	-	1.6	10.5	11.4	400	2460	2900	11.3	10.8	10.4	
	20 + 25 + 35 + 80	1.31	1.64	2.30	5.25	-	1.6	10.5	11.4	400	2460	2900	11.3	10.8	10.4	
	20 + 25 + 50 + 50	1.45	1.81	3.62	3.62	-	1.6	10.5	11.4	400	2460	2900	11.3	10.8	10.4	
	20 + 25 + 50 + 60	1.35	1.69	3.39	4.06	-	1.6	10.5	11.4	400	2460	2900	11.3	10.8	10.4	
	20 + 35 + 35 + 35	1.68	2.94	2.94	2.94	-	1.6	10.5	11.4	400	2460	2900	11.3	10.8	10.4	
	20 + 35 + 35 + 50	1.50	2.63	2.63	3.75	-	1.6	10.5	11.4	400	2460	2900	11.3	10.8	10.4	
	20 + 35 + 35 + 60	1.40	2.45	2.45	4.20	-	1.6	10.5	11.4	400	2460	2900	11.3	10.8	10.4	
	20 + 35 + 50 + 50	1.35	2.37	3.39	3.39	-	1.6	10.5	11.4	400	2460	2900	11.3	10.8	10.4	
	25 + 25 + 25 + 25	2.63	2.63	2.63	2.63	-	1.6	10.5	11.4	400	2460	2900	11.3	10.8	10.4	
	25 + 25 + 25 + 35	2.39	2.39	2.39	3.34	-	1.6	10.5	11.4	400	2460	2900	11.3	10.8	10.4	
	25 + 25 + 25 + 50	2.10	2.10	2.10	4.20	-	1.6	10.5	11.4	400	2460	2900	11.3	10.8	10.4	
	25 + 25 + 25 + 60	1.94	1.94	1.94	4.67	-	1.6	10.5	11.4	400	2460	2900	11.3	10.8	10.4	
	25 + 25 + 25 + 71	1.80	1.80	1.80	5.11	-	1.6	10.5	11.4	400	2460	2900	11.3	10.8	10.4	
	25 + 25 + 25 + 80	1.69	1.69	1.69	5.42	-	1.6	10.5	11.4	400	2460	2900	11.3	10.8	10.4	
	25 + 25 + 35 + 35	2.19	2.19	3.06	3.06	-	1.6	10.5	11.4	400	2460	2900	11.3	10.8	10.4	
25 + 25 + 35 + 50	1.94	1.94	2.72	3.89	-	1.6	10.5	11.4	400	2460	2900	11.3	10.8	10.4		
25 + 25 + 35 + 60	1.81	1.81	2.53	4.34	-	1.6	10.5	11.4	400	2460	2900	11.3	10.8	10.4		
25 + 25 + 35 + 71	1.68	1.68	2.36	4.78	-	1.6	10.5	11.4	400	2460	2900	11.3	10.8	10.4		
25 + 25 + 50 + 50	1.75	1.75	3.50	3.50	-	1.6	10.5	11.4	400	2460	2900	11.3	10.8	10.4		
25 + 25 + 50 + 60	1.64	1.64	3.28	3.94	-	1.6	10.5	11.4	400	2460	2900	11.3	10.8	10.4		
25 + 35 + 35 + 35	2.02	2.83	2.83	2.83	-	1.6	10.5	11.4	400	2460	2900	11.3	10.8	10.4		
25 + 35 + 35 + 50	1.81	2.53	2.53	3.62	-	1.6	10.5	11.4	400	2460	2900	11.3	10.8	10.4		
25 + 35 + 35 + 60	1.69	2.37	2.37	4.06	-	1.6	10.5	11.4	400	2460	2900	11.3	10.8	10.4		
25 + 35 + 50 + 50	1.64	2.30	3.28	3.28	-	1.6	10.5	11.4	400	2460	2900	11.3	10.8	10.4		
35 + 35 + 35 + 35	2.63	2.63	2.63	2.63	-	1.6	10.5	11.4	400	2460	2900	11.3	10.8	10.4		
35 + 35 + 35 + 50	2.37	2.37	2.37	3.39	-	1.6	10.5	11.4	400	2460	2900	11.3	10.8	10.4		
5 room	20 + 20 + 20 + 20 + 20	2.10	2.10	2.10	2.10	2.10	1.8	10.5	11.5	370	2380	2900	10.9	10.5	10.0	
	20 + 20 + 20 + 20 + 25	2.00	2.00	2.00	2.00	2.50	1.8	10.5	11.5	370	2380	2900	10.9	10.5	10.0	
	20 + 20 + 20 + 20 + 35	1.83	1.83	1.83	1.83	3.20	1.8	10.5	11.5	370	2380	2900	10.9	10.5	10.0	
	20 + 20 + 20 + 20 + 50	1.62	1.62	1.62	1.62	4.04	1.8	10.5	11.5	370	2380	2900	10.9	10.5	10.0	
	20 + 20 + 20 + 20 + 60	1.50	1.50	1.50	1.50	4.50	1.8	10.5	11.5	370	2380	2900	10.9	10.5	10.0	
	20 + 20 + 20 + 25 + 25	1.91	1.91	1.91	2.39	2.39	1.8	10.5	11.5	370	2380	2900	10.9	10.5	10.0	
20 + 20 + 20 + 25 + 35	1.75	1.75	1.75	2.19	3.06	1.8	10.5	11.5	370	2380	2900	10.9	10.5	10.0		



MULTI-SPLIT SYSTEM

Indoor unit combination		Heating capacity (kW)							Power consumption(W)			Standard current(A)				
		Room heating capacity					Total capacity			Min.	Standard	Max.	220V	230V	240V	
		A	B	C	D	E	Min.	Standard	Max.							
Heating operation	5 room	20 + 20 + 20 + 25 + 50	1.56	1.56	1.56	1.94	3.89	1.8	10.5	11.5	370	2380	2900	10.9	10.5	10.0
		20 + 20 + 20 + 25 + 60	1.45	1.45	1.45	1.81	4.34	1.8	10.5	11.5	370	2380	2900	10.9	10.5	10.0
		20 + 20 + 20 + 35 + 35	1.62	1.62	1.62	2.83	2.83	1.8	10.5	11.5	370	2380	2900	10.9	10.5	10.0
		20 + 20 + 20 + 35 + 50	1.45	1.45	1.45	2.53	3.62	1.8	10.5	11.5	370	2380	2900	10.9	10.5	10.0
		20 + 20 + 20 + 35 + 60	1.35	1.35	1.35	2.37	4.06	1.8	10.5	11.5	370	2380	2900	10.9	10.5	10.0
		20 + 20 + 25 + 25 + 25	1.83	1.83	2.28	2.28	2.28	1.8	10.5	11.5	370	2380	2900	10.9	10.5	10.0
		20 + 20 + 25 + 25 + 35	1.68	1.68	2.10	2.10	2.94	1.8	10.5	11.5	370	2380	2900	10.9	10.5	10.0
		20 + 20 + 25 + 25 + 50	1.50	1.50	1.88	1.88	3.75	1.8	10.5	11.5	370	2380	2900	10.9	10.5	10.0
		20 + 20 + 25 + 25 + 60	1.40	1.40	1.75	1.75	4.20	1.8	10.5	11.5	370	2380	2900	10.9	10.5	10.0
		20 + 20 + 25 + 35 + 35	1.56	1.56	1.94	2.72	2.72	1.8	10.5	11.5	370	2380	2900	10.9	10.5	10.0
		20 + 20 + 25 + 35 + 50	1.40	1.40	1.75	2.45	3.50	1.8	10.5	11.5	370	2380	2900	10.9	10.5	10.0
		20 + 20 + 25 + 35 + 60	1.31	1.31	1.64	2.30	3.94	1.8	10.5	11.5	370	2380	2900	10.9	10.5	10.0
		20 + 20 + 35 + 35 + 35	1.45	1.45	2.53	2.53	2.53	1.8	10.5	11.5	370	2380	2900	10.9	10.5	10.0
		20 + 20 + 35 + 35 + 50	1.31	1.31	2.30	2.30	3.28	1.8	10.5	11.5	370	2380	2900	10.9	10.5	10.0
		20 + 25 + 25 + 25 + 25	1.75	2.19	2.19	2.19	2.19	1.8	10.5	11.5	370	2380	2900	10.9	10.5	10.0
		20 + 25 + 25 + 25 + 35	1.62	2.02	2.02	2.02	2.83	1.8	10.5	11.5	370	2380	2900	10.9	10.5	10.0
		20 + 25 + 25 + 25 + 50	1.45	1.81	1.81	1.81	3.62	1.8	10.5	11.5	370	2380	2900	10.9	10.5	10.0
		20 + 25 + 25 + 25 + 60	1.35	1.69	1.69	1.69	4.06	1.8	10.5	11.5	370	2380	2900	10.9	10.5	10.0
		20 + 25 + 25 + 35 + 35	1.50	1.88	1.88	2.63	2.63	1.8	10.5	11.5	370	2380	2900	10.9	10.5	10.0
		20 + 25 + 25 + 35 + 50	1.35	1.69	1.69	2.37	3.39	1.8	10.5	11.5	370	2380	2900	10.9	10.5	10.0
		20 + 25 + 35 + 35 + 35	1.40	1.75	2.45	2.45	2.45	1.8	10.5	11.5	370	2380	2900	10.9	10.5	10.0
		20 + 35 + 35 + 35 + 35	1.31	2.30	2.30	2.30	2.30	1.8	10.5	11.5	370	2380	2900	10.9	10.5	10.0
		25 + 25 + 25 + 25 + 25	2.10	2.10	2.10	2.10	2.10	1.8	10.5	11.5	370	2380	2900	10.9	10.5	10.0
		25 + 25 + 25 + 25 + 35	1.94	1.94	1.94	1.94	2.72	1.8	10.5	11.5	370	2380	2900	10.9	10.5	10.0
		25 + 25 + 25 + 25 + 50	1.75	1.75	1.75	1.75	3.50	1.8	10.5	11.5	370	2380	2900	10.9	10.5	10.0
		25 + 25 + 25 + 25 + 60	1.64	1.64	1.64	1.64	3.94	1.8	10.5	11.5	370	2380	2900	10.9	10.5	10.0
		25 + 25 + 25 + 35 + 35	1.81	1.81	1.81	2.53	2.53	1.8	10.5	11.5	370	2380	2900	10.9	10.5	10.0
		25 + 25 + 25 + 35 + 50	1.64	1.64	1.64	2.30	3.28	1.8	10.5	11.5	370	2380	2900	10.9	10.5	10.0
25 + 25 + 35 + 35 + 35	1.69	1.69	2.37	2.37	2.37	1.8	10.5	11.5	370	2380	2900	10.9	10.5	10.0		

Indoor unit combination		Cooling capacity (kW)							Power consumption(W)			Standard current(A)				
		Room cooling capacity					Total capacity			Min.	Standard	Max.	220V	230V	240V	
		A	B	C	D	E	Min.	Standard	Max.							
Cooling operation	1 room	20	2.00	-	-	-	-	1.7	2.0	2.7	500	530	950	2.5	2.4	2.3
		25	2.50	-	-	-	-	1.7	2.5	3.2	500	690	1008	3.3	3.1	3.0
		35	3.50	-	-	-	-	1.7	3.5	3.7	500	1010	1340	4.8	4.6	4.4
		50	5.00	-	-	-	-	1.7	5.0	5.8	500	1490	1730	6.9	6.6	6.3
		60	6.00	-	-	-	-	1.7	6.0	6.7	500	1810	1990	8.3	8.0	7.6
		71	7.10	-	-	-	-	1.7	7.10	7.2	500	2170	2270	10.1	9.6	9.2
		80	8.00	-	-	-	-	1.7	8.00	8.1	500	2450	2500	11.4	10.9	10.4
		20 + 20	2.00	2.00	-	-	-	-	1.9	4.0	5.8	495	850	1430	4.0	3.8
20 + 25	2.00	2.50	-	-	-	-	1.9	4.5	6.1	495	1010	1540	4.7	4.5	4.3	
20 + 35	2.00	3.50	-	-	-	-	1.9	5.5	6.6	495	1330	1720	6.2	5.9	5.7	
20 + 50	2.00	5.00	-	-	-	-	1.9	7.0	7.7	495	1880	2170	8.6	8.2	7.9	
20 + 60	2.00	6.00	-	-	-	-	1.9	8.0	8.8	495	2300	2690	10.7	10.2	9.8	
20 + 71	2.00	7.10	-	-	-	-	1.9	9.1	10.0	495	2850	3420	13.2	12.6	12.1	
20 + 80	2.00	8.00	-	-	-	-	1.9	10.0	10.3	495	3450	3650	16.0	15.3	14.7	
25 + 25	2.50	2.50	-	-	-	-	1.9	5.0	6.5	495	1170	1690	5.4	5.2	5.0	
25 + 35	2.50	3.50	-	-	-	-	1.9	6.0	6.8	495	1600	1800	7.4	7.1	6.8	
25 + 50	2.50	5.00	-	-	-	-	1.9	7.5	8.4	495	2080	2490	9.6	9.2	8.8	
25 + 60	2.50	6.00	-	-	-	-	1.9	8.5	9.4	495	2630	3020	12.2	11.7	11.2	
25 + 71	2.50	7.10	-	-	-	-	1.9	9.6	10.2	495	3140	3570	14.6	13.9	13.4	
25 + 80	2.38	7.62	-	-	-	-	1.9	10.0	10.3	495	3450	3650	16.0	15.3	14.7	
35 + 35	3.50	3.50	-	-	-	-	1.9	7.0	7.7	495	1880	2170	8.6	8.2	7.9	
35 + 50	3.50	5.00	-	-	-	-	1.9	8.5	9.4	495	2630	3020	12.2	11.7	11.2	
35 + 60	3.50	6.00	-	-	-	-	1.9	9.5	10.2	495	3080	3570	14.3	13.7	13.1	
35 + 71	3.30	6.70	-	-	-	-	1.9	10.0	10.3	495	3450	3650	16.0	15.3	14.7	
35 + 80	3.04	6.96	-	-	-	-	1.9	10.0	10.3	495	3450	3650	16.0	15.3	14.7	
50 + 50	5.00	5.00	-	-	-	-	1.9	10.0	10.3	495	3450	3650	16.0	15.3	14.7	
50 + 60	4.55	5.45	-	-	-	-	1.9	10.0	10.3	495	3450	3650	16.0	15.3	14.7	
50 + 71	4.13	5.87	-	-	-	-	1.9	10.0	10.3	495	3450	3650	16.0	15.3	14.7	
50 + 80	3.85	6.15	-	-	-	-	1.9	10.0	10.3	495	3450	3650	16.0	15.3	14.7	
60 + 60	5.00	5.00	-	-	-	-	1.9	10.0	10.3	495	3450	3650	16.0	15.3	14.7	
60 + 71	4.58	5.42	-	-	-	-	1.9	10.0	10.3	495	3450	3650	16.0	15.3	14.7	
60 + 80	4.29	5.71	-	-	-	-	1.9	10.0	10.3	495	3450	3650	16.0	15.3	14.7	
71 + 71	5.00	5.00	-	-	-	-	1.9	10.0	10.3	495	3450	3650	16.0	15.3	14.7	
71 + 80	4.70	5.30	-	-	-	-	1.9	10.0	10.3	495	3450	3650	16.0	15.3	14.7	
80 + 80	5.00	5.00	-	-	-	-	1.9	10.0	10.3	495	3450	3650	16.0	15.3	14.7	
20 + 20 + 20	2.00	2.00	2.00	-	-	-	2.1	6.0	7.4	490	1430	1930	6.6	6.3	6.1	
20 + 20 + 25	2.00	2.00	2.50	-	-	-	2.1	6.5	7.7	490	1600	2050	7.4	7.1	6.8	
20 + 20 + 35	2.00	2.00	3.50	-	-	-	2.1	7.5	8.6	490	1970	2430	9.1	8.7	8.4	
20 + 20 + 50	2.00	2.00	5.00	-	-	-	2.1	9.0	9.6	490	2610	2920	12.1	11.6	11.1	
20 + 20 + 60	2.00	2.00	6.00	-	-	-	2.1	10.0	10.7	490	3230	3650	15.0	14.3	13.7	
20 + 20 + 71	1.80	1.80	6.40	-	-	-	2.1	10.0	10.7	490	3230	3650	15.0	14.3	13.7	
20 + 20 + 80	1.67	1.67	6.67	-	-	-	2.1	10.0	10.7	490	3230	3650	15.0	14.3	13.7	
20 + 25 + 25	2.00	2.50	2.50	-	-	-	2.1	7.0	8.0	490	1780	2170	8.2	7.8	7.5	
20 + 25 + 35	2.00	2.50	3.50	-	-	-	2.1	8.0	9.0	490	2170	2160	10.1	9.6	9.2	
20 + 25 + 50	2.00	2.50	5.00	-	-	-	2.1	9.5	10.3	490	2870	3340	13.3	12.7	12.2	
20 + 25 + 60	1.90	2.38	5.71	-	-	-	2.1	10.0	10.7	490	3230	3650	15.0	14.3	13.7	
20 + 35 + 35	2.00	3.50	3.50	-	-	-	2.1	9.0	9.6	490	2610	2920	12.1	11.6	11.1	

COMBINATIONS

Indoor unit combination		Cooling capacity (kW)								Power consumption(W)			Standard current(A)			
		Room cooling capacity					Total capacity			Min.	Standard	Max.	220V	230V	240V	
		A	B	C	D	E	Min.	Standard	Max.							
Cooling operation	3 room	20 + 35 + 50	1.90	3.33	4.76	-	-	2.1	10.0	10.7	490	3230	3650	15.0	14.3	13.7
		20 + 35 + 60	1.74	3.04	5.22	-	-	2.1	10.0	10.7	490	3230	3650	15.0	14.3	13.7
		20 + 35 + 71	1.59	2.78	5.63	-	-	2.1	10.0	10.7	490	3230	3650	15.0	14.3	13.7
		20 + 35 + 80	1.48	2.59	5.93	-	-	2.1	10.0	10.7	490	3230	3650	15.0	14.3	13.7
		20 + 50 + 50	1.67	4.17	4.17	-	-	2.1	10.0	10.7	490	3230	3650	15.0	14.3	13.7
		20 + 50 + 60	1.54	3.85	4.62	-	-	2.1	10.0	10.7	490	3230	3650	15.0	14.3	13.7
		20 + 50 + 71	1.42	3.55	5.04	-	-	2.1	10.0	10.7	490	3230	3650	15.0	14.3	13.7
		20 + 50 + 80	1.33	3.33	5.33	-	-	2.1	10.0	10.7	490	3230	3650	15.0	14.3	13.7
		20 + 60 + 60	1.43	4.29	4.29	-	-	2.1	10.0	10.7	490	3230	3650	15.0	14.3	13.7
		20 + 60 + 71	1.32	3.97	4.70	-	-	2.1	10.0	10.7	490	3230	3650	15.0	14.3	13.7
		20 + 60 + 80	1.25	3.75	5.00	-	-	2.1	10.0	10.7	490	3230	3650	15.0	14.3	13.7
		25 + 25 + 25	2.50	2.50	2.50	-	-	2.1	7.5	8.6	490	1970	2430	9.1	8.7	8.4
		25 + 25 + 35	2.50	2.50	3.50	-	-	2.1	8.5	9.2	490	2380	2710	11.0	10.6	10.1
		25 + 25 + 50	2.50	2.50	5.00	-	-	2.1	10.0	10.7	490	3230	3650	15.0	14.3	13.7
		25 + 25 + 60	2.27	2.27	5.45	-	-	2.1	10.0	10.7	490	3230	3650	15.0	14.3	13.7
		25 + 25 + 71	2.07	2.07	5.87	-	-	2.1	10.0	10.7	490	3230	3650	15.0	14.3	13.7
		25 + 25 + 80	1.92	1.92	6.15	-	-	2.1	10.0	10.7	490	3230	3650	15.0	14.3	13.7
		25 + 35 + 35	2.50	3.50	3.50	-	-	2.1	9.5	10.3	490	2870	3340	13.3	12.7	12.2
		25 + 35 + 50	2.27	3.18	4.55	-	-	2.1	10.0	10.7	490	3230	3650	15.0	14.3	13.7
		25 + 35 + 60	2.08	2.92	5.00	-	-	2.1	10.0	10.7	490	3230	3650	15.0	14.3	13.7
		25 + 35 + 71	1.91	2.67	5.42	-	-	2.1	10.0	10.7	490	3230	3650	15.0	14.3	13.7
		25 + 35 + 80	1.79	2.50	5.71	-	-	2.1	10.0	10.7	490	3230	3650	15.0	14.3	13.7
		25 + 50 + 50	2.00	4.00	4.00	-	-	2.1	10.0	10.7	490	3230	3650	15.0	14.3	13.7
		25 + 50 + 60	1.85	3.70	4.44	-	-	2.1	10.0	10.7	490	3230	3650	15.0	14.3	13.7
		25 + 50 + 71	1.71	3.42	4.86	-	-	2.1	10.0	10.7	490	3230	3650	15.0	14.3	13.7
		25 + 50 + 80	1.61	3.23	5.16	-	-	2.1	10.0	10.7	490	3230	3650	15.0	14.3	13.7
		25 + 60 + 60	1.72	4.14	4.14	-	-	2.1	10.0	10.7	490	3230	3650	15.0	14.3	13.7
		25 + 60 + 71	1.60	3.85	4.55	-	-	2.1	10.0	10.7	490	3230	3650	15.0	14.3	13.7
		35 + 35 + 35	3.33	3.33	3.33	-	-	2.1	10.0	10.7	490	3230	3650	15.0	14.3	13.7
		35 + 35 + 50	2.92	2.92	4.17	-	-	2.1	10.0	10.7	490	3230	3650	15.0	14.3	13.7
		35 + 35 + 60	2.69	2.69	4.62	-	-	2.1	10.0	10.7	490	3230	3650	15.0	14.3	13.7
		35 + 35 + 71	2.48	2.48	5.04	-	-	2.1	10.0	10.7	490	3230	3650	15.0	14.3	13.7
35 + 35 + 80	2.33	2.33	5.33	-	-	2.1	10.0	10.7	490	3230	3650	15.0	14.3	13.7		
35 + 50 + 50	2.59	3.70	3.70	-	-	2.1	10.0	10.7	490	3230	3650	15.0	14.3	13.7		
35 + 50 + 60	2.41	3.45	4.14	-	-	2.1	10.0	10.7	490	3230	3650	15.0	14.3	13.7		
35 + 50 + 71	2.24	3.21	4.55	-	-	2.1	10.0	10.7	490	3230	3650	15.0	14.3	13.7		
35 + 60 + 60	2.26	3.87	3.87	-	-	2.1	10.0	10.7	490	3230	3650	15.0	14.3	13.7		
50 + 50 + 50	3.33	3.33	3.33	-	-	2.1	10.0	10.7	490	3230	3650	15.0	14.3	13.7		
50 + 50 + 60	3.13	3.13	3.75	-	-	2.1	10.0	10.7	490	3230	3650	15.0	14.3	13.7		
Cooling operation	4 room	20 + 20 + 20 + 20	2.00	2.00	2.00	2.00	-	2.3	8.0	8.8	485	2020	2330	9.4	9.0	8.6
		20 + 20 + 20 + 25	2.00	2.00	2.00	2.50	-	2.3	8.5	9.4	485	2210	2590	10.3	9.8	9.4
		20 + 20 + 20 + 35	2.00	2.00	2.00	3.50	-	2.3	9.5	10.5	485	2640	3150	12.2	11.7	11.2
		20 + 20 + 20 + 50	1.82	1.82	1.82	4.55	-	2.3	10.0	11.3	485	2950	3650	13.7	13.1	12.5
		20 + 20 + 20 + 60	1.67	1.67	1.67	5.00	-	2.3	10.0	11.3	485	2950	3650	13.7	13.1	12.5
		20 + 20 + 20 + 71	1.53	1.53	1.53	5.42	-	2.3	10.0	11.3	485	2950	3650	13.7	13.1	12.5
		20 + 20 + 20 + 80	1.43	1.43	1.43	5.71	-	2.3	10.0	11.3	485	2950	3650	13.7	13.1	12.5
		20 + 20 + 25 + 25	2.00	2.00	2.50	2.50	-	2.3	9.0	9.9	485	2420	2830	11.2	10.7	10.3
		20 + 20 + 25 + 35	2.00	2.00	2.50	3.50	-	2.3	10.0	11.3	485	2950	3650	13.7	13.1	12.5
		20 + 20 + 25 + 50	1.74	1.74	2.17	4.35	-	2.3	10.0	11.3	485	2950	3650	13.7	13.1	12.5
		20 + 20 + 25 + 60	1.60	1.60	2.00	4.80	-	2.3	10.0	11.3	485	2950	3650	13.7	13.1	12.5
		20 + 20 + 25 + 71	1.47	1.47	1.84	5.22	-	2.3	10.0	11.3	485	2950	3650	13.7	13.1	12.5
		20 + 20 + 25 + 80	1.38	1.38	1.72	5.52	-	2.3	10.0	11.3	485	2950	3650	13.7	13.1	12.5
		20 + 20 + 35 + 35	1.82	1.82	3.18	3.18	-	2.3	10.0	11.3	485	2950	3650	13.7	13.1	12.5
		20 + 20 + 35 + 50	1.60	1.60	2.80	4.00	-	2.3	10.0	11.3	485	2950	3650	13.7	13.1	12.5
		20 + 20 + 35 + 60	1.48	1.48	2.59	4.44	-	2.3	10.0	11.3	485	2950	3650	13.7	13.1	12.5
		20 + 20 + 35 + 71	1.37	1.37	2.40	4.86	-	2.3	10.0	11.3	485	2950	3650	13.7	13.1	12.5
		20 + 20 + 35 + 80	1.29	1.29	2.26	5.16	-	2.3	10.0	11.3	485	2950	3650	13.7	13.1	12.5
		20 + 20 + 50 + 50	1.43	1.43	3.57	3.57	-	2.3	10.0	11.3	485	2950	3650	13.7	13.1	12.5
		20 + 20 + 50 + 60	1.33	1.33	3.33	4.00	-	2.3	10.0	11.3	485	2950	3650	13.7	13.1	12.5
		20 + 20 + 60 + 60	1.25	1.25	3.75	3.75	-	2.3	10.0	11.3	485	2950	3650	13.7	13.1	12.5
		20 + 25 + 25 + 25	2.00	2.50	2.50	2.50	-	2.3	9.5	10.5	485	2640	3150	12.2	11.7	11.2
		20 + 25 + 25 + 35	1.90	2.38	2.38	3.33	-	2.3	10.0	11.1	485	2950	3650	13.7	13.1	12.5
		20 + 25 + 25 + 50	1.67	2.08	2.08	4.17	-	2.3	10.0	11.1	485	2950	3650	13.7	13.1	12.5
		20 + 25 + 25 + 60	1.54	1.92	1.92	4.62	-	2.3	10.0	11.1	485	2950	3650	13.7	13.1	12.5
		20 + 25 + 25 + 71	1.42	1.77	1.77	5.04	-	2.3	10.0	11.1	485	2950	3650	13.7	13.1	12.5
		20 + 25 + 25 + 80	1.33	1.67	1.67	5.33	-	2.3	10.0	11.1	485	2950	3650	13.7	13.1	12.5
		20 + 25 + 35 + 35	1.74	2.17	3.04	3.04	-	2.3	10.0	11.1	485	2950	3650	13.7	13.1	12.5
		20 + 25 + 35 + 50	1.54	1.92	2.69	3.85	-	2.3	10.0	11.1	485	2950	3650	13.7	13.1	12.5
		20 + 25 + 35 + 60	1.43	1.79	2.50	4.29	-	2.3	10.0	11.1	485	2950	3650	13.7	13.1	12.5
		20 + 25 + 35 + 71	1.32	1.66	2.32	4.70	-	2.3	10.0	11.1	485	2950	3650	13.7	13.1	12.5
		20 + 25 + 35 + 80	1.25	1.56	2.19	5.00	-	2.3	10.0	11.1	485	2950	3650	13.7	13.1	12.5
20 + 25 + 50 + 50	1.38	1.72	3.45	3.45	-	2.3	10.0	11.1	485	2950	3650	13.7	13.1	12.5		
20 + 25 + 50 + 60	1.29	1.61	3.23	3.87	-	2.3	10.0	11.1	485	2950	3650	13.7	13.1	12.5		
20 + 35 + 35 + 35	1.60	2.80	2.80	2.80	-	2.3	10.0	11.1	485	2950	3650	13.7	13.1	12.5		
20 + 35 + 35 + 50	1.43	2.50	2.50	3.57	-	2.3	10.0	11.1	485	2950	3650	13.7	13.1	12.5		
20 + 35 + 35 + 60	1.33	2.33	2.33	4.00	-	2.3	10.0	11.1	485	2950	3650	13.7	13.1	12.5		
20 + 35 + 50 + 50	1.29	2.26	3.23	3.23	-	2.3	10.0	11.1	485	2950	3650	13.7	13.1	12.5		
25 + 25 + 25 + 25	2.50	2.50	2.50	2.50	-	2.3	10.0	11.1	485	2950	3650	13.7	13.1	12.5		
25 + 25 + 25 + 35	2.27	2.27	2.27	3.18	-	2.3	10.0	11.1	485	2950	3650	13.7	13.1	12.5		
25 + 25 + 25 + 50	2.00	2.00	2.00	4.00	-	2.3	10.0	11.1	485	2950	3650	13.7	13.1	12.5		



MULTI-SPLIT SYSTEM

Indoor unit combination		Cooling capacity (kW)							Power consumption(W)			Standard current(A)				
		Room cooling capacity					Total capacity		Min.	Standard	Max.	220V	230V	240V		
		A	B	C	D	E	Min.	Standard							Max.	
4 room	25 + 25 + 25 + 60	1.85	1.85	1.85	4.44	-	2.3	10.0	11.1	485	2950	3650	13.7	13.1	12.5	
	25 + 25 + 25 + 71	1.71	1.71	1.71	4.86	-	2.3	10.0	11.1	485	2950	3650	13.7	13.1	12.5	
	25 + 25 + 25 + 80	1.61	1.61	1.61	5.16	-	2.3	10.0	11.1	485	2950	3650	13.7	13.1	12.5	
	25 + 25 + 35 + 35	2.08	2.08	2.92	2.92	-	2.3	10.0	11.1	485	2950	3650	13.7	13.1	12.5	
	25 + 25 + 35 + 50	1.85	1.85	2.59	3.70	-	2.3	10.0	11.1	485	2950	3650	13.7	13.1	12.5	
	25 + 25 + 35 + 60	1.72	1.72	2.41	4.14	-	2.3	10.0	11.1	485	2950	3650	13.7	13.1	12.5	
	25 + 25 + 35 + 71	1.60	1.60	2.24	4.55	-	2.3	10.0	11.1	485	2950	3650	13.7	13.1	12.5	
	25 + 25 + 50 + 50	1.67	1.67	3.33	3.33	-	2.3	10.0	11.1	485	2950	3650	13.7	13.1	12.5	
	25 + 25 + 50 + 60	1.56	1.56	3.13	3.75	-	2.3	10.0	11.1	485	2950	3650	13.7	13.1	12.5	
	25 + 35 + 35 + 35	1.92	2.69	2.69	2.69	-	2.3	10.0	11.1	485	2950	3650	13.7	13.1	12.5	
	25 + 35 + 35 + 50	1.72	2.41	2.41	3.45	-	2.3	10.0	11.1	485	2950	3650	13.7	13.1	12.5	
	25 + 35 + 35 + 60	1.61	2.26	2.26	3.87	-	2.3	10.0	11.1	485	2950	3650	13.7	13.1	12.5	
	25 + 35 + 50 + 50	1.56	2.19	3.13	3.13	-	2.3	10.0	11.1	485	2950	3650	13.7	13.1	12.5	
	35 + 35 + 35 + 35	2.50	2.50	2.50	2.50	-	2.3	10.0	11.1	485	2950	3650	13.7	13.1	12.5	
35 + 35 + 35 + 50	2.26	2.26	2.26	3.23	-	2.3	10.0	11.1	485	2950	3650	13.7	13.1	12.5		
Cooling operation	5 room	20 + 20 + 20 + 20 + 20	2.00	2.00	2.00	2.00	2.00	2.5	10.0	11.5	480	2700	3650	12.4	11.9	11.4
		20 + 20 + 20 + 20 + 25	1.90	1.90	1.90	1.90	2.38	2.5	10.0	11.5	480	2700	3650	12.4	11.9	11.4
		20 + 20 + 20 + 20 + 35	1.74	1.74	1.74	1.74	3.04	2.5	10.0	11.5	480	2700	3650	12.4	11.9	11.4
		20 + 20 + 20 + 20 + 50	1.54	1.54	1.54	1.54	3.85	2.5	10.0	11.5	480	2700	3650	12.4	11.9	11.4
		20 + 20 + 20 + 20 + 60	1.43	1.43	1.43	1.43	4.29	2.5	10.0	11.5	480	2700	3650	12.4	11.9	11.4
		20 + 20 + 20 + 25 + 25	1.82	1.82	1.82	2.27	2.27	2.5	10.0	11.5	480	2700	3650	12.4	11.9	11.4
		20 + 20 + 20 + 25 + 35	1.67	1.67	1.67	2.08	2.92	2.5	10.0	11.5	480	2700	3650	12.4	11.9	11.4
		20 + 20 + 20 + 25 + 50	1.48	1.48	1.48	1.85	3.70	2.5	10.0	11.5	480	2700	3650	12.4	11.9	11.4
		20 + 20 + 20 + 25 + 60	1.38	1.38	1.38	1.72	4.14	2.5	10.0	11.5	480	2700	3650	12.4	11.9	11.4
		20 + 20 + 20 + 35 + 35	1.54	1.54	1.54	2.69	2.69	2.5	10.0	11.5	480	2700	3650	12.4	11.9	11.4
		20 + 20 + 20 + 35 + 50	1.38	1.38	1.38	2.41	3.45	2.5	10.0	11.5	480	2700	3650	12.4	11.9	11.4
		20 + 20 + 20 + 35 + 60	1.29	1.29	1.29	2.26	3.87	2.5	10.0	11.5	480	2700	3650	12.4	11.9	11.4
		20 + 20 + 25 + 25 + 25	1.74	1.74	2.17	2.17	2.17	2.5	10.0	11.5	480	2700	3650	12.4	11.9	11.4
		20 + 20 + 25 + 25 + 35	1.60	1.60	2.00	2.00	2.80	2.5	10.0	11.5	480	2700	3650	12.4	11.9	11.4
	20 + 20 + 25 + 25 + 50	1.43	1.43	1.79	1.79	3.57	2.5	10.0	11.5	480	2700	3650	12.4	11.9	11.4	
	20 + 20 + 25 + 25 + 60	1.33	1.33	1.67	1.67	4.00	2.5	10.0	11.5	480	2700	3650	12.4	11.9	11.4	
	20 + 20 + 25 + 35 + 35	1.48	1.48	1.85	2.59	2.59	2.5	10.0	11.5	480	2700	3650	12.4	11.9	11.4	
	20 + 20 + 25 + 35 + 50	1.33	1.33	1.67	2.33	3.33	2.5	10.0	11.5	480	2700	3650	12.4	11.9	11.4	
	20 + 20 + 25 + 35 + 60	1.25	1.25	1.56	2.19	3.75	2.5	10.0	11.5	480	2700	3650	12.4	11.9	11.4	
	20 + 20 + 35 + 35 + 35	1.38	1.38	2.41	2.41	2.41	2.5	10.0	11.5	480	2700	3650	12.4	11.9	11.4	
	20 + 20 + 35 + 35 + 50	1.25	1.25	2.19	2.19	3.13	2.5	10.0	11.5	480	2700	3650	12.4	11.9	11.4	
	20 + 25 + 25 + 25 + 25	1.67	2.08	2.08	2.08	2.08	2.5	10.0	11.5	480	2700	3650	12.4	11.9	11.4	
	20 + 25 + 25 + 25 + 35	1.54	1.92	1.92	1.92	2.69	2.5	10.0	11.5	480	2700	3650	12.4	11.9	11.4	
	20 + 25 + 25 + 25 + 50	1.38	1.72	1.72	1.72	3.45	2.5	10.0	11.5	480	2700	3650	12.4	11.9	11.4	
	20 + 25 + 25 + 25 + 60	1.29	1.61	1.61	1.61	3.87	2.5	10.0	11.5	480	2700	3650	12.4	11.9	11.4	
	20 + 25 + 25 + 35 + 35	1.43	1.79	1.79	2.50	2.50	2.5	10.0	11.5	480	2700	3650	12.4	11.9	11.4	
	20 + 25 + 25 + 35 + 50	1.29	1.61	1.61	2.26	3.23	2.5	10.0	11.5	480	2700	3650	12.4	11.9	11.4	
	20 + 25 + 35 + 35 + 35	1.33	1.67	2.33	2.33	2.33	2.5	10.0	11.5	480	2700	3650	12.4	11.9	11.4	
	20 + 35 + 35 + 35 + 35	1.25	2.19	2.19	2.19	2.19	2.5	10.0	11.5	480	2700	3650	12.4	11.9	11.4	
	25 + 25 + 25 + 25 + 25	2.00	2.00	2.00	2.00	2.00	2.5	10.0	11.5	480	2700	3650	12.4	11.9	11.4	
25 + 25 + 25 + 25 + 35	1.85	1.85	1.85	1.85	2.59	2.5	10.0	11.5	480	2700	3650	12.4	11.9	11.4		
25 + 25 + 25 + 25 + 50	1.67	1.67	1.67	1.67	3.33	2.5	10.0	11.5	480	2700	3650	12.4	11.9	11.4		
25 + 25 + 25 + 25 + 60	1.56	1.56	1.56	1.56	3.75	2.5	10.0	11.5	480	2700	3650	12.4	11.9	11.4		
25 + 25 + 25 + 35 + 35	1.72	1.72	1.72	2.41	2.41	2.5	10.0	11.5	480	2700	3650	12.4	11.9	11.4		
25 + 25 + 25 + 35 + 50	1.56	1.56	1.56	2.19	3.13	2.5	10.0	11.5	480	2700	3650	12.4	11.9	11.4		
25 + 25 + 35 + 35 + 35	1.61	1.61	2.26	2.26	2.26	2.5	10.0	11.5	480	2700	3650	12.4	11.9	11.4		



COMBINATIONS

SCM40ZS-S Table of Indoor unit combination only with SRK-ZSX type

Indoor unit combination		Heating capacity (kW)					Power consumption(W)			Standard current(A)			
		Room heating capacity		Total capacity			Min.	Standard	Max.	220V	230V	240V	
		A	B	Min.	Standard	Max.							
Heating operation	1*1 room	20	3.0	-	1.3	3.0	3.7	520	750	1070	3.7	3.5	3.4
		25	3.4	-	1.3	3.4	4.2	520	920	1210	4.5	4.3	4.1
		35	4.5	-	1.3	4.5	5.0	520	1210	1450	5.9	5.6	5.4
	2*2 room	20 + 20	2.25	2.25	2.0	4.5	6.3	550	900	1700	4.4	4.2	4.0
		20 + 25	2.36	2.94	2.0	5.3	6.3	550	1150	1700	5.4	5.2	5.0
		20 + 35	2.11	3.69	2.0	5.8	6.3	550	1290	1700	6.0	5.8	5.5
25 + 25		2.90	2.90	2.0	5.8	6.3	550	1290	1700	6.0	5.8	5.5	
	25 + 35	2.42	3.38	2.0	5.8	6.3	550	1290	1700	6.0	5.8	5.5	

The values are for 1 indoor unit (*1) and 2 indoor units (*2) operation.
The same hereinafter.

Indoor unit combination		Cooling capacity (kW)					Power consumption(W)			Standard current(A)				
		Room cooling capacity		Total capacity			Min.	Standard	Max.	220V	230V	240V		
		A	B	Min.	Standard	Max.								
Cooling operation	1 room	20	2.0	-	1.5	2.0	2.8	560	590	880	2.9	2.8	2.7	
		25	2.5	-	1.5	2.5	3.4	560	670	1040	3.3	3.2	3.1	
		35	3.5	-	1.5	3.5	3.9	560	970	1200	4.8	4.6	4.4	
	2 room	20 + 20	2.00	2.00	3.0	4.0	5.7	600	840	1750	4.2	4.0	3.8	
		20 + 25	2.00	2.50	3.0	4.5	5.9	600	1040	2030	5.0	4.8	4.6	
		20 + 35	1.89	3.31	3.0	5.2	5.9	600	1430	2030	6.7	6.4	6.2	
		25 + 25	2.50	2.50	3.0	5.0	5.9	600	1280	2030	6.1	5.8	5.6	
			25 + 35	2.17	3.03	3.0	5.2	5.9	600	1430	2030	6.7	6.4	6.2

SCM40ZS-S Table of Indoor unit combination only with SKM-ZSP type

Indoor unit combination		Heating capacity (kW)					Power consumption(W)			Standard current(A)			
		Room heating capacity		Total capacity			Min.	Standard	Max.	220V	230V	240V	
		A	B	Min.	Standard	Max.							
Heating operation	1 room	20	3.0	-	1.3	3.0	3.5	520	950	1070	4.6	4.4	4.2
		25	3.4	-	1.3	3.4	4.0	520	1020	1210	5.0	4.8	4.6
		35	4.5	-	1.3	4.5	4.8	520	1390	1450	6.8	6.5	6.2
	2 room	20 + 20	2.25	2.25	2.0	4.5	6.1	550	1020	1700	5.0	4.8	4.6
		20 + 25	2.36	2.94	2.0	5.3	6.1	550	1310	1700	6.2	5.9	5.7
		20 + 35	2.11	3.69	2.0	5.8	6.1	550	1400	1700	6.5	6.3	6.0
	25 + 25	2.90	2.90	2.0	5.8	6.1	550	1400	1700	6.5	6.3	6.0	
	25 + 35	2.42	3.38	2.0	5.8	6.1	550	1400	1700	6.5	6.3	6.0	

Indoor unit combination		Cooling capacity (kW)					Power consumption(W)			Standard current(A)				
		Room cooling capacity		Total capacity			Min.	Standard	Max.	220V	230V	240V		
		A	B	Min.	Standard	Max.								
Cooling operation	1 room	20	2.0	-	1.5	2.0	2.7	560	650	880	3.2	3.1	3.0	
		25	2.5	-	1.5	2.5	3.2	560	830	1040	4.1	4.0	3.8	
		35	3.5	-	1.5	3.5	3.7	560	1100	1200	5.5	5.2	5.0	
	2 room	20 + 20	2.00	2.00	3.0	4.0	5.6	600	1050	1750	5.2	5.0	4.8	
		20 + 25	2.00	2.50	3.0	4.5	5.8	600	1300	2030	6.3	6.0	5.8	
		20 + 35	1.89	3.31	3.0	5.2	5.8	600	1600	2030	7.5	7.2	6.9	
		25 + 25	2.50	2.50	3.0	5.0	5.8	600	1420	2030	6.7	6.4	6.2	
			25 + 35	2.17	3.03	3.0	5.2	5.8	600	1600	2030	7.5	7.2	6.9

SCM40ZS-S Table of Indoor unit combination with other indoor unit

Indoor unit combination		Heating capacity (kW)					Power consumption(W)			Standard current(A)			
		Room heating capacity		Total capacity			Min.	Standard	Max.	220V	230V	240V	
		A	B	Min.	Standard	Max.							
Heating operation	1 room	20	3.0	-	1.3	3.0	3.5	520	900	1070	4.4	4.2	4.0
		25	3.4	-	1.3	3.4	4.0	520	1070	1210	5.2	5.0	4.8
		35	4.5	-	1.3	4.5	4.8	520	1340	1450	6.5	6.3	6.0
	2 room	20 + 20	2.25	2.25	2.0	4.5	6.1	550	930	1700	4.5	4.3	4.2
		20 + 25	2.36	2.94	2.0	5.3	6.1	550	1240	1700	5.9	5.6	5.4
		20 + 35	2.11	3.69	2.0	5.8	6.1	550	1330	1700	6.2	5.9	5.7
	25 + 25	2.90	2.90	2.0	5.8	6.1	550	1330	1700	6.2	5.9	5.7	
	25 + 35	2.42	3.38	2.0	5.8	6.1	550	1330	1700	6.2	5.9	5.7	

Indoor unit combination		Cooling capacity (kW)					Power consumption(W)			Standard current(A)				
		Room cooling capacity		Total capacity			Min.	Standard	Max.	220V	230V	240V		
		A	B	Min.	Standard	Max.								
Cooling operation	1 room	20	2.0	-	1.5	2.0	2.7	560	620	880	3.1	3.0	2.8	
		25	2.5	-	1.5	2.5	3.2	560	710	1040	3.5	3.4	3.2	
		35	3.5	-	1.5	3.5	3.7	560	1030	1200	5.1	4.9	4.7	
	2 room	20 + 20	2.00	2.00	3.0	4.0	5.6	600	880	1750	4.4	4.2	4.0	
		20 + 25	2.00	2.50	3.0	4.5	5.8	600	1090	2030	5.3	5.0	4.8	
		20 + 35	1.89	3.31	3.0	5.2	5.8	600	1500	2030	7.0	6.7	6.5	
		25 + 25	2.50	2.50	3.0	5.0	5.8	600	1340	2030	6.4	6.1	5.8	
			25 + 35	2.17	3.03	3.0	5.2	5.8	600	1500	2030	7.0	6.7	6.5



MULTI-SPLIT SYSTEM

SCM45ZS-S Table of Indoor unit combination only with SRK-ZSX type

Indoor unit combination		Heating capacity (kW)					Power consumption(W)			Standard current(A)			
		Room heating capacity		Total capacity			Min.	Standard	Max.	220V	230V	240V	
		A	B	Min.	Standard	Max.							
Heating operation	1 room	20	3.0	-	1.3	3.0	3.7	520	750	1070	3.7	3.5	3.4
		25	3.4	-	1.3	3.4	4.2	520	920	1210	4.5	4.3	4.1
		35	4.5	-	1.3	4.5	5.0	520	1210	1450	5.9	5.6	5.4
Heating operation	2 room	20 + 20	2.25	2.25	2.0	4.5	6.5	550	900	1900	4.4	4.2	4.0
		20 + 25	2.36	2.94	2.0	5.3	6.5	550	1150	1900	5.4	5.2	5.0
		20 + 35	2.18	3.82	2.0	6.0	6.5	550	1500	1900	6.9	6.6	6.3
		25 + 25	3.00	3.00	2.0	6.0	6.5	550	1500	1900	6.9	6.6	6.3
		25 + 35	2.50	3.50	2.0	6.0	6.5	550	1500	1900	6.9	6.6	6.3
		35 + 35	3.00	3.00	2.0	6.0	6.5	550	1500	1900	6.9	6.6	6.3

Indoor unit combination		Cooling capacity (kW)					Power consumption(W)			Standard current(A)			
		Room cooling capacity		Total capacity			Min.	Standard	Max.	220V	230V	240V	
		A	B	Min.	Standard	Max.							
Cooling operation	1 room	20	2.0	-	1.5	2.0	2.8	560	590	880	2.9	2.8	2.7
		25	2.5	-	1.5	2.5	3.4	560	670	1040	3.3	3.2	3.1
		35	3.5	-	1.5	3.5	3.9	560	970	1200	4.8	4.6	4.4
Cooling operation	2 room	20 + 20	2.00	2.00	3.0	4.0	5.7	600	840	1750	4.2	4.0	3.8
		20 + 25	2.00	2.50	3.0	4.5	5.9	600	1040	2030	5.0	4.8	4.6
		20 + 35	2.00	3.50	3.0	5.5	6.3	600	1490	2160	7.0	6.7	6.4
		25 + 25	2.50	2.50	3.0	5.0	6.2	600	1280	2110	6.1	5.8	5.6
		25 + 35	2.42	3.38	3.0	5.8	6.4	600	1740	2200	8.0	7.6	7.3
		35 + 35	2.90	2.90	3.0	5.8	6.4	600	1740	2200	8.0	7.6	7.3

SCM45ZS-S Table of Indoor unit combination only with SKM-ZSP type

Indoor unit combination		Heating capacity (kW)					Power consumption(W)			Standard current(A)			
		Room heating capacity		Total capacity			Min.	Standard	Max.	220V	230V	240V	
		A	B	Min.	Standard	Max.							
Heating operation	1 room	20	3.0	-	1.3	3.0	3.5	520	950	1070	4.6	4.4	4.2
		25	3.4	-	1.3	3.4	4.0	520	1020	1210	5.0	4.8	4.6
		35	4.5	-	1.3	4.5	4.8	520	1390	1450	6.8	6.5	6.2
Heating operation	2 room	20 + 20	2.25	2.25	2.0	4.5	6.3	550	1020	1900	5.0	4.8	4.6
		20 + 25	2.36	2.94	2.0	5.3	6.3	550	1310	1900	6.4	6.1	5.9
		20 + 35	2.18	3.82	2.0	6.0	6.3	550	1600	1900	7.3	7.0	6.7
		25 + 25	3.00	3.00	2.0	6.0	6.3	550	1600	1900	7.3	7.0	6.7
		25 + 35	2.50	3.50	2.0	6.0	6.3	550	1600	1900	7.3	7.0	6.7
		35 + 35	3.00	3.00	2.0	6.0	6.3	550	1600	1900	7.3	7.0	6.7

Indoor unit combination		Cooling capacity (kW)					Power consumption(W)			Standard current(A)			
		Room cooling capacity		Total capacity			Min.	Standard	Max.	220V	230V	240V	
		A	B	Min.	Standard	Max.							
Cooling operation	1 room	20	2.0	-	1.5	2.0	2.7	560	650	880	3.2	3.1	3.0
		25	2.5	-	1.5	2.5	3.2	560	830	1040	4.1	4.0	3.8
		35	3.5	-	1.5	3.5	3.7	560	1100	1200	5.5	5.2	5.0
Cooling operation	2 room	20 + 20	2.00	2.00	3.0	4.0	5.6	600	1050	1750	5.2	5.0	4.8
		20 + 25	2.00	2.50	3.0	4.5	5.8	600	1300	2030	6.3	6.0	5.8
		20 + 35	2.00	3.50	3.0	5.5	6.2	600	1650	2160	7.7	7.4	7.1
		25 + 25	2.50	2.50	3.0	5.0	6.1	600	1380	2110	6.5	6.3	6.0
		25 + 35	2.42	3.38	3.0	5.8	6.3	600	1900	2200	8.7	8.3	8.0
		35 + 35	2.90	2.90	3.0	5.8	6.3	600	1900	2200	8.7	8.3	8.0

SCM45ZS-S Table of Indoor unit combination with other indoor unit

Indoor unit combination		Heating capacity (kW)					Power consumption(W)			Standard current(A)			
		Room heating capacity		Total capacity			Min.	Standard	Max.	220V	230V	240V	
		A	B	Min.	Standard	Max.							
Heating operation	1 room	20	3.0	-	1.3	3.0	3.5	520	900	1070	4.4	4.2	4.0
		25	3.4	-	1.3	3.4	4.0	520	1070	1210	5.2	5.0	4.8
		35	4.5	-	1.3	4.5	4.8	520	1340	1450	6.5	6.3	6.0
Heating operation	2 room	20 + 20	2.25	2.25	2.0	4.5	6.3	550	930	1900	4.5	4.3	4.2
		20 + 25	2.36	2.94	2.0	5.3	6.3	550	1240	1900	6.0	5.8	5.5
		20 + 35	2.18	3.82	2.0	6.0	6.3	550	1550	1900	7.1	6.8	6.5
		25 + 25	3.00	3.00	2.0	6.0	6.3	550	1550	1900	7.1	6.8	6.5
		25 + 35	2.50	3.50	2.0	6.0	6.3	550	1550	1900	7.1	6.8	6.5
		35 + 35	3.00	3.00	2.0	6.0	6.3	550	1550	1900	7.1	6.8	6.5

Indoor unit combination		Cooling capacity (kW)					Power consumption(W)			Standard current(A)			
		Room cooling capacity		Total capacity			Min.	Standard	Max.	220V	230V	240V	
		A	B	Min.	Standard	Max.							
Cooling operation	1 room	20	2.0	-	1.5	2.0	2.7	560	620	880	3.1	3.0	2.8
		25	2.5	-	1.5	2.5	3.2	560	710	1040	3.5	3.4	3.2
		35	3.5	-	1.5	3.5	3.7	560	1030	1200	5.1	4.9	4.7
Cooling operation	2 room	20 + 20	2.00	2.00	3.0	4.0	5.6	600	880	1750	4.4	4.2	4.0
		20 + 25	2.00	2.50	3.0	4.5	5.8	600	1090	2030	5.3	5.0	4.8
		20 + 35	2.00	3.50	3.0	5.5	6.2	600	1560	2160	7.3	7.0	6.7
		25 + 25	2.50	2.50	3.0	5.0	6.1	600	1340	2110	6.4	6.1	5.8
		25 + 35	2.42	3.38	3.0	5.8	6.3	600	1820	2200	8.4	8.0	7.7
		35 + 35	2.90	2.90	3.0	5.8	6.3	600	1820	2200	8.4	8.0	7.7

COMBINATIONS

SCM50ZS-S1 Table of Indoor unit combination only with SRK-ZSX type

Indoor unit combination		Heating capacity (kW)						Power consumption(W)			Standard current(A)			
		Room heating capacity			Total capacity			Min.	Standard	Max.	220V	230V	240V	
		A	B	C	Min.	Standard	Max.							
Heating operation	1 room	20	3.0	-	-	1.4	3.0	3.7	480	820	1100	3.9	3.7	3.6
		25	3.4	-	-	1.4	3.4	4.2	480	980	1240	4.6	4.4	4.2
		35	4.5	-	-	1.4	4.5	5.0	480	1270	1490	6.0	5.7	5.5
		50	5.8	-	-	1.4	5.8	6.2	480	1710	2260	7.9	7.6	7.3
	2 room	20 + 20	2.95	2.95	-	2.0	5.9	7.3	540	1450	2580	6.7	6.4	6.2
		20 + 25	2.67	3.33	-	2.0	6.0	7.3	540	1500	2580	7.0	6.7	6.4
		20 + 35	2.29	4.01	-	2.0	6.3	7.3	540	1580	2580	7.3	7.0	6.7
		20 + 50	1.89	4.71	-	2.0	6.6	7.3	540	1670	2580	7.7	7.4	7.1
		25 + 25	3.05	3.05	-	2.0	6.1	7.3	540	1530	2580	7.1	6.8	6.5
		25 + 35	2.67	3.73	-	2.0	6.4	7.3	540	1610	2580	7.5	7.1	6.8
		25 + 50	2.20	4.40	-	2.0	6.6	7.3	540	1670	2580	7.7	7.4	7.1
	3 room	35 + 35	3.30	3.30	-	2.0	6.6	7.3	540	1670	2580	7.7	7.4	7.1
35 + 50		2.72	3.88	-	2.0	6.6	7.3	540	1670	2580	7.7	7.4	7.1	
20 + 20 + 20		2.00	2.00	2.00	3.0	6.0	7.5	600	1210	2580	5.6	5.4	5.1	
20 + 20 + 25		1.91	1.91	2.38	3.0	6.2	7.5	600	1370	2580	6.4	6.1	5.8	
20 + 20 + 35		1.76	1.76	3.08	3.0	6.6	7.5	600	1520	2580	7.1	6.7	6.5	
20 + 25 + 25		1.83	2.29	2.29	3.0	6.4	7.5	600	1430	2580	6.6	6.3	6.1	
20 + 25 + 35		1.70	2.13	2.98	3.0	6.8	7.5	600	1580	2580	7.3	7.0	6.7	
25 + 25 + 25		2.20	2.20	2.20	3.0	6.6	7.5	600	1520	2580	7.1	6.7	6.5	
25 + 25 + 35	2.06	2.06	2.88	3.0	7.0	7.5	600	1640	2580	7.6	7.3	7.0		

Indoor unit combination		Cooling capacity (kW)						Power consumption(W)			Standard current(A)			
		Room cooling capacity			Total capacity			Min.	Standard	Max.	220V	230V	240V	
		A	B	C	Min.	Standard	Max.							
Cooling operation	1 room	20	2.0	-	-	1.8	2.0	2.8	500	550	900	2.6	2.5	2.4
		25	2.5	-	-	1.8	2.5	3.4	500	720	1070	3.4	3.2	3.1
		35	3.5	-	-	1.8	3.5	3.9	500	1080	1230	5.1	4.8	4.6
		50	5.0	-	-	1.8	5.0	5.5	500	1700	2000	7.9	7.5	7.2
	2 room	20 + 20	2.00	2.00	-	3.0	4.0	5.7	570	910	1800	4.2	4.1	3.9
		20 + 25	1.91	2.39	-	3.0	4.3	5.9	570	1070	1980	5.0	4.8	4.6
		20 + 35	1.82	3.18	-	3.0	5.0	6.2	570	1430	2070	6.6	6.3	6.1
		20 + 50	1.71	4.29	-	3.0	6.0	6.5	570	1960	2150	9.0	8.6	8.2
		25 + 25	2.35	2.35	-	3.0	4.7	6.2	570	1270	2070	5.9	5.6	5.4
		25 + 35	2.21	3.09	-	3.0	5.3	6.5	570	1600	2150	7.4	7.1	6.8
		25 + 50	2.00	4.00	-	3.0	6.0	6.5	570	1960	2150	9.0	8.6	8.2
	3 room	35 + 35	3.00	3.00	-	3.0	6.0	6.5	570	1960	2150	9.0	8.6	8.2
35 + 50		2.47	3.53	-	3.0	6.0	6.5	570	1960	2150	9.0	8.6	8.2	
20 + 20 + 20		1.67	1.67	1.67	3.4	5.0	7.1	690	1050	2150	4.9	4.7	4.5	
20 + 20 + 25		1.60	1.60	2.00	3.4	5.2	7.1	690	1160	2150	5.4	5.1	4.9	
20 + 20 + 35		1.49	1.49	2.61	3.4	5.6	7.1	690	1330	2150	6.2	5.9	5.7	
20 + 25 + 25		1.54	1.93	1.93	3.4	5.4	7.1	690	1260	2150	5.8	5.6	5.4	
20 + 25 + 35		1.45	1.81	2.54	3.4	5.8	7.1	690	1430	2150	6.6	6.3	6.1	
25 + 25 + 25		1.87	1.87	1.87	3.4	5.6	7.1	690	1330	2150	6.2	5.9	5.7	
25 + 25 + 35	1.76	1.76	2.47	3.4	6.0	7.1	690	1490	2150	6.9	6.6	6.3		

SCM50ZS-S1 Table of Indoor unit combination only with SKM-ZSP type

Indoor unit combination		Heating capacity (kW)						Power consumption(W)			Standard current(A)			
		Room heating capacity			Total capacity			Min.	Standard	Max.	220V	230V	240V	
		A	B	C	Min.	Standard	Max.							
Heating operation	1 room	20	3.0	-	-	1.4	3.0	3.5	480	1040	1100	4.9	4.7	4.5
		25	3.4	-	-	1.4	3.4	4.0	480	1200	1240	5.7	5.4	5.2
		35	4.5	-	-	1.4	4.5	4.8	480	1490	1490	7.0	6.7	6.4
		20 + 20	2.95	2.95	-	2.0	5.9	7.0	540	1530	2580	7.1	6.8	6.5
	2 room	20 + 25	2.67	3.33	-	2.0	6.0	7.0	540	1580	2580	7.3	7.0	6.7
		20 + 35	2.29	4.01	-	2.0	6.3	7.0	540	1670	2580	7.7	7.4	7.1
		25 + 25	3.05	3.05	-	2.0	6.1	7.0	540	1610	2580	7.5	7.1	6.8
		25 + 35	2.67	3.73	-	2.0	6.4	7.0	540	1700	2580	7.9	7.5	7.2
		35 + 35	3.30	3.30	-	2.0	6.6	7.0	540	1760	2580	8.1	7.8	7.4
		20 + 20 + 20	2.00	2.00	2.00	3.0	6.0	7.3	600	1360	2580	6.3	6.0	5.8
		20 + 20 + 25	1.91	1.91	2.38	3.0	6.2	7.3	600	1450	2580	6.7	6.4	6.2
	3 room	20 + 20 + 35	1.76	1.76	3.08	3.0	6.6	7.3	600	1620	2580	7.5	7.2	6.9
20 + 25 + 25		1.83	2.29	2.29	3.0	6.4	7.3	600	1530	2580	7.1	6.8	6.5	
20 + 25 + 35		1.70	2.13	2.98	3.0	6.8	7.3	600	1680	2580	7.8	7.5	7.1	
25 + 25 + 25		2.20	2.20	2.20	3.0	6.6	7.3	600	1620	2580	7.5	7.2	6.9	
25 + 25 + 35		2.06	2.06	2.88	3.0	7.0	7.3	600	1750	2580	8.1	7.7	7.4	



MULTI-SPLIT SYSTEM

Indoor unit combination		Cooling capacity (kW)						Power consumption(W)			Standard current(A)			
		Room cooling capacity			Total capacity			Min.	Standard	Max.	220V	230V	240V	
		A	B	C	Min.	Standard	Max.							
Cooling operation	1 room	20	2.0	-	-	1.8	2.0	2.7	500	610	900	2.9	2.8	2.6
		25	2.5	-	-	1.8	2.5	3.2	500	800	1070	3.8	3.6	3.5
		35	3.5	-	-	1.8	3.5	3.7	500	1170	1230	5.5	5.2	5.0
	2 room	20 + 20	2.00	2.00	-	3.0	4.0	5.6	570	1000	1800	4.7	4.5	4.3
		20 + 25	1.91	2.39	-	3.0	4.3	5.8	570	1150	1980	5.4	5.1	4.9
		20 + 35	1.82	3.18	-	3.0	5.0	6.1	570	1530	2070	7.1	6.8	6.5
		25 + 25	2.35	2.35	-	3.0	4.7	6.1	570	1520	2070	7.1	6.8	6.5
		25 + 35	2.21	3.09	-	3.0	5.3	6.3	570	1720	2150	8.0	7.6	7.3
		35 + 35	3.00	3.00	-	3.0	6.0	6.3	570	2050	2150	9.4	9.0	8.6
	3 room	20 + 20 + 20	1.67	1.67	1.67	3.4	5.0	6.9	690	1160	2150	5.4	5.1	4.9
		20 + 20 + 25	1.60	1.60	2.00	3.4	5.2	6.9	690	1250	2150	5.8	5.5	5.3
		20 + 20 + 35	1.49	1.49	2.61	3.4	5.6	6.9	690	1400	2150	6.5	6.2	6.0
		20 + 25 + 25	1.54	1.93	1.93	3.4	5.4	6.9	690	1350	2150	6.3	6.0	5.7
		20 + 25 + 35	1.45	1.81	2.54	3.4	5.8	6.9	690	1500	2150	7.0	6.7	6.4
		25 + 25 + 25	1.87	1.87	1.87	3.4	5.6	6.9	690	1400	2150	6.5	6.2	6.0
25 + 25 + 35		1.76	1.76	2.47	3.4	6.0	6.9	690	1600	2150	7.4	7.1	6.8	

SCM50ZS-S1 Table of Indoor unit combination with other indoor unit

Indoor unit combination		Heating capacity (kW)						Power consumption(W)			Standard current(A)			
		Room heating capacity			Total capacity			Min.	Standard	Max.	220V	230V	240V	
		A	B	C	Min.	Standard	Max.							
Heating operation	1 room	20	3.0	-	-	1.4	3.0	3.5	480	1020	1100	4.8	4.6	4.4
		25	3.4	-	-	1.4	3.4	4.0	480	1180	1240	5.6	5.3	5.1
		35	4.5	-	-	1.4	4.5	4.8	480	1470	1490	6.9	6.6	6.3
		50	5.8	-	-	1.4	5.8	6.0	480	1910	2260	8.8	8.4	8.0
	2 room	20 + 20	2.95	2.95	-	2.0	5.9	7.0	540	1510	2580	7.0	6.7	6.4
		20 + 25	2.67	3.33	-	2.0	6.0	7.0	540	1560	2580	7.2	6.9	6.6
		20 + 35	2.29	4.01	-	2.0	6.3	7.0	540	1650	2580	7.7	7.3	7.0
		20 + 50	1.89	4.71	-	2.0	6.6	7.0	540	1740	2580	8.0	7.7	7.4
		25 + 25	3.05	3.05	-	2.0	6.1	7.0	540	1590	2580	7.4	7.1	6.8
		25 + 35	2.67	3.73	-	2.0	6.4	7.0	540	1680	2580	7.8	7.5	7.1
		25 + 50	2.20	4.40	-	2.0	6.6	7.0	540	1740	2580	8.0	7.7	7.4
	3 room	35 + 35	3.30	3.30	-	2.0	6.6	7.0	540	1740	2580	8.0	7.7	7.4
		35 + 50	2.72	3.88	-	2.0	6.6	7.0	540	1740	2580	8.0	7.7	7.4
		20 + 20 + 20	2.00	2.00	2.00	3.0	6.0	7.3	600	1340	2580	6.2	5.9	5.7
		20 + 20 + 25	1.91	1.91	2.38	3.0	6.2	7.3	600	1430	2580	6.6	6.3	6.1
		20 + 20 + 35	1.76	1.76	3.08	3.0	6.6	7.3	600	1600	2580	7.4	7.1	6.8
		20 + 25 + 25	1.83	2.29	2.29	3.0	6.4	7.3	600	1510	2580	7.0	6.7	6.4
		20 + 25 + 35	1.70	2.13	2.98	3.0	6.8	7.3	600	1660	2580	7.7	7.4	7.1
25 + 25 + 25		2.20	2.20	2.20	3.0	6.6	7.3	600	1600	2580	7.4	7.1	6.8	
25 + 25 + 35	2.06	2.06	2.88	3.0	7.0	7.3	600	1730	2580	8.0	7.7	7.3		

Indoor unit combination		Cooling capacity (kW)						Power consumption(W)			Standard current(A)			
		Room cooling capacity			Total capacity			Min.	Standard	Max.	220V	230V	240V	
		A	B	C	Min.	Standard	Max.							
Cooling operation	1 room	20	2.0	-	-	1.8	2.0	2.7	500	580	900	2.7	2.6	2.5
		25	2.5	-	-	1.8	2.5	3.2	500	760	1070	3.6	3.4	3.3
		35	3.5	-	-	1.8	3.5	3.7	500	1140	1230	5.3	5.1	4.9
		50	5.0	-	-	1.8	5.0	5.3	500	1790	2000	8.3	7.9	7.6
	2 room	20 + 20	2.00	2.00	-	3.0	4.0	5.6	570	950	1800	4.4	4.2	4.1
		20 + 25	1.91	2.39	-	3.0	4.3	5.8	570	1110	1980	5.2	4.9	4.7
		20 + 35	1.82	3.18	-	3.0	5.0	6.1	570	1490	2070	6.9	6.6	6.3
		20 + 50	1.71	4.29	-	3.0	6.0	6.3	570	2040	2150	9.4	9.0	8.6
		25 + 25	2.35	2.35	-	3.0	4.7	6.1	570	1320	2070	6.1	5.9	5.6
		25 + 35	2.21	3.09	-	3.0	5.3	6.3	570	1660	2150	7.7	7.4	7.1
		25 + 50	2.00	4.00	-	3.0	6.0	6.3	570	2040	2150	9.4	9.0	8.6
	3 room	35 + 35	3.00	3.00	-	3.0	6.0	6.3	570	2040	2150	9.4	9.0	8.6
		35 + 50	2.47	3.53	-	3.0	6.0	6.3	570	2040	2150	9.4	9.0	8.6
		20 + 20 + 20	1.67	1.67	1.67	3.4	5.0	6.9	690	1120	2150	5.2	5.0	4.8
		20 + 20 + 25	1.60	1.60	2.00	3.4	5.2	6.9	690	1200	2150	5.6	5.3	5.1
		20 + 20 + 35	1.49	1.49	2.61	3.4	5.6	6.9	690	1370	2150	6.4	6.1	5.8
		20 + 25 + 25	1.54	1.93	1.93	3.4	5.4	6.9	690	1300	2150	6.0	5.8	5.5
		20 + 25 + 35	1.45	1.81	2.54	3.4	5.8	6.9	690	1470	2150	6.8	6.5	6.3
25 + 25 + 25		1.87	1.87	1.87	3.4	5.6	6.9	690	1370	2150	6.4	6.1	5.8	
25 + 25 + 35	1.76	1.76	2.47	3.4	6.0	6.9	690	1540	2150	7.1	6.8	6.5		

COMBINATIONS

SCM60ZM-S1 Table of Indoor unit combination only with SRK-ZSX type

Indoor unit combination		Heating capacity (kW)						Power consumption(W)			Standard current(A)			
		Room heating capacity			Total capacity			Min.	Standard	Max.	220V	230V	240V	
		A	B	C	Min.	Standard	Max.							
Heating operation	1 room	20	3.0	-	-	1.5	3.0	3.7	600	780	1330	3.6	3.4	3.3
		25	3.4	-	-	1.5	3.4	4.2	600	950	1510	4.4	4.2	4.0
		35	4.5	-	-	1.5	4.5	5.0	600	1270	1790	5.8	5.6	5.3
		50	5.8	-	-	1.5	5.8	6.4	600	1730	2310	7.9	7.6	7.3
		60	6.8	-	-	1.5	6.8	7.3	600	2040	2660	9.4	9.0	8.6
	2 room	20+20	3.00	3.00	-	2.1	6.0	7.3	630	1450	2100	6.7	6.4	6.1
		20+25	2.71	3.39	-	2.1	6.1	7.5	630	1520	2550	7.0	6.7	6.4
		20+35	2.36	4.14	-	2.1	6.5	7.6	630	1620	3000	7.4	7.1	6.8
		20+50	2.00	5.00	-	2.1	7.0	7.6	630	1830	3000	8.4	8.0	7.7
		20+60	1.78	5.33	-	2.1	7.1	7.6	630	1860	3000	8.5	8.2	7.8
		25+25	3.15	3.15	-	2.1	6.3	7.6	630	1580	3000	7.3	6.9	6.6
		25+35	2.79	3.91	-	2.1	6.7	7.6	630	1700	3000	7.8	7.5	7.2
		25+50	2.37	4.73	-	2.1	7.1	7.6	630	1860	3000	8.5	8.2	7.8
		25+60	2.09	5.01	-	2.1	7.1	7.6	630	1860	3000	8.5	8.2	7.8
		35+35	3.50	3.50	-	2.1	7.0	7.6	630	1830	3000	8.4	8.0	7.7
		35+50	2.92	4.18	-	2.1	7.1	7.6	630	1860	3000	8.5	8.2	7.8
		35+60	2.62	4.48	-	2.1	7.1	7.6	630	1860	3000	8.5	8.2	7.8
		50+50	3.55	3.55	-	2.1	7.1	7.6	630	1860	3000	8.5	8.2	7.8
		50+60	3.23	3.87	-	2.1	7.1	7.6	630	1860	3000	8.5	8.2	7.8
		3 room	20+20+20	2.27	2.27	2.27	3.2	6.8	7.8	660	1450	3000	6.7	6.4
	20+20+25		2.09	2.09	2.62	3.2	6.8	7.8	660	1450	3000	6.7	6.4	6.1
	20+20+35		1.81	1.81	3.17	3.2	6.8	7.8	660	1450	3000	7.1	6.8	6.6
	20+20+50		1.56	1.56	3.89	3.2	7.0	7.8	660	1620	3000	7.4	7.1	6.8
	20+20+60		1.44	1.44	4.32	3.2	7.2	7.8	660	1780	3000	8.2	7.8	7.5
	20+25+25		1.94	2.43	2.43	3.2	6.8	7.8	660	1450	3000	7.1	6.8	6.6
	20+25+35		1.73	2.16	3.02	3.2	6.9	7.8	660	1500	3000	6.9	6.6	6.3
	20+25+50		1.49	1.87	3.74	3.2	7.1	7.8	660	1670	3000	7.7	7.3	7.0
	20+25+60		1.37	1.71	4.11	3.2	7.2	7.8	660	1780	3000	8.2	7.8	7.5
	20+35+35		1.56	2.72	2.72	3.2	7.0	7.8	660	1620	3000	7.4	7.1	6.8
	20+35+50		1.37	2.40	3.43	3.2	7.2	7.8	660	1780	3000	8.2	7.8	7.5
25+25+25	2.27		2.27	2.27	3.2	6.8	7.8	660	1450	3000	7.1	6.8	6.6	
25+25+35	2.06		2.06	2.88	3.2	7.0	7.8	660	1620	3000	7.4	7.1	6.8	
25+25+50	1.80		1.80	3.60	3.2	7.2	7.8	660	1780	3000	8.2	7.8	7.5	
25+25+60	1.64		1.64	3.93	3.2	7.2	7.8	660	1780	3000	8.2	7.8	7.5	
25+35+35	1.87	2.62	2.62	3.2	7.1	7.8	660	1670	3000	7.7	7.3	7.0		
25+35+50	1.64	2.29	3.27	3.2	7.2	7.8	660	1780	3000	8.2	7.8	7.5		
35+35+35	2.40	2.40	2.40	3.2	7.2	7.8	660	1780	3000	8.2	7.8	7.5		

Indoor unit combination		Cooling capacity (kW)						Power consumption(W)			Standard current(A)			
		Room cooling capacity			Total capacity			Min.	Standard	Max.	220V	230V	240V	
		A	B	C	Min.	Standard	Max.							
Cooling operation	1 room	20	2.0	-	-	1.8	2.0	2.8	500	540	950	2.5	2.4	2.3
		25	2.5	-	-	1.8	2.5	3.4	500	720	1080	3.3	3.2	3.0
		35	3.5	-	-	1.8	3.5	3.9	500	1090	1240	5.0	4.8	4.6
		50	5.0	-	-	1.8	5.0	5.8	500	1780	2100	8.2	7.8	7.5
		60	6.0	-	-	1.8	6.0	6.3	500	2260	2370	10.4	9.9	9.5
	2 room	20+20	2.00	2.00	-	3.0	4.0	5.7	570	750	1750	3.4	3.3	3.2
		20+25	2.00	2.50	-	3.0	4.5	5.9	570	990	1910	4.5	4.3	4.2
		20+35	1.93	3.37	-	3.0	5.3	6.2	570	1550	2110	7.1	6.8	6.5
		20+50	1.89	4.71	-	3.0	6.6	6.9	570	2280	2390	10.5	10.0	9.6
		20+60	1.68	5.03	-	3.0	6.7	6.9	570	2320	2390	10.7	10.2	9.8
		25+25	2.45	2.45	-	3.0	4.9	6.2	570	1270	2110	5.8	5.6	5.3
		25+35	2.42	3.38	-	3.0	5.8	6.5	570	1840	2270	8.4	8.1	7.7
		25+50	2.23	4.47	-	3.0	6.7	6.9	570	2320	2390	10.7	10.2	9.8
		25+60	1.97	4.73	-	3.0	6.7	6.9	570	2320	2390	10.7	10.2	9.8
		35+35	3.30	3.30	-	3.0	6.6	6.9	570	2280	2390	10.5	10.0	9.6
		35+50	2.76	3.94	-	3.0	6.7	6.9	570	2320	2390	10.7	10.2	9.8
		35+60	2.47	4.23	-	3.0	6.7	6.9	570	2320	2390	10.7	10.2	9.8
		50+50	3.35	3.35	-	3.0	6.7	6.9	570	2320	2390	10.7	10.2	9.8
		50+60	3.05	3.65	-	3.0	6.7	6.9	570	2320	2390	10.7	10.2	9.8
		3 room	20+20+20	2.00	2.00	2.00	3.6	6.0	7.5	690	1430	2390	6.6	6.3
	20+20+25		1.85	1.85	2.80	3.6	6.0	7.5	690	1430	2390	6.6	6.3	6.0
	20+20+35		1.60	1.60	2.80	3.6	6.0	7.5	690	1430	2390	6.8	6.5	6.2
	20+20+50		1.40	1.40	3.50	3.6	6.3	7.5	690	1480	2390	6.8	6.5	6.2
	20+20+60		1.28	1.28	3.84	3.6	6.4	7.5	690	1500	2390	6.9	6.6	6.3
	20+25+25		1.69	2.11	2.11	3.6	5.9	7.5	690	1410	2390	6.5	6.2	5.9
	20+25+35		1.53	1.91	2.67	3.6	6.1	7.5	690	1460	2390	6.7	6.4	6.1
	20+25+50		1.35	1.68	3.37	3.6	6.4	7.5	690	1500	2390	6.9	6.6	6.3
	20+25+60		1.26	1.57	3.77	3.6	6.6	7.5	690	1520	2390	7.0	6.7	6.4
	20+35+35		1.40	2.45	2.45	3.6	6.3	7.5	690	1480	2390	6.8	6.5	6.2
	20+35+50		1.26	2.20	3.14	3.6	6.6	7.5	690	1520	2390	7.0	6.7	6.4
25+25+25	2.00		2.00	2.00	3.6	6.0	7.5	690	1430	2390	6.8	6.5	6.2	
25+25+35	1.79		1.79	2.51	3.6	6.1	7.5	690	1460	2390	6.7	6.4	6.1	
25+25+50	1.60		1.60	3.20	3.6	6.4	7.5	690	1500	2390	6.9	6.6	6.3	
25+25+60	1.52		1.52	3.65	3.6	6.7	7.5	690	1540	2390	7.1	6.8	6.5	
25+35+35	1.68	2.36	2.36	3.6	6.4	7.5	690	1500	2390	6.9	6.6	6.3		
25+35+50	1.52	2.13	3.05	3.6	6.7	7.5	690	1540	2390	7.1	6.8	6.5		
35+35+35	2.20	2.20	2.20	3.6	6.6	7.5	690	1520	2390	7.0	6.7	6.4		



MULTI-SPLIT SYSTEM

SCM60ZM-S1 Table of Indoor unit combination with other indoor unit

Indoor unit combination		Heating capacity (kW)						Power consumption(W)			Standard current(A)			
		Room heating capacity			Total capacity			Min.	Standard	Max.	220V	230V	240V	
		A	B	C	Min.	Standard	Max.							
Heating operation	1 room	20	3.0	-	-	1.5	3.0	3.5	600	970	1330	4.5	4.3	4.1
		25	3.4	-	-	1.5	3.4	4.0	600	1140	1510	5.2	5.0	4.8
		35	4.5	-	-	1.5	4.5	4.8	600	1480	1790	6.8	6.5	6.2
		50	5.8	-	-	1.5	5.8	6.1	600	1960	2310	9.0	8.6	8.2
		60	6.8	-	-	1.5	6.8	7.0	600	2250	2660	10.3	9.9	9.5
	2 room	20+20	3.00	3.00	-	2.1	6.0	7.0	630	1520	2100	7.0	6.7	6.4
		20+25	2.71	3.39	-	2.1	6.1	7.2	630	1600	2550	7.3	7.0	6.7
		20+35	2.36	4.14	-	2.1	6.5	7.3	630	1710	3000	7.9	7.5	7.2
		20+50	2.00	5.00	-	2.1	7.0	7.3	630	1940	3000	8.9	8.5	8.2
		20+60	1.78	5.33	-	2.1	7.1	7.3	630	1980	3000	9.1	8.7	8.3
		25+25	3.15	3.15	-	2.1	6.3	7.3	630	1660	3000	7.6	7.3	7.0
		25+35	2.79	3.91	-	2.1	6.7	7.3	630	1790	3000	8.2	7.9	7.5
		25+50	2.37	4.73	-	2.1	7.1	7.3	630	1980	3000	9.1	8.7	8.3
		25+60	2.09	5.01	-	2.1	7.1	7.3	630	1980	3000	9.1	8.7	8.3
		35+35	3.50	3.50	-	2.1	7.0	7.3	630	1940	3000	8.9	8.5	8.2
		35+50	2.92	4.18	-	2.1	7.1	7.3	630	1980	3000	9.1	8.7	8.3
		35+60	2.62	4.48	-	2.1	7.1	7.3	630	1980	3000	9.1	8.7	8.3
		50+50	3.55	3.55	-	2.1	7.1	7.3	630	1980	3000	9.1	8.7	8.3
50+60	3.23	3.87	-	2.1	7.1	7.3	630	1980	3000	9.1	8.7	8.3		
3 room	20+20+20	2.27	2.27	2.27	3.2	6.8	7.6	660	1540	3000	7.1	6.8	6.5	
	20+20+25	2.09	2.09	2.62	3.2	6.8	7.6	660	1540	3000	7.1	6.8	6.5	
	20+20+35	1.81	1.81	3.17	3.2	6.8	7.6	660	1540	3000	7.1	6.8	6.5	
	20+20+50	1.56	1.56	3.89	3.2	7.0	7.6	660	1730	3000	7.9	7.6	7.3	
	20+20+60	1.44	1.44	4.32	3.2	7.2	7.6	660	1900	3000	8.7	8.3	8.0	
	20+25+25	1.94	2.43	2.43	3.2	6.8	7.6	660	1540	3000	7.1	6.8	6.5	
	20+25+35	1.73	2.16	3.02	3.2	6.9	7.6	660	1590	3000	7.3	7.0	6.7	
	20+25+50	1.49	1.87	3.74	3.2	7.1	7.6	660	1780	3000	8.2	7.8	7.5	
	20+25+60	1.37	1.71	4.11	3.2	7.2	7.6	660	1900	3000	8.7	8.3	8.0	
	20+35+35	1.56	2.72	2.72	3.2	7.0	7.6	660	1730	3000	7.9	7.6	7.3	
	20+35+50	1.37	2.40	3.43	3.2	7.2	7.6	660	1900	3000	8.7	8.3	8.0	
	25+25+25	2.27	2.27	2.27	3.2	6.8	7.6	660	1540	3000	7.1	6.8	6.5	
	25+25+35	2.06	2.06	2.88	3.2	7.0	7.6	660	1730	3000	7.9	7.6	7.3	
	25+25+50	1.80	1.80	3.60	3.2	7.2	7.6	660	1900	3000	8.7	8.3	8.0	
	25+25+60	1.64	1.64	3.93	3.2	7.2	7.6	660	1900	3000	8.7	8.3	8.0	
25+35+35	1.87	2.62	2.62	3.2	7.1	7.6	660	1780	3000	8.2	7.8	7.5		
25+35+50	1.64	2.29	3.27	3.2	7.2	7.6	660	1900	3000	8.7	8.3	8.0		
35+35+35	2.40	2.40	2.40	3.2	7.2	7.6	660	1900	3000	8.7	8.3	8.0		

Indoor unit combination		Cooling capacity (kW)						Power consumption(W)			Standard current(A)			
		Room cooling capacity			Total capacity			Min.	Standard	Max.	220V	230V	240V	
		A	B	C	Min.	Standard	Max.							
Cooling operation	1 room	20	2.0	-	-	1.8	2.0	2.7	500	570	950	2.6	2.5	2.4
		25	2.5	-	-	1.8	2.5	3.2	500	760	1080	3.5	3.3	3.2
		35	3.5	-	-	1.8	3.5	3.7	500	1150	1240	5.3	5.1	4.8
		50	5.0	-	-	1.8	5.0	5.6	500	1860	2100	8.5	8.2	7.8
		60	6.0	-	-	1.8	6.0	6.1	500	2350	2370	10.8	10.3	9.9
	2 room	20+20	2.00	2.00	-	3.0	4.0	5.6	570	800	1750	3.7	3.5	3.4
		20+25	2.00	2.50	-	3.0	4.5	5.8	570	1050	1910	4.8	4.6	4.4
		20+35	1.93	3.37	-	3.0	5.3	6.1	570	1620	2110	7.4	7.1	6.8
		20+50	1.89	4.71	-	3.0	6.6	6.8	570	2330	2390	10.7	10.2	9.8
		20+60	1.68	5.03	-	3.0	6.7	6.8	570	2370	2390	10.9	10.4	10.0
		25+25	2.45	2.45	-	3.0	4.9	6.1	570	1340	2110	6.2	5.9	5.6
		25+35	2.42	3.38	-	3.0	5.8	6.4	570	1920	2270	8.8	8.4	8.1
		25+50	2.23	4.47	-	3.0	6.7	6.8	570	2370	2390	10.9	10.4	10.0
		25+60	1.97	4.73	-	3.0	6.7	6.8	570	2370	2390	10.9	10.4	10.0
		35+35	3.30	3.30	-	3.0	6.6	6.8	570	2330	2390	10.7	10.2	9.8
		35+50	2.76	3.94	-	3.0	6.7	6.8	570	2370	2390	10.9	10.4	10.0
		35+60	2.47	4.23	-	3.0	6.7	6.8	570	2370	2390	10.9	10.4	10.0
		50+50	3.35	3.35	-	3.0	6.7	6.8	570	2370	2390	10.9	10.4	10.0
50+60	3.05	3.65	-	3.0	6.7	6.8	570	2370	2390	10.9	10.4	10.0		
3 room	20+20+20	2.00	2.00	2.00	3.6	6.0	7.3	690	1470	2390	6.7	6.5	6.2	
	20+20+25	1.85	1.85	2.31	3.6	6.0	7.3	690	1470	2390	6.7	6.5	6.2	
	20+20+35	1.60	1.60	2.80	3.6	6.0	7.3	690	1470	2390	6.7	6.5	6.2	
	20+20+50	1.40	1.40	3.50	3.6	6.3	7.3	690	1520	2390	7.0	6.7	6.4	
	20+20+60	1.28	1.28	3.84	3.6	6.4	7.3	690	1540	2390	7.1	6.8	6.5	
	20+25+25	1.69	2.11	2.11	3.6	5.9	7.3	690	1450	2390	6.7	6.4	6.1	
	20+25+35	1.53	1.91	2.67	3.6	6.1	7.3	690	1500	2390	6.9	6.6	6.3	
	20+25+50	1.35	1.68	3.37	3.6	6.4	7.3	690	1540	2390	7.1	6.8	6.5	
	20+25+60	1.26	1.57	3.77	3.6	6.6	7.3	690	1560	2390	7.2	6.9	6.6	
	20+35+35	1.40	2.45	2.45	3.6	6.3	7.3	690	1520	2390	7.0	6.7	6.4	
	20+35+50	1.26	2.20	3.14	3.6	6.6	7.3	690	1560	2390	7.2	6.9	6.6	
	25+25+25	2.00	2.00	2.00	3.6	6.0	7.3	690	1470	2390	6.7	6.5	6.2	
	25+25+35	1.79	1.79	2.51	3.6	6.1	7.3	690	1500	2390	6.9	6.6	6.3	
	25+25+50	1.60	1.60	3.20	3.6	6.4	7.3	690	1540	2390	7.1	6.8	6.5	
	25+25+60	1.52	1.52	3.65	3.6	6.7	7.3	690	1580	2390	7.3	6.9	6.6	
25+35+35	1.68	2.36	2.36	3.6	6.4	7.3	690	1540	2390	7.1	6.8	6.5		
25+35+50	1.52	2.13	3.05	3.6	6.7	7.3	690	1580	2390	7.3	6.9	6.6		
35+35+35	2.20	2.20	2.20	3.6	6.6	7.3	690	1560	2390	7.2	6.9	6.6		

COMBINATIONS

SCM71ZM-S1 Table of Indoor unit combination only with SRK-ZSX type

Indoor unit combination		Heating capacity (kW)							Power consumption(W)			Standard current(A)		
		Room heating capacity				Total capacity			Min.	Standard	Max.	220V	230V	240V
		A	B	C	D	Min.	Standard	Max.						
1 room	20	3.0	-	-	-	1.5	3.0	3.7	600	840	1330	3.9	3.7	3.5
	25	3.4	-	-	-	1.5	3.4	4.2	600	1000	1510	4.6	4.4	4.2
	35	4.5	-	-	-	1.5	4.5	5.0	600	1330	1790	6.1	5.8	5.6
	50	5.8	-	-	-	1.5	5.8	6.5	600	1780	2310	8.2	7.8	7.5
2 room	60	6.8	-	-	-	1.5	6.8	7.5	600	2100	2660	9.6	9.2	8.8
	20 + 20	2.70	2.70	-	-	2.1	5.4	7.4	630	1340	1870	6.2	5.9	5.6
	20 + 25	2.62	3.28	-	-	2.1	5.9	7.7	630	1530	2130	7.0	6.7	6.4
	20 + 35	2.51	4.39	-	-	2.1	6.9	8.3	630	1910	2650	8.8	8.4	8.0
	20 + 50	2.34	5.86	-	-	2.1	8.2	8.7	630	2430	3350	11.2	10.7	10.2
	20 + 60	2.05	6.15	-	-	2.1	8.2	8.7	630	2430	3350	11.2	10.7	10.2
	25 + 25	3.20	3.20	-	-	2.1	6.4	8.1	630	1700	2480	7.8	7.5	7.2
	25 + 35	3.08	4.32	-	-	2.1	7.4	8.6	630	2090	2910	9.6	9.2	8.8
	25 + 50	2.73	5.47	-	-	2.1	8.2	8.7	630	2430	3350	11.2	10.7	10.2
	25 + 60	2.41	5.79	-	-	2.1	8.2	8.7	630	2430	3350	11.2	10.7	10.2
	35 + 35	4.10	4.10	-	-	2.1	8.2	8.7	630	2430	3350	11.2	10.7	10.2
	35 + 50	3.38	4.82	-	-	2.1	8.2	8.7	630	2430	3350	11.2	10.7	10.2
	35 + 60	3.02	5.18	-	-	2.1	8.2	8.7	630	2430	3350	11.2	10.7	10.2
	50 + 50	4.10	4.10	-	-	2.1	8.2	8.7	630	2430	3350	11.2	10.7	10.2
	50 + 60	3.73	4.47	-	-	2.1	8.2	8.7	630	2430	3350	11.2	10.7	10.2
	60 + 60	4.10	4.10	-	-	2.1	8.2	8.7	630	2430	3350	11.2	10.7	10.2
3 room	20 + 20 + 20	2.57	2.57	2.57	-	3.2	7.7	9.1	660	1830	3350	8.4	8.0	7.7
	20 + 20 + 25	2.46	2.46	3.08	-	3.2	8.0	9.1	660	1930	3350	8.9	8.5	8.1
	20 + 20 + 35	2.24	2.24	3.92	-	3.2	8.4	9.1	660	2060	3350	9.5	9.0	8.7
	20 + 20 + 50	1.87	1.87	4.67	-	3.2	8.4	9.1	660	2060	3350	9.5	9.0	8.7
	20 + 20 + 60	1.68	1.68	5.04	-	3.2	8.4	9.1	660	2060	3350	9.5	9.0	8.7
	20 + 25 + 25	2.34	2.93	2.93	-	3.2	8.2	9.1	660	1990	3350	9.1	8.7	8.4
	20 + 25 + 35	2.10	2.63	3.68	-	3.2	8.4	9.1	660	2060	3350	9.5	9.0	8.7
	20 + 25 + 50	1.77	2.21	4.42	-	3.2	8.4	9.1	660	2060	3350	9.5	9.0	8.7
	20 + 25 + 60	1.60	2.00	4.80	-	3.2	8.4	9.1	660	2060	3350	9.5	9.0	8.7
	20 + 35 + 35	1.87	3.27	3.27	-	3.2	8.4	9.1	660	2060	3350	9.5	9.0	8.7
	20 + 35 + 50	1.60	2.80	4.00	-	3.2	8.4	9.1	660	2060	3350	9.5	9.0	8.7
	20 + 35 + 60	1.46	2.56	4.38	-	3.2	8.4	9.1	660	2060	3350	9.5	9.0	8.7
	20 + 50 + 50	1.40	3.50	3.50	-	3.2	8.4	9.1	660	2060	3350	9.5	9.0	8.7
	25 + 25 + 25	2.80	2.80	2.80	-	3.2	8.4	9.1	660	2060	3350	9.5	9.0	8.7
	25 + 25 + 35	2.47	2.47	3.46	-	3.2	8.4	9.1	660	2060	3350	9.5	9.0	8.7
	25 + 25 + 50	2.10	2.10	4.20	-	3.2	8.4	9.1	660	2060	3350	9.5	9.0	8.7
	25 + 25 + 60	1.91	1.91	4.58	-	3.2	8.4	9.1	660	2060	3350	9.5	9.0	8.7
	25 + 35 + 35	2.21	3.09	3.09	-	3.2	8.4	9.1	660	2060	3350	9.5	9.0	8.7
	25 + 35 + 50	1.91	2.67	3.82	-	3.2	8.4	9.1	660	2060	3350	9.5	9.0	8.7
	25 + 35 + 60	1.75	2.45	4.20	-	3.2	8.4	9.1	660	2060	3350	9.5	9.0	8.7
25 + 50 + 50	1.68	3.36	3.36	-	3.2	8.4	9.1	660	2060	3350	9.5	9.0	8.7	
35 + 35 + 35	2.80	2.80	2.80	-	3.2	8.4	9.1	660	2060	3350	9.5	9.0	8.7	
35 + 35 + 50	2.45	2.45	3.50	-	3.2	8.4	9.1	660	2060	3350	9.5	9.0	8.7	
4 room	20 + 20 + 20 + 20	2.10	2.10	2.10	2.10	3.6	8.4	9.4	800	1960	3350	9.0	8.6	8.2
	20 + 20 + 20 + 25	1.98	1.98	1.98	2.47	3.6	8.4	9.4	800	1960	3350	9.0	8.6	8.2
	20 + 20 + 20 + 35	1.79	1.79	1.79	3.13	3.6	8.5	9.4	800	1980	3350	9.1	8.7	8.3
	20 + 20 + 20 + 50	1.56	1.56	1.56	3.91	3.6	8.6	9.4	800	2000	3350	9.2	8.8	8.4
	20 + 20 + 20 + 60	1.43	1.43	1.43	4.30	3.6	8.6	9.4	800	2000	3350	9.2	8.8	8.4
	20 + 20 + 25 + 25	1.89	1.89	2.36	2.36	3.6	8.5	9.4	800	1980	3350	9.1	8.7	8.3
	20 + 20 + 25 + 35	1.70	1.70	2.13	2.98	3.6	8.5	9.4	800	1980	3350	9.1	8.7	8.3
	20 + 20 + 25 + 50	1.50	1.50	1.87	3.74	3.6	8.6	9.4	800	2000	3350	9.2	8.8	8.4
	20 + 20 + 25 + 60	1.38	1.38	1.72	4.13	3.6	8.6	9.4	800	2000	3350	9.2	8.8	8.4
	20 + 20 + 35 + 35	1.56	1.56	2.74	2.74	3.6	8.6	9.4	800	2000	3350	9.2	8.8	8.4
	20 + 20 + 35 + 50	1.38	1.38	2.41	3.44	3.6	8.6	9.4	800	2000	3350	9.2	8.8	8.4
	20 + 25 + 25 + 25	1.79	2.24	2.24	2.24	3.6	8.5	9.4	800	1980	3350	9.1	8.7	8.3
	20 + 25 + 25 + 35	1.64	2.05	2.05	2.87	3.6	8.6	9.4	800	2000	3350	9.2	8.8	8.4
	20 + 25 + 25 + 50	1.43	1.79	1.79	3.58	3.6	8.6	9.4	800	2000	3350	9.2	8.8	8.4
	20 + 25 + 35 + 35	1.50	1.87	2.62	2.62	3.6	8.6	9.4	800	2000	3350	9.2	8.8	8.4
	20 + 35 + 35 + 35	1.38	2.41	2.41	2.41	3.6	8.6	9.4	800	2000	3350	9.2	8.8	8.4
25 + 25 + 25 + 25	2.13	2.13	2.13	2.13	3.6	8.5	9.4	800	1980	3350	9.1	8.7	8.3	
25 + 25 + 25 + 35	1.95	1.95	1.95	2.74	3.6	8.6	9.4	800	2000	3350	9.2	8.8	8.4	
25 + 25 + 25 + 50	1.72	1.72	1.72	3.44	3.6	8.6	9.4	800	2000	3350	9.2	8.8	8.4	
25 + 25 + 35 + 35	1.79	1.79	2.51	2.51	3.6	8.6	9.4	800	2000	3350	9.2	8.8	8.4	

Indoor unit combination		Cooling capacity (kW)							Power consumption(W)			Standard current(A)		
		Room cooling capacity				Total capacity			Min.	Standard	Max.	220V	230V	240V
		A	B	C	D	Min.	Standard	Max.						
1 room	20	2.0	-	-	-	1.8	2.0	2.8	480	500	950	2.3	2.2	2.1
	25	2.5	-	-	-	1.8	2.5	3.4	480	680	1080	3.1	3.0	2.9
	35	3.5	-	-	-	1.8	3.5	3.9	480	1010	1240	4.6	4.4	4.3
	50	5.0	-	-	-	1.8	5.0	6.1	480	1530	2100	7.0	6.7	6.4
2 room	60	6.0	-	-	-	1.8	6.0	7.0	480	1880	2700	8.6	8.3	7.9
	20 + 20	2.00	2.00	-	-	3.0	4.0	6.1	550	830	1910	3.8	3.6	3.5
	20 + 25	2.00	2.50	-	-	3.0	4.5	6.4	550	1030	2060	4.7	4.5	4.3
	20 + 35	2.00	3.50	-	-	3.0	5.5	6.9	550	1390	2320	6.4	6.1	5.9
	20 + 50	1.94	4.86	-	-	3.0	6.8	7.7	550	1860	2750	8.5	8.2	7.8
	20 + 60	1.70	5.10	-	-	3.0	6.8	7.7	550	1860	2750	8.5	8.2	7.8



MULTI-SPLIT SYSTEM

Indoor unit combination		Cooling capacity (kW)							Power consumption(W)			Standard current(A)			
		Room cooling capacity				Total capacity			Min.	Standard	Max.	220V	230V	240V	
		A	B	C	D	Min.	Standard	Max.							
Cooling operation	2 room	25 + 25	2.50	2.50	-	-	3.0	5.0	6.8	550	1190	2270	5.5	5.2	5.0
		25 + 35	2.46	3.44	-	-	3.0	5.9	7.2	550	1560	2470	7.2	6.9	6.6
		25 + 50	2.27	4.53	-	-	3.0	6.8	7.7	550	1860	2750	8.5	8.2	7.8
		25 + 60	2.00	4.80	-	-	3.0	6.8	7.7	550	1860	2750	8.5	8.2	7.8
		35 + 35	3.40	3.40	-	-	3.0	6.8	7.6	550	1860	2680	8.5	8.2	7.8
		35 + 50	2.80	4.00	-	-	3.0	6.8	7.7	550	1860	2750	8.5	8.2	7.8
		35 + 60	2.51	4.29	-	-	3.0	6.8	7.7	550	1860	2750	8.5	8.2	7.8
		50 + 50	3.40	3.40	-	-	3.0	6.8	7.7	550	1860	2750	8.5	8.2	7.8
	50 + 60	3.09	3.71	-	-	3.0	6.8	7.7	550	1860	2750	8.5	8.2	7.8	
	60 + 60	3.40	3.40	-	-	3.0	6.8	7.7	550	1860	2750	8.5	8.2	7.8	
	3 room	20 + 20 + 20	2.00	2.00	2.00	-	3.7	6.0	8.2	670	1300	2750	6.0	5.7	5.5
		20 + 20 + 25	2.00	2.00	2.50	-	3.7	6.5	8.2	670	1450	2750	6.7	6.4	6.1
		20 + 20 + 35	1.84	1.84	3.22	-	3.7	6.9	8.2	670	1670	2750	7.7	7.3	7.0
		20 + 20 + 50	1.53	1.53	3.83	-	3.7	6.9	8.2	670	1670	2750	7.7	7.3	7.0
		20 + 20 + 60	1.38	1.38	4.14	-	3.7	6.9	8.2	670	1670	2750	7.7	7.3	7.0
		20 + 25 + 25	1.94	2.43	2.43	-	3.7	6.8	8.2	670	1610	2750	7.4	7.1	6.8
		20 + 25 + 35	1.73	2.16	3.02	-	3.7	6.9	8.2	670	1670	2750	7.7	7.3	7.0
		20 + 25 + 50	1.45	1.82	3.63	-	3.7	6.9	8.2	670	1670	2750	7.7	7.3	7.0
		20 + 25 + 60	1.31	1.64	3.94	-	3.7	6.9	8.2	670	1670	2750	7.7	7.3	7.0
		25 + 35 + 35	1.53	2.68	2.68	-	3.7	6.9	8.2	670	1670	2750	7.7	7.3	7.0
		20 + 35 + 50	1.31	2.30	3.29	-	3.7	6.9	8.2	670	1670	2750	7.7	7.3	7.0
		20 + 35 + 60	1.20	2.10	3.60	-	3.7	6.9	8.2	670	1670	2750	7.7	7.3	7.0
		20 + 50 + 50	1.15	2.88	2.88	-	3.7	6.9	8.2	670	1670	2750	7.7	7.3	7.0
		25 + 25 + 25	2.30	2.30	2.30	-	3.7	6.9	8.2	670	1670	2750	7.7	7.3	7.0
		25 + 25 + 35	2.03	2.03	2.84	-	3.7	6.9	8.2	670	1670	2750	7.7	7.3	7.0
		25 + 25 + 50	1.73	1.73	3.45	-	3.7	6.9	8.2	670	1670	2750	7.7	7.3	7.0
		25 + 25 + 60	1.57	1.57	3.76	-	3.7	6.9	8.2	670	1670	2750	7.7	7.3	7.0
		25 + 35 + 35	1.82	2.54	2.54	-	3.7	6.9	8.2	670	1670	2750	7.7	7.3	7.0
25 + 35 + 50		1.57	2.20	3.14	-	3.7	6.9	8.2	670	1670	2750	7.7	7.3	7.0	
25 + 35 + 60		1.44	2.01	3.45	-	3.7	6.9	8.2	670	1670	2750	7.7	7.3	7.0	
25 + 50 + 50	1.38	2.76	2.76	-	3.7	6.9	8.2	670	1670	2750	7.7	7.3	7.0		
35 + 35 + 35	2.30	2.30	2.30	-	3.7	6.9	8.2	670	1670	2750	7.7	7.3	7.0		
35 + 35 + 50	2.01	2.01	2.88	-	3.7	6.9	8.2	670	1670	2750	7.7	7.3	7.0		
4 room	20 + 20 + 20 + 20	1.73	1.73	1.73	1.73	4.4	6.9	8.8	890	1550	2750	7.1	6.8	6.5	
	20 + 20 + 20 + 25	1.62	1.62	1.62	2.03	4.4	6.9	8.8	890	1550	2750	7.1	6.8	6.5	
	20 + 20 + 20 + 35	1.49	1.49	1.49	2.62	4.4	7.1	8.8	890	1580	2750	7.3	6.9	6.6	
	20 + 20 + 20 + 50	1.29	1.29	1.29	3.23	4.4	7.1	8.8	890	1580	2750	7.3	6.9	6.6	
	20 + 20 + 20 + 60	1.18	1.18	1.18	3.55	4.4	7.1	8.8	890	1580	2750	7.3	6.9	6.6	
	20 + 20 + 25 + 25	1.53	1.53	1.92	1.92	4.4	6.9	8.8	890	1550	2750	7.1	6.8	6.5	
	20 + 20 + 25 + 35	1.42	1.42	1.78	2.49	4.4	7.1	8.8	890	1580	2750	7.3	6.9	6.6	
	20 + 20 + 25 + 50	1.23	1.23	1.54	3.09	4.4	7.1	8.8	890	1580	2750	7.3	6.9	6.6	
	20 + 20 + 25 + 60	1.14	1.14	1.42	3.41	4.4	7.1	8.8	890	1580	2750	7.3	6.9	6.6	
	20 + 20 + 35 + 35	1.29	1.29	2.26	2.26	4.4	7.1	8.8	890	1580	2750	7.3	6.9	6.6	
	20 + 20 + 35 + 50	1.14	1.14	1.99	2.84	4.4	7.1	8.8	890	1580	2750	7.3	6.9	6.6	
	20 + 25 + 25 + 25	1.49	1.87	1.87	1.87	4.4	7.1	8.8	890	1580	2750	7.3	6.9	6.6	
	20 + 25 + 25 + 35	1.35	1.69	1.69	2.37	4.4	7.1	8.8	890	1580	2750	7.3	6.9	6.6	
	20 + 25 + 25 + 50	1.18	1.48	1.48	2.96	4.4	7.1	8.8	890	1580	2750	7.3	6.9	6.6	
	20 + 25 + 35 + 35	1.23	1.54	2.16	2.16	4.4	7.1	8.8	890	1580	2750	7.3	6.9	6.6	
	20 + 35 + 35 + 35	1.14	1.99	1.99	1.99	4.4	7.1	8.8	890	1580	2750	7.3	6.9	6.6	
25 + 25 + 25 + 25	1.78	1.78	1.78	1.78	4.4	7.1	8.8	890	1580	2750	7.3	6.9	6.6		
25 + 25 + 25 + 35	1.61	1.61	1.61	2.26	4.4	7.1	8.8	890	1580	2750	7.3	6.9	6.6		
25 + 25 + 25 + 50	1.42	1.42	1.42	2.84	4.4	7.1	8.8	890	1580	2750	7.3	6.9	6.6		
25 + 25 + 35 + 35	1.48	1.48	2.07	2.07	4.4	7.1	8.8	890	1580	2750	7.3	6.9	6.6		

SCM71ZM-S1 Table of Indoor unit combination with other indoor unit

Indoor unit combination		Heating capacity (kW)							Power consumption(W)			Standard current(A)			
		Room heating capacity				Total capacity			Min.	Standard	Max.	220V	230V	240V	
		A	B	C	D	Min.	Standard	Max.							
Heating operation	1 room	20	3.0	-	-	-	1.5	3.0	3.5	600	1060	1330	4.9	4.7	4.5
		25	3.4	-	-	-	1.5	3.4	4.0	600	1220	1510	5.6	5.4	5.1
		35	4.5	-	-	-	1.5	4.5	4.8	600	1510	1790	6.9	6.6	6.4
		50	5.8	-	-	-	1.5	5.8	6.2	600	1950	2310	9.0	8.6	8.2
		60	6.8	-	-	-	1.5	6.8	7.1	600	2240	2660	10.3	9.8	9.4
	2 room	20 + 20	2.70	2.70	-	-	2.1	5.4	7.0	630	1370	1870	6.3	6.0	5.8
		20 + 25	2.62	3.28	-	-	2.1	5.9	7.3	630	1560	2130	7.2	6.9	6.6
		20 + 35	2.51	4.39	-	-	2.1	6.9	7.9	630	1950	2650	9.0	8.6	8.2
		20 + 50	2.34	5.86	-	-	2.1	8.2	8.3	630	2490	3350	11.4	10.9	10.5
		20 + 60	2.05	6.15	-	-	2.1	8.2	8.3	630	2490	3350	11.4	10.9	10.5
		25 + 25	3.20	3.20	-	-	2.1	6.4	7.7	630	1740	2480	8.0	7.6	7.3
		25 + 35	3.08	4.32	-	-	2.1	7.4	8.2	630	2130	2910	9.8	9.4	9.0
		25 + 50	2.73	5.47	-	-	2.1	8.2	8.3	630	2490	3350	11.4	10.9	10.5
		25 + 60	2.41	5.79	-	-	2.1	8.2	8.3	630	2490	3350	11.4	10.9	10.5
		35 + 35	4.10	4.10	-	-	2.1	8.2	8.3	630	2490	3350	11.4	10.9	10.5
		35 + 50	3.38	4.82	-	-	2.1	8.2	8.3	630	2490	3350	11.4	10.9	10.5
35 + 60	3.02	5.18	-	-	2.1	8.2	8.3	630	2490	3350	11.4	10.9	10.5		

COMBINATIONS

Indoor unit combination		Heating capacity (kW)							Power consumption(W)			Standard current(A)				
		Room heating capacity				Total capacity			Min.	Standard	Max.	220V	230V	240V		
		A	B	C	D	Min.	Standard	Max.								
Heating operation	2 room	50 + 50	4.10	4.10	-	-	2.1	8.2	8.3	630	2490	3350	11.4	10.9	10.5	
		50 + 60	3.73	4.47	-	-	2.1	8.2	8.3	630	2490	3350	11.4	10.9	10.5	
		60 + 60	4.10	4.10	-	-	2.1	8.2	8.3	630	2490	3350	11.4	10.9	10.5	
	3 room	20 + 20 + 20	2.57	2.57	2.57	-	3.2	7.7	8.9	660	1870	3350	8.6	8.2	7.9	
		20 + 20 + 25	2.46	2.46	3.08	-	3.2	8.0	8.9	660	1970	3350	9.0	8.7	8.3	
		20 + 20 + 35	2.24	2.24	3.92	-	3.2	8.4	8.9	660	2100	3350	9.6	9.2	8.8	
		20 + 20 + 50	1.87	1.87	4.67	-	3.2	8.4	8.9	660	2100	3350	9.6	9.2	8.8	
		20 + 20 + 60	1.68	1.68	5.04	-	3.2	8.4	8.9	660	2100	3350	9.6	9.2	8.8	
		20 + 25 + 25	2.34	2.93	2.93	-	3.2	8.2	8.9	660	2030	3350	9.3	8.9	8.5	
		20 + 25 + 35	2.10	2.63	3.68	-	3.2	8.4	8.9	660	2100	3350	9.6	9.2	8.8	
		20 + 25 + 50	1.77	2.21	4.42	-	3.2	8.4	8.9	660	2100	3350	9.6	9.2	8.8	
		20 + 25 + 60	1.60	2.00	4.80	-	3.2	8.4	8.9	660	2100	3350	9.6	9.2	8.8	
		20 + 35 + 35	1.87	3.27	3.27	-	3.2	8.4	8.9	660	2100	3350	9.6	9.2	8.8	
		20 + 35 + 50	1.60	2.80	4.00	-	3.2	8.4	8.9	660	2100	3350	9.6	9.2	8.8	
		20 + 35 + 60	1.46	2.56	4.38	-	3.2	8.4	8.9	660	2100	3350	9.6	9.2	8.8	
		20 + 50 + 50	1.40	3.50	3.50	-	3.2	8.4	8.9	660	2100	3350	9.6	9.2	8.8	
		25 + 25 + 25	2.80	2.80	2.80	-	3.2	8.4	8.9	660	2100	3350	9.6	9.2	8.8	
		25 + 25 + 35	2.47	2.47	3.46	-	3.2	8.4	8.9	660	2100	3350	9.6	9.2	8.8	
		25 + 25 + 50	2.10	2.10	4.20	-	3.2	8.4	8.9	660	2100	3350	9.6	9.2	8.8	
		25 + 25 + 60	1.91	1.91	4.58	-	3.2	8.4	8.9	660	2100	3350	9.6	9.2	8.8	
		25 + 35 + 35	2.21	3.09	3.09	-	3.2	8.4	8.9	660	2100	3350	9.6	9.2	8.8	
		25 + 35 + 50	1.91	2.67	3.82	-	3.2	8.4	8.9	660	2100	3350	9.6	9.2	8.8	
		25 + 35 + 60	1.75	2.45	4.20	-	3.2	8.4	8.9	660	2100	3350	9.6	9.2	8.8	
		25 + 50 + 50	1.68	3.36	3.36	-	3.2	8.4	8.9	660	2100	3350	9.6	9.2	8.8	
		35 + 35 + 35	2.80	2.80	2.80	-	3.2	8.4	8.9	660	2100	3350	9.6	9.2	8.8	
		35 + 35 + 50	2.45	2.45	3.50	-	3.2	8.4	8.9	660	2100	3350	9.6	9.2	8.8	
		4 room	20 + 20 + 20 + 20	2.10	2.10	2.10	2.10	3.6	8.4	9.1	800	2010	3350	9.2	8.8	8.5
			20 + 20 + 20 + 25	1.98	1.98	1.98	2.47	3.6	8.4	9.1	800	2010	3350	9.2	8.8	8.5
			20 + 20 + 20 + 35	1.79	1.79	1.79	3.13	3.6	8.5	9.1	800	2030	3350	9.3	8.9	8.5
			20 + 20 + 20 + 50	1.56	1.56	1.56	3.91	3.6	8.6	9.1	800	2050	3350	9.4	9.0	8.6
			20 + 20 + 20 + 60	1.43	1.43	1.43	4.30	3.6	8.6	9.1	800	2050	3350	9.4	9.0	8.6
			20 + 20 + 25 + 25	1.89	1.89	2.36	2.36	3.6	8.5	9.1	800	2030	3350	9.3	8.9	8.5
			20 + 20 + 25 + 35	1.70	1.70	2.13	2.98	3.6	8.5	9.1	800	2030	3350	9.3	8.9	8.5
			20 + 20 + 25 + 50	1.50	1.50	1.87	3.74	3.6	8.6	9.1	800	2050	3350	9.4	9.0	8.6
			20 + 20 + 25 + 60	1.38	1.38	1.72	4.13	3.6	8.6	9.1	800	2050	3350	9.4	9.0	8.6
			20 + 20 + 35 + 35	1.56	1.56	2.74	2.74	3.6	8.6	9.1	800	2050	3350	9.4	9.0	8.6
			20 + 20 + 35 + 50	1.38	1.38	2.41	3.44	3.6	8.6	9.1	800	2050	3350	9.4	9.0	8.6
			20 + 25 + 25 + 25	1.79	2.24	2.24	2.24	3.6	8.5	9.1	800	2030	3350	9.3	8.9	8.5
	20 + 25 + 25 + 35		1.64	2.05	2.05	2.87	3.6	8.6	9.1	800	2050	3350	9.4	9.0	8.6	
	20 + 25 + 25 + 50		1.43	1.79	1.79	3.58	3.6	8.6	9.1	800	2050	3350	9.4	9.0	8.6	
	20 + 25 + 35 + 35		1.50	1.87	2.62	2.62	3.6	8.6	9.1	800	2050	3350	9.4	9.0	8.6	
	20 + 35 + 35 + 35		1.38	2.41	2.41	2.41	3.6	8.6	9.1	800	2050	3350	9.4	9.0	8.6	
25 + 25 + 25 + 25	2.13		2.13	2.13	2.13	3.6	8.5	9.1	800	2030	3350	9.3	8.9	8.5		
25 + 25 + 25 + 35	1.95		1.95	1.95	2.74	3.6	8.6	9.1	800	2050	3350	9.4	9.0	8.6		
25 + 25 + 25 + 50	1.72		1.72	1.72	3.44	3.6	8.6	9.1	800	2050	3350	9.4	9.0	8.6		
25 + 25 + 35 + 35	1.79		1.79	2.51	2.51	3.6	8.6	9.1	800	2050	3350	9.4	9.0	8.6		

Indoor unit combination		Cooling capacity (kW)							Power consumption(W)			Standard current(A)			
		Room cooling capacity				Total capacity			Min.	Standard	Max.	220V	230V	240V	
		A	B	C	D	Min.	Standard	Max.							
Cooling operation	1 room	20	2.0	-	-	-	1.8	2.0	2.7	480	530	950	2.4	2.3	2.2
		25	2.5	-	-	-	1.8	2.5	3.2	480	730	1080	3.4	3.2	3.1
		35	3.5	-	-	-	1.8	3.5	3.7	480	1120	1240	5.1	4.9	4.7
		50	5.0	-	-	-	1.8	5.0	5.8	480	1710	2100	7.9	7.5	7.2
		60	6.0	-	-	-	1.8	6.0	6.7	480	2140	2700	9.8	9.4	9.0
	2 room	20 + 20	2.00	2.00	-	-	3.0	4.0	5.8	550	930	1910	4.3	4.1	3.9
		20 + 25	2.00	2.50	-	-	3.0	4.5	6.1	550	1170	2060	5.4	5.1	4.9
		20 + 35	2.00	3.50	-	-	3.0	5.5	6.6	550	1590	2320	7.3	7.0	6.7
		20 + 50	1.94	4.86	-	-	3.0	6.8	7.3	550	2150	2750	9.9	9.4	9.0
		20 + 60	1.70	5.10	-	-	3.0	6.8	7.3	550	2150	2750	9.9	9.4	9.0
		25 + 25	2.50	2.50	-	-	3.0	5.0	6.5	550	1360	2270	6.2	6.0	5.7
		25 + 35	2.46	3.44	-	-	3.0	5.9	6.8	550	1780	2470	8.2	7.8	7.5
		25 + 50	2.27	4.53	-	-	3.0	6.8	7.3	550	2150	2750	9.9	9.4	9.0
		25 + 60	2.00	4.80	-	-	3.0	6.8	7.3	550	2150	2750	9.9	9.4	9.0
		35 + 35	3.40	3.40	-	-	3.0	6.8	7.2	550	2150	2680	9.9	9.4	9.0
		35 + 50	2.80	4.00	-	-	3.0	6.8	7.3	550	2150	2750	9.9	9.4	9.0
		35 + 60	2.51	4.29	-	-	3.0	6.8	7.3	550	2150	2750	9.9	9.4	9.0
		50 + 50	3.40	3.40	-	-	3.0	6.8	7.3	550	2150	2750	9.9	9.4	9.0
		50 + 60	3.09	3.71	-	-	3.0	6.8	7.3	550	2150	2750	9.9	9.4	9.0
		60 + 60	3.40	3.40	-	-	3.0	6.8	7.3	550	2150	2750	9.9	9.4	9.0
	3 room	20 + 20 + 20	2.00	2.00	2.00	-	3.7	6.0	7.8	670	1450	2750	6.7	6.4	6.1
		20 + 20 + 25	2.00	2.00	2.50	-	3.7	6.5	7.8	670	1630	2750	7.5	7.2	6.9
		20 + 20 + 35	1.84	1.84	3.22	-	3.7	6.9	7.8	670	1910	2750	8.8	8.4	8.0
		20 + 20 + 50	1.53	1.53	3.83	-	3.7	6.9	7.8	670	1910	2750	8.8	8.4	8.0
		20 + 20 + 60	1.38	1.38	4.14	-	3.7	6.9	7.8	670	1910	2750	8.8	8.4	8.0
		20 + 25 + 25	1.94	2.43	2.43	-	3.7	6.8	7.8	670	1820	2750	8.4	8.0	7.7
		20 + 25 + 35	1.73	2.16	3.02	-	3.7	6.9	7.8	670	1910	2750	8.8	8.4	8.0



MULTI-SPLIT SYSTEM

Indoor unit combination		Cooling capacity (kW)							Power consumption(W)			Standard current(A)			
		Room cooling capacity				Total capacity			Min.	Standard	Max.	220V	230V	240V	
		A	B	C	D	Min.	Standard	Max.							
Cooling operation	3 room	20 + 25 + 50	1.45	1.82	3.63	-	3.7	6.9	7.8	670	1910	2750	8.8	8.4	8.0
		20 + 25 + 60	1.31	1.64	3.94	-	3.7	6.9	7.8	670	1910	2750	8.8	8.4	8.0
		20 + 35 + 35	1.53	2.68	2.68	-	3.7	6.9	7.8	670	1910	2750	8.8	8.4	8.0
		20 + 35 + 50	1.31	2.30	3.29	-	3.7	6.9	7.8	670	1910	2750	8.8	8.4	8.0
		20 + 35 + 60	1.20	2.10	3.60	-	3.7	6.9	7.8	670	1910	2750	8.8	8.4	8.0
		20 + 50 + 50	1.15	2.88	2.88	-	3.7	6.9	7.8	670	1910	2750	8.8	8.4	8.0
		25 + 25 + 25	2.30	2.30	2.30	-	3.7	6.9	7.8	670	1910	2750	8.8	8.4	8.0
		25 + 25 + 35	2.03	2.03	2.84	-	3.7	6.9	7.8	670	1910	2750	8.8	8.4	8.0
		25 + 25 + 50	1.73	1.73	3.45	-	3.7	6.9	7.8	670	1910	2750	8.8	8.4	8.0
		25 + 25 + 60	1.57	1.57	3.76	-	3.7	6.9	7.8	670	1910	2750	8.8	8.4	8.0
		25 + 35 + 35	1.82	2.54	2.54	-	3.7	6.9	7.8	670	1910	2750	8.8	8.4	8.0
		25 + 35 + 50	1.57	2.20	3.14	-	3.7	6.9	7.8	670	1910	2750	8.8	8.4	8.0
	25 + 35 + 60	1.44	2.01	3.45	-	3.7	6.9	7.8	670	1910	2750	8.8	8.4	8.0	
	25 + 50 + 50	1.38	2.76	2.76	-	3.7	6.9	7.8	670	1910	2750	8.8	8.4	8.0	
	35 + 35 + 35	2.30	2.30	2.30	-	3.7	6.9	7.8	670	1910	2750	8.8	8.4	8.0	
	35 + 35 + 50	2.01	2.01	2.88	-	3.7	6.9	7.8	670	1910	2750	8.8	8.4	8.0	
	4 room	20 + 20 + 20 + 20	1.73	1.73	1.73	1.73	4.4	6.9	8.3	890	1750	2750	8.0	7.7	7.4
		20 + 20 + 20 + 25	1.62	1.62	1.62	2.03	4.4	6.9	8.3	890	1750	2750	8.0	7.7	7.4
		20 + 20 + 20 + 35	1.49	1.49	1.49	2.62	4.4	7.1	8.3	890	1790	2750	8.2	7.9	7.5
		20 + 20 + 20 + 50	1.29	1.29	1.29	3.23	4.4	7.1	8.3	890	1790	2750	8.2	7.9	7.5
		20 + 20 + 20 + 60	1.18	1.18	1.18	3.55	4.4	7.1	8.3	890	1790	2750	8.2	7.9	7.5
		20 + 20 + 25 + 25	1.53	1.53	1.92	1.92	4.4	6.9	8.3	890	1750	2750	8.0	7.7	7.4
		20 + 20 + 25 + 35	1.42	1.42	1.78	2.49	4.4	7.1	8.3	890	1790	2750	8.2	7.9	7.5
		20 + 20 + 25 + 50	1.23	1.23	1.54	3.09	4.4	7.1	8.3	890	1790	2750	8.2	7.9	7.5
		20 + 20 + 25 + 60	1.14	1.14	1.42	3.41	4.4	7.1	8.3	890	1790	2750	8.2	7.9	7.5
		20 + 20 + 35 + 35	1.29	1.29	2.26	2.26	4.4	7.1	8.3	890	1790	2750	8.2	7.9	7.5
		20 + 20 + 35 + 50	1.14	1.14	1.99	2.84	4.4	7.1	8.3	890	1790	2750	8.2	7.9	7.5
		20 + 25 + 25 + 25	1.49	1.87	1.87	1.87	4.4	7.1	8.3	890	1790	2750	8.2	7.9	7.5
		20 + 25 + 25 + 35	1.35	1.69	1.69	2.37	4.4	7.1	8.3	890	1790	2750	8.2	7.9	7.5
		20 + 25 + 25 + 50	1.18	1.48	1.48	2.96	4.4	7.1	8.3	890	1790	2750	8.2	7.9	7.5
		20 + 25 + 35 + 35	1.23	1.54	2.16	2.16	4.4	7.1	8.3	890	1790	2750	8.2	7.9	7.5
		20 + 35 + 35 + 35	1.14	1.99	1.99	1.99	4.4	7.1	8.3	890	1790	2750	8.2	7.9	7.5
		25 + 25 + 25 + 25	1.78	1.78	1.78	1.78	4.4	7.1	8.3	890	1790	2750	8.2	7.9	7.5
25 + 25 + 25 + 35		1.61	1.61	1.61	2.26	4.4	7.1	8.3	890	1790	2750	8.2	7.9	7.5	
25 + 25 + 25 + 50	1.42	1.42	1.42	2.84	4.4	7.1	8.3	890	1790	2750	8.2	7.9	7.5		
25 + 25 + 35 + 35	1.48	1.48	2.07	2.07	4.4	7.1	8.3	890	1790	2750	8.2	7.9	7.5		

SCM80ZM-S1 Table of Indoor unit combination only with SRK-ZSX type

Indoor unit combination		Heating capacity (kW)							Power consumption(W)			Standard current(A)			
		Room heating capacity				Total capacity			Min.	Standard	Max.	220V	230V	240V	
		A	B	C	D	Min.	Standard	Max.							
Heating operation	1 room	20	3.0	-	-	-	1.5	3.0	3.7	600	840	1330	3.9	3.7	3.5
		25	3.4	-	-	-	1.5	3.4	4.2	600	1000	1510	4.6	4.4	4.2
		35	4.5	-	-	-	1.5	4.5	5.0	600	1330	1790	6.1	5.8	5.6
		50	5.8	-	-	-	1.5	5.8	6.5	600	1780	2310	8.2	7.8	7.5
	2 room	60	6.8	-	-	-	1.5	6.8	7.5	600	2100	2660	9.6	9.2	8.8
		20 + 20	2.70	2.70	-	-	2.1	5.4	7.4	630	1340	1870	6.2	5.9	5.6
		20 + 25	2.62	3.28	-	-	2.1	5.9	7.7	630	1530	2130	7.0	6.7	6.4
		20 + 35	2.51	4.39	-	-	2.1	6.9	8.3	630	1910	2650	8.8	8.4	8.0
		20 + 50	2.37	5.93	-	-	2.1	8.3	8.8	630	2460	3430	11.3	10.8	10.4
		20 + 60	2.08	6.23	-	-	2.1	8.3	8.8	630	2460	3430	11.3	10.8	10.4
		25 + 25	3.20	3.20	-	-	2.1	6.4	8.1	630	1700	2480	7.8	7.5	7.2
		25 + 35	3.08	4.32	-	-	2.1	7.4	8.6	630	2090	2910	9.6	9.2	8.8
		25 + 50	2.77	5.53	-	-	2.1	8.3	8.8	630	2460	3430	11.3	10.8	10.4
		25 + 60	2.44	5.86	-	-	2.1	8.3	8.8	630	2460	3430	11.3	10.8	10.4
		35 + 35	4.15	4.15	-	-	2.1	8.3	8.8	630	2460	3430	11.3	10.8	10.4
		35 + 50	3.42	4.88	-	-	2.1	8.3	8.8	630	2460	3430	11.3	10.8	10.4
		35 + 60	3.06	5.24	-	-	2.1	8.3	8.8	630	2460	3430	11.3	10.8	10.4
		50 + 50	4.15	4.15	-	-	2.1	8.3	8.8	630	2460	3430	11.3	10.8	10.4
		50 + 60	3.77	4.53	-	-	2.1	8.3	8.8	630	2460	3430	11.3	10.8	10.4
	60 + 60	4.15	4.15	-	-	2.1	8.3	8.8	630	2460	3430	11.3	10.8	10.4	
	3 room	20 + 20 + 20	2.57	2.57	2.57	-	3.2	7.7	9.3	660	1830	3430	8.4	8.0	7.7
		20 + 20 + 25	2.46	2.46	3.08	-	3.2	8.0	9.3	660	1930	3430	8.9	8.5	8.1
		20 + 20 + 35	2.27	2.27	3.97	-	3.2	8.5	9.3	660	2090	3430	9.6	9.2	8.8
		20 + 20 + 50	2.00	2.00	5.00	-	3.2	9.0	9.3	660	2250	3430	10.3	9.9	9.5
		20 + 20 + 60	1.80	1.80	5.40	-	3.2	9.0	9.3	660	2250	3430	10.3	9.9	9.5
		20 + 25 + 25	2.34	2.93	2.93	-	3.2	8.2	9.3	660	1990	3430	9.1	8.7	8.4
		20 + 25 + 35	2.20	2.75	3.85	-	3.2	8.8	9.3	660	2180	3430	10.0	9.6	9.2
		20 + 25 + 50	1.89	2.37	4.74	-	3.2	9.0	9.3	660	2250	3430	10.3	9.9	9.5
		20 + 25 + 60	1.71	2.14	5.14	-	3.2	9.0	9.3	660	2250	3430	10.3	9.9	9.5
		20 + 35 + 35	2.00	3.50	3.50	-	3.2	9.0	9.3	660	2250	3430	10.3	9.9	9.5
		20 + 35 + 50	1.71	3.00	4.29	-	3.2	9.0	9.3	660	2250	3430	10.3	9.9	9.5
		20 + 35 + 60	1.57	2.74	4.70	-	3.2	9.0	9.3	660	2250	3430	10.3	9.9	9.5
		20 + 50 + 50	1.50	3.75	3.75	-	3.2	9.0	9.3	660	2250	3430	10.3	9.9	9.5
20 + 50 + 60		1.38	3.46	4.15	-	3.2	9.0	9.3	660	2250	3430	10.3	9.9	9.5	

COMBINATIONS

Indoor unit combination		Heating capacity (kW)							Power consumption(W)			Standard current(A)			
		Room heating capacity				Total capacity			Min.	Standard	Max.	220V	230V	240V	
		A	B	C	D	Min.	Standard	Max.							
Heating operation	3 room	25 + 25 + 25	2.83	2.83	2.83	-	3.2	8.5	9.3	660	2090	3430	9.6	9.2	8.8
		25 + 25 + 35	2.65	2.65	3.71	-	3.2	9.0	9.3	660	2250	3430	10.3	9.9	9.5
		25 + 25 + 50	2.25	2.25	4.50	-	3.2	9.0	9.3	660	2250	3430	10.3	9.9	9.5
		25 + 25 + 60	2.05	2.05	4.91	-	3.2	9.0	9.3	660	2250	3430	10.3	9.9	9.5
		25 + 35 + 35	2.37	3.32	3.32	-	3.2	9.0	9.3	660	2250	3430	10.3	9.9	9.5
		25 + 35 + 50	2.05	2.86	4.09	-	3.2	9.0	9.3	660	2250	3430	10.3	9.9	9.5
		25 + 35 + 60	1.88	2.63	4.50	-	3.2	9.0	9.3	660	2250	3430	10.3	9.9	9.5
		25 + 50 + 50	1.80	3.60	3.60	-	3.2	9.0	9.3	660	2250	3430	10.3	9.9	9.5
		25 + 50 + 60	1.67	3.33	4.00	-	3.2	9.0	9.3	660	2250	3430	10.3	9.9	9.5
		35 + 35 + 35	3.00	3.00	3.00	-	3.2	9.0	9.3	660	2250	3430	10.3	9.9	9.5
	35 + 35 + 50	2.63	2.63	3.75	-	3.2	9.0	9.3	660	2250	3430	10.3	9.9	9.5	
	35 + 35 + 60	2.42	2.42	4.15	-	3.2	9.0	9.3	660	2250	3430	10.3	9.9	9.5	
	35 + 50 + 50	2.33	3.33	3.33	-	3.2	9.0	9.3	660	2250	3430	10.3	9.9	9.5	
	4 room	20 + 20 + 20 + 20	2.28	2.28	2.28	2.28	3.6	9.1	9.8	800	2220	3430	10.2	9.7	9.3
		20 + 20 + 20 + 25	2.14	2.14	2.14	2.68	3.6	9.1	9.8	800	2220	3430	10.2	9.7	9.3
		20 + 20 + 20 + 35	1.94	1.94	1.94	3.39	3.6	9.2	9.8	800	2240	3430	10.3	9.8	9.4
		20 + 20 + 20 + 50	1.67	1.67	1.67	4.18	3.6	9.2	9.8	800	2240	3430	10.3	9.8	9.4
		20 + 20 + 20 + 60	1.55	1.55	1.55	4.65	3.6	9.3	9.8	800	2260	3430	10.4	10.0	9.5
		20 + 20 + 25 + 25	2.04	2.04	2.56	2.56	3.6	9.2	9.8	800	2240	3430	10.3	9.8	9.4
		20 + 20 + 25 + 35	1.84	1.84	2.30	3.22	3.6	9.2	9.8	800	2240	3430	10.3	9.8	9.4
		20 + 20 + 25 + 50	1.62	1.62	2.02	4.04	3.6	9.3	9.8	800	2260	3430	10.4	10.0	9.5
		20 + 20 + 25 + 60	1.49	1.49	1.86	4.46	3.6	9.3	9.8	800	2260	3430	10.4	10.0	9.5
		20 + 20 + 35 + 35	1.67	1.67	2.93	2.93	3.6	9.2	9.8	800	2240	3430	10.3	9.8	9.4
		20 + 20 + 35 + 50	1.49	1.49	2.60	3.72	3.6	9.3	9.8	800	2260	3430	10.4	10.0	9.5
		20 + 20 + 35 + 60	1.38	1.38	2.41	4.13	3.6	9.3	9.8	800	2260	3430	10.4	10.0	9.5
		20 + 25 + 25 + 25	1.94	2.42	2.42	2.42	3.6	9.2	9.8	800	2240	3430	10.3	9.8	9.4
		20 + 25 + 25 + 35	1.75	2.19	2.19	3.07	3.6	9.2	9.8	800	2240	3430	10.3	9.8	9.4
		20 + 25 + 25 + 50	1.55	1.94	1.94	3.88	3.6	9.3	9.8	800	2260	3430	10.4	10.0	9.5
		20 + 25 + 25 + 60	1.43	1.79	1.79	4.29	3.6	9.3	9.8	800	2260	3430	10.4	10.0	9.5
		20 + 25 + 35 + 35	1.62	2.02	2.83	2.83	3.6	9.3	9.8	800	2260	3430	10.4	10.0	9.5
20 + 25 + 35 + 50		1.43	1.79	2.50	3.58	3.6	9.3	9.8	800	2260	3430	10.4	10.0	9.5	
20 + 35 + 35 + 35		1.49	2.60	2.60	2.60	3.6	9.3	9.8	800	2260	3430	10.4	10.0	9.5	
25 + 25 + 25 + 25		2.30	2.30	2.30	2.30	3.6	9.2	9.8	800	2240	3430	10.3	9.8	9.4	
25 + 25 + 25 + 35	2.09	2.09	2.09	2.93	3.6	9.2	9.8	800	2240	3430	10.3	9.8	9.4		
25 + 25 + 25 + 50	1.86	1.86	1.86	3.72	3.6	9.3	9.8	800	2260	3430	10.4	10.0	9.5		
25 + 25 + 25 + 60	1.72	1.72	1.72	4.13	3.6	9.3	9.8	800	2260	3430	10.4	10.0	9.5		
25 + 25 + 35 + 35	1.94	1.94	2.71	2.71	3.6	9.3	9.8	800	2260	3430	10.4	10.0	9.5		
25 + 25 + 35 + 50	1.72	1.72	2.41	3.44	3.6	9.3	9.8	800	2260	3430	10.4	10.0	9.5		
25 + 35 + 35 + 35	1.79	2.50	2.50	2.50	3.6	9.3	9.8	800	2260	3430	10.4	10.0	9.5		

Indoor unit combination		Cooling capacity (kW)							Power consumption(W)			Standard current(A)			
		Room cooling capacity				Total capacity			Min.	Standard	Max.	220V	230V	240V	
		A	B	C	D	Min.	Standard	Max.							
Cooling operation	1 room	20	2.0	-	-	-	1.8	2.0	2.8	480	500	950	2.3	2.2	2.1
		25	2.5	-	-	-	1.8	2.5	3.4	480	680	1080	3.1	3.0	2.9
		35	3.5	-	-	-	1.8	3.5	3.9	480	1010	1240	4.6	4.4	4.3
		50	5.0	-	-	-	1.8	5.0	6.1	480	1530	2100	7.0	6.7	6.4
		60	6.0	-	-	-	1.8	6.0	7.0	480	1880	2700	8.6	8.3	7.9
	2 room	20 + 20	2.00	2.00	-	-	3.0	4.0	6.1	550	830	1910	3.8	3.6	3.5
		20 + 25	2.00	2.50	-	-	3.0	4.5	6.4	550	1030	2060	4.7	4.5	4.3
		20 + 35	2.00	3.50	-	-	3.0	5.5	6.9	550	1390	2320	6.4	6.1	5.9
		20 + 50	1.97	4.93	-	-	3.0	6.9	7.9	550	1910	2830	8.8	8.4	8.0
		20 + 60	1.85	5.55	-	-	3.0	7.4	7.9	550	2090	2830	9.6	9.2	8.8
		25 + 25	2.50	2.50	-	-	3.0	5.0	6.8	550	1190	2270	5.5	5.2	5.0
		25 + 35	2.46	3.44	-	-	3.0	5.9	7.2	550	1560	2470	7.2	6.9	6.6
		25 + 50	2.47	4.93	-	-	3.0	7.4	7.9	550	2090	2830	9.6	9.2	8.8
		25 + 60	2.18	5.22	-	-	3.0	7.4	7.9	550	2090	2830	9.6	9.2	8.8
		35 + 35	3.45	3.45	-	-	3.0	6.9	7.6	550	1910	2680	8.8	8.4	8.0
		35 + 50	3.05	4.35	-	-	3.0	7.4	7.9	550	2090	2830	9.6	9.2	8.8
		35 + 60	2.73	4.67	-	-	3.0	7.4	7.9	550	2090	2830	9.6	9.2	8.8
		50 + 50	3.70	3.70	-	-	3.0	7.4	7.9	550	2090	2830	9.6	9.2	8.8
		50 + 60	3.36	4.04	-	-	3.0	7.4	7.9	550	2090	2830	9.6	9.2	8.8
		60 + 60	3.70	3.70	-	-	3.0	7.4	7.9	550	2090	2830	9.6	9.2	8.8
	3 room	20 + 20 + 20	2.00	2.00	2.00	-	3.7	6.0	8.5	670	1300	2830	6.0	5.7	5.5
		20 + 20 + 25	2.00	2.00	2.50	-	3.7	6.5	8.5	670	1450	2830	6.7	6.4	6.1
		20 + 20 + 35	1.89	1.89	3.31	-	3.7	7.1	8.5	670	1730	2830	7.9	7.6	7.3
		20 + 20 + 50	1.73	1.73	4.33	-	3.7	7.8	8.5	670	2030	2830	9.3	8.9	8.5
		20 + 20 + 60	1.56	1.56	4.68	-	3.7	7.8	8.5	670	2030	2830	9.3	8.9	8.5
		20 + 25 + 25	1.94	2.43	2.43	-	3.7	6.8	8.5	670	1610	2830	7.4	7.1	6.8
		20 + 25 + 35	1.88	2.34	3.28	-	3.7	7.5	8.5	670	1870	2830	8.6	8.2	7.9
		20 + 25 + 50	1.64	2.05	4.11	-	3.7	7.8	8.5	670	2030	2830	9.3	8.9	8.5
		20 + 25 + 60	1.49	1.86	4.46	-	3.7	7.8	8.5	670	2030	2830	9.3	8.9	8.5
		20 + 35 + 35	1.73	3.03	3.03	-	3.7	7.8	8.5	670	2030	2830	9.3	8.9	8.5
20 + 35 + 50		1.49	2.60	3.71	-	3.7	7.8	8.5	670	2030	2830	9.3	8.9	8.5	
20 + 35 + 60		1.36	2.37	4.07	-	3.7	7.8	8.5	670	2030	2830	9.3	8.9	8.5	
20 + 50 + 50		1.30	3.25	3.25	-	3.7	7.8	8.5	670	2030	2830	9.3	8.9	8.5	
20 + 50 + 60		1.20	3.00	3.60	-	3.7	7.8	8.5	670	2030	2830	9.3	8.9	8.5	



MULTI-SPLIT SYSTEM

Indoor unit combination		Cooling capacity (kW)							Power consumption(W)			Standard current(A)			
		Room cooling capacity				Total capacity			Min.	Standard	Max.	220V	230V	240V	
		A	B	C	D	Min.	Standard	Max.							
Cooling operation	3 room	25 + 25 + 25	2.37	2.37	2.37	-	3.7	7.1	8.5	670	1730	2830	7.9	7.6	7.3
		25 + 25 + 35	2.29	2.29	3.21	-	3.7	7.8	8.5	670	2030	2830	9.3	8.9	8.5
		25 + 25 + 50	1.95	1.95	3.90	-	3.7	7.8	8.5	670	2030	2830	9.3	8.9	8.5
		25 + 25 + 60	1.77	1.77	4.25	-	3.7	7.8	8.5	670	2030	2830	9.3	8.9	8.5
		25 + 35 + 35	2.05	2.87	2.87	-	3.7	7.8	8.5	670	2030	2830	9.3	8.9	8.5
		25 + 35 + 50	1.77	2.48	3.55	-	3.7	7.8	8.5	670	2030	2830	9.3	8.9	8.5
		25 + 35 + 60	1.63	2.28	3.90	-	3.7	7.8	8.5	670	2030	2830	9.3	8.9	8.5
		25 + 50 + 50	1.56	3.12	3.12	-	3.7	7.8	8.5	670	2030	2830	9.3	8.9	8.5
		25 + 50 + 60	1.44	2.89	3.47	-	3.7	7.8	8.5	670	2030	2830	9.3	8.9	8.5
		35 + 35 + 35	2.60	2.60	2.60	-	3.7	7.8	8.5	670	2030	2830	9.3	8.9	8.5
		35 + 35 + 50	2.28	2.28	3.25	-	3.7	7.8	8.5	670	2030	2830	9.3	8.9	8.5
		35 + 35 + 60	2.10	2.10	3.60	-	3.7	7.8	8.5	670	2030	2830	9.3	8.9	8.5
	35 + 50 + 50	2.02	2.89	2.89	-	3.7	7.8	8.5	670	2030	2830	9.3	8.9	8.5	
	4 room	20 + 20 + 20 + 20	1.95	1.95	1.95	1.95	4.4	7.8	9.2	890	1920	2830	8.8	8.4	8.1
		20 + 20 + 20 + 25	1.84	1.84	1.84	2.29	4.4	7.8	9.2	890	1920	2830	8.8	8.4	8.1
		20 + 20 + 20 + 35	1.66	1.66	1.66	2.91	4.4	7.9	9.2	890	1940	2830	8.9	8.5	8.2
		20 + 20 + 20 + 50	1.44	1.44	1.44	3.59	4.4	7.9	9.2	890	1940	2830	8.9	8.5	8.2
		20 + 20 + 20 + 60	1.33	1.33	1.33	4.00	4.4	8.0	9.2	890	1950	2830	9.9	8.6	9.0
		20 + 20 + 25 + 25	1.76	1.76	2.19	2.19	4.4	7.9	9.2	890	1940	2830	8.9	8.5	8.2
		20 + 20 + 25 + 35	1.58	1.58	1.98	2.77	4.4	7.9	9.2	890	1940	2830	8.9	8.5	8.2
		20 + 20 + 25 + 50	1.37	1.37	1.72	3.43	4.4	7.9	9.2	890	1940	2830	8.9	8.5	8.2
		20 + 20 + 25 + 60	1.28	1.28	1.60	3.84	4.4	8.0	9.2	890	1950	2830	9.9	8.6	9.0
		20 + 20 + 35 + 35	1.44	1.44	2.51	2.51	4.4	7.9	9.2	890	1940	2830	8.9	8.5	8.2
		20 + 20 + 35 + 50	1.28	1.28	2.24	3.20	4.4	8.0	9.2	890	1950	2830	9.9	8.6	9.0
		20 + 20 + 35 + 60	1.19	1.19	2.07	3.56	4.4	8.0	9.2	890	1950	2830	9.9	8.6	9.0
		20 + 25 + 25 + 25	1.66	2.08	2.08	2.08	4.4	7.9	9.2	890	1940	2830	8.9	8.5	8.2
		20 + 25 + 25 + 35	1.50	1.88	1.88	2.63	4.4	7.9	9.2	890	1940	2830	8.9	8.5	8.2
		20 + 25 + 25 + 50	1.33	1.67	1.67	3.33	4.4	8.0	9.2	890	1950	2830	9.9	8.6	9.0
		20 + 25 + 25 + 60	1.23	1.54	1.54	3.69	4.4	8.0	9.2	890	1950	2830	9.9	8.6	9.0
		20 + 25 + 35 + 35	1.37	1.72	2.40	2.40	4.4	7.9	9.2	890	1940	2830	8.9	8.5	8.2
		20 + 25 + 35 + 50	1.23	1.54	2.15	3.08	4.4	8.0	9.2	890	1950	2830	9.9	8.6	9.0
		20 + 35 + 35 + 35	1.28	2.24	2.24	2.24	4.4	8.0	9.2	890	1950	2830	9.9	8.6	9.0
		25 + 25 + 25 + 25	1.98	1.98	1.98	1.98	4.4	7.9	9.2	890	1940	2830	8.9	8.5	8.2
		25 + 25 + 25 + 35	1.80	1.80	1.80	2.51	4.4	7.9	9.2	890	1940	2830	8.9	8.5	8.2
		25 + 25 + 25 + 50	1.60	1.60	1.60	3.20	4.4	8.0	9.2	890	1950	2830	9.9	8.6	9.0
25 + 25 + 25 + 60		1.48	1.48	1.48	3.56	4.4	8.0	9.2	890	1950	2830	9.9	8.6	9.0	
25 + 25 + 35 + 35	1.67	1.67	2.33	2.33	4.4	8.0	9.2	890	1950	2830	9.9	8.6	9.0		
25 + 25 + 35 + 50	1.48	1.48	2.07	2.96	4.4	8.0	9.2	890	1950	2830	9.9	8.6	9.0		
25 + 35 + 35 + 35	1.54	2.15	2.15	2.15	4.4	8.0	9.2	890	1950	2830	9.9	8.6	9.0		

SCM80ZM-S1 Table of Indoor unit combination with other indoor unit

Indoor unit combination		Heating capacity (kW)							Power consumption(W)			Standard current(A)			
		Room heating capacity				Total capacity			Min.	Standard	Max.	220V	230V	240V	
		A	B	C	D	Min.	Standard	Max.							
Heating operation	1 room	20	3.0	-	-	-	1.5	3.0	3.5	600	1060	1330	4.9	4.7	4.5
		25	3.4	-	-	-	1.5	3.4	4.0	600	1220	1510	5.6	5.4	5.1
		35	4.5	-	-	-	1.5	4.5	4.8	600	1510	1790	6.9	6.6	6.4
		50	5.8	-	-	-	1.5	5.8	6.2	600	1950	2310	9.0	8.6	8.2
		60	6.8	-	-	-	1.5	6.8	7.1	600	2240	2660	10.3	9.8	9.4
	2 room	20 + 20	2.70	2.70	-	-	2.1	5.4	7.0	630	1370	1870	6.3	6.0	5.8
		20 + 25	2.62	3.28	-	-	2.1	5.9	7.3	630	1560	2130	7.2	6.9	6.6
		20 + 35	2.51	4.39	-	-	2.1	6.9	7.9	630	1950	2650	9.0	8.6	8.2
		20 + 50	2.37	5.93	-	-	2.1	8.3	8.4	630	2510	3430	11.5	11.0	10.6
		20 + 60	2.08	6.23	-	-	2.1	8.3	8.4	630	2510	3430	11.5	11.0	10.6
		25 + 25	3.20	3.20	-	-	2.1	6.4	7.7	630	1740	2480	8.0	7.6	7.3
		25 + 35	3.08	4.32	-	-	2.1	7.4	8.2	630	2130	2910	9.8	9.4	9.0
		25 + 50	2.77	5.53	-	-	2.1	8.3	8.4	630	2510	3430	11.5	11.0	10.6
		25 + 60	2.44	5.86	-	-	2.1	8.3	8.4	630	2510	3430	11.5	11.0	10.6
		35 + 35	4.15	4.15	-	-	2.1	8.3	8.4	630	2510	3430	11.5	11.0	10.6
		35 + 50	3.42	4.88	-	-	2.1	8.3	8.4	630	2510	3430	11.5	11.0	10.6
		35 + 60	3.06	5.24	-	-	2.1	8.3	8.4	630	2510	3430	11.5	11.0	10.6
		50 + 50	4.15	4.15	-	-	2.1	8.3	8.4	630	2510	3430	11.5	11.0	10.6
		50 + 60	3.77	4.53	-	-	2.1	8.3	8.4	630	2510	3430	11.5	11.0	10.6
		60 + 60	4.15	4.15	-	-	2.1	8.3	8.4	630	2510	3430	11.5	11.0	10.6
	3 room	20 + 20 + 20	2.57	2.57	2.57	-	3.2	7.7	9.1	660	1870	3430	8.6	8.2	7.9
		20 + 20 + 25	2.46	2.46	3.08	-	3.2	8.0	9.1	660	1970	3430	9.0	8.7	8.3
		20 + 20 + 35	2.27	2.27	3.97	-	3.2	8.5	9.1	660	2130	3430	9.8	9.4	9.0
		20 + 20 + 50	2.00	2.00	5.00	-	3.2	9.0	9.1	660	2300	3430	10.6	10.1	9.7
		20 + 20 + 60	1.80	1.80	5.40	-	3.2	9.0	9.1	660	2300	3430	10.6	10.1	9.7
		20 + 25 + 25	2.34	2.93	2.93	-	3.2	8.2	9.1	660	2030	3430	9.3	8.9	8.5
		20 + 25 + 35	2.20	2.75	3.85	-	3.2	8.8	9.1	660	2220	3430	10.2	9.7	9.3
		20 + 25 + 50	1.89	2.37	4.74	-	3.2	9.0	9.1	660	2300	3430	10.6	10.1	9.7
		20 + 25 + 60	1.71	2.14	5.14	-	3.2	9.0	9.1	660	2300	3430	10.6	10.1	9.7
		20 + 35 + 35	2.00	3.50	3.50	-	3.2	9.0	9.1	660	2300	3430	10.6	10.1	9.7

COMBINATIONS

Indoor unit combination		Heating capacity (kW)							Power consumption(W)			Standard current(A)			
		Room heating capacity				Total capacity			Min.	Standard	Max.	220V	230V	240V	
		A	B	C	D	Min.	Standard	Max.							
Heating operation	3 room	20 + 35 + 50	1.71	3.00	4.29	-	3.2	9.0	9.1	660	2300	3430	10.6	10.1	9.7
		20 + 35 + 60	1.57	2.74	4.70	-	3.2	9.0	9.1	660	2300	3430	10.6	10.1	9.7
		20 + 50 + 50	1.50	3.75	3.75	-	3.2	9.0	9.1	660	2300	3430	10.6	10.1	9.7
		20 + 50 + 60	1.38	3.46	4.15	-	3.2	9.0	9.1	660	2300	3430	10.6	10.1	9.7
		25 + 25 + 25	2.83	2.83	2.83	-	3.2	8.5	9.1	660	2130	3430	9.8	9.4	9.0
		25 + 25 + 35	2.65	2.65	3.71	-	3.2	9.0	9.1	660	2300	3430	10.6	10.1	9.7
		25 + 25 + 50	2.25	2.25	4.50	-	3.2	9.0	9.1	660	2300	3430	10.6	10.1	9.7
		25 + 25 + 60	2.05	2.05	4.91	-	3.2	9.0	9.1	660	2300	3430	10.6	10.1	9.7
		25 + 35 + 35	2.37	3.32	3.32	-	3.2	9.0	9.1	660	2300	3430	10.6	10.1	9.7
		25 + 35 + 50	2.05	2.86	4.09	-	3.2	9.0	9.1	660	2300	3430	10.6	10.1	9.7
		25 + 35 + 60	1.88	2.63	4.50	-	3.2	9.0	9.1	660	2300	3430	10.6	10.1	9.7
		25 + 50 + 50	1.80	3.60	3.60	-	3.2	9.0	9.1	660	2300	3430	10.6	10.1	9.7
		25 + 50 + 60	1.67	3.33	4.00	-	3.2	9.0	9.1	660	2300	3430	10.6	10.1	9.7
		35 + 35 + 35	3.00	3.00	3.00	-	3.2	9.0	9.1	660	2300	3430	10.6	10.1	9.7
		35 + 35 + 50	2.63	2.63	3.75	-	3.2	9.0	9.1	660	2300	3430	10.6	10.1	9.7
	35 + 35 + 60	2.42	2.42	4.15	-	3.2	9.0	9.1	660	2300	3430	10.6	10.1	9.7	
	35 + 50 + 50	2.33	3.33	3.33	-	3.2	9.0	9.1	660	2300	3430	10.6	10.1	9.7	
	4 room	20 + 20 + 20 + 20	2.28	2.28	2.28	2.28	3.6	9.1	9.5	800	2270	3430	10.4	10.0	9.6
		20 + 20 + 20 + 25	2.14	2.14	2.14	2.68	3.6	9.1	9.5	800	2270	3430	10.4	10.0	9.6
		20 + 20 + 20 + 35	1.94	1.94	1.94	3.39	3.6	9.2	9.5	800	2290	3430	10.5	10.1	9.6
		20 + 20 + 20 + 50	1.67	1.67	1.67	4.18	3.6	9.2	9.5	800	2290	3430	10.5	10.1	9.6
		20 + 20 + 20 + 60	1.55	1.55	1.55	4.65	3.6	9.3	9.5	800	2310	3430	10.7	10.2	9.8
		20 + 20 + 25 + 25	2.04	2.04	2.56	2.56	3.6	9.2	9.5	800	2290	3430	10.5	10.1	9.6
		20 + 20 + 25 + 35	1.84	1.84	2.30	3.22	3.6	9.2	9.5	800	2290	3430	10.5	10.1	9.6
		20 + 20 + 25 + 50	1.62	1.62	2.02	4.04	3.6	9.3	9.5	800	2310	3430	10.7	10.2	9.8
		20 + 20 + 25 + 60	1.49	1.49	1.86	4.46	3.6	9.3	9.5	800	2310	3430	10.7	10.2	9.8
		20 + 20 + 35 + 35	1.67	1.67	2.93	2.93	3.6	9.2	9.5	800	2290	3430	10.5	10.1	9.6
		20 + 20 + 35 + 50	1.49	1.49	2.60	3.72	3.6	9.3	9.5	800	2310	3430	10.7	10.2	9.8
		20 + 20 + 35 + 60	1.38	1.38	2.41	4.13	3.6	9.3	9.5	800	2310	3430	10.7	10.2	9.8
		20 + 25 + 25 + 25	1.94	2.42	2.42	2.42	3.6	9.2	9.5	800	2290	3430	10.5	10.1	9.6
		20 + 25 + 25 + 35	1.75	2.19	2.19	3.07	3.6	9.2	9.5	800	2290	3430	10.5	10.1	9.6
		20 + 25 + 25 + 50	1.55	1.94	1.94	3.88	3.6	9.3	9.5	800	2310	3430	10.7	10.2	9.8
		20 + 25 + 25 + 60	1.43	1.79	1.79	4.29	3.6	9.3	9.5	800	2310	3430	10.7	10.2	9.8
20 + 25 + 35 + 35		1.62	2.02	2.83	2.83	3.6	9.3	9.5	800	2310	3430	10.7	10.2	9.8	
20 + 25 + 35 + 50		1.43	1.79	2.50	3.58	3.6	9.3	9.5	800	2310	3430	10.7	10.2	9.8	
20 + 35 + 35 + 35	1.49	2.60	2.60	2.60	3.6	9.3	9.5	800	2310	3430	10.7	10.2	9.8		
25 + 25 + 25 + 25	2.30	2.30	2.30	2.30	3.6	9.2	9.5	800	2290	3430	10.5	10.1	9.6		
25 + 25 + 25 + 35	2.09	2.09	2.09	2.93	3.6	9.2	9.5	800	2290	3430	10.5	10.1	9.6		
25 + 25 + 25 + 50	1.86	1.86	1.86	3.72	3.6	9.3	9.5	800	2310	3430	10.7	10.2	9.8		
25 + 25 + 25 + 60	1.72	1.72	1.72	4.13	3.6	9.3	9.5	800	2310	3430	10.7	10.2	9.8		
25 + 25 + 35 + 35	1.94	1.94	2.71	2.71	3.6	9.3	9.5	800	2310	3430	10.7	10.2	9.8		
25 + 25 + 35 + 50	1.72	1.72	2.41	3.44	3.6	9.3	9.5	800	2310	3430	10.7	10.2	9.8		
25 + 35 + 35 + 35	1.79	2.50	2.50	2.50	3.6	9.3	9.5	800	2310	3430	10.7	10.2	9.8		

Indoor unit combination		Cooling capacity (kW)							Power consumption(W)			Standard current(A)			
		Room cooling capacity				Total capacity			Min.	Standard	Max.	220V	230V	240V	
		A	B	C	D	Min.	Standard	Max.							
Cooling operation	1 room	20	2.0	-	-	-	1.8	2.0	2.7	480	530	950	2.4	2.3	2.2
		25	2.5	-	-	-	1.8	2.5	3.2	480	730	1080	3.4	3.2	3.1
		35	3.5	-	-	-	1.8	3.5	3.7	480	1120	1240	5.1	4.9	4.7
		50	5.0	-	-	-	1.8	5.0	5.8	480	1710	2100	7.9	7.5	7.2
		60	6.0	-	-	-	1.8	6.0	6.7	480	2140	2700	9.8	9.4	9.0
	2 room	20 + 20	2.00	2.00	-	-	3.0	4.0	5.8	550	930	1910	4.3	4.1	3.9
		20 + 25	2.00	2.50	-	-	3.0	4.5	6.1	550	1170	2060	5.4	5.1	4.9
		20 + 35	2.00	3.50	-	-	3.0	5.5	6.6	550	1590	2320	7.3	7.0	6.7
		20 + 50	1.97	4.93	-	-	3.0	6.9	7.5	550	2200	2830	10.1	9.7	9.3
		20 + 60	1.85	5.55	-	-	3.0	7.4	7.5	550	2430	2830	11.2	10.7	10.2
		25 + 25	2.50	2.50	-	-	3.0	5.0	6.5	550	1360	2270	6.2	6.0	5.7
		25 + 35	2.46	3.44	-	-	3.0	5.9	6.8	550	1780	2470	8.2	7.8	7.5
		25 + 50	2.47	4.93	-	-	3.0	7.4	7.5	550	2430	2830	11.2	10.7	10.2
		25 + 60	2.18	5.22	-	-	3.0	7.4	7.5	550	2430	2830	11.2	10.7	10.2
		35 + 35	3.45	3.45	-	-	3.0	6.9	7.5	550	2200	2680	10.1	9.7	9.3
		35 + 50	3.05	4.35	-	-	3.0	7.4	7.5	550	2430	2830	11.2	10.7	10.2
		35 + 60	2.73	4.67	-	-	3.0	7.4	7.5	550	2430	2830	11.2	10.7	10.2
		50 + 50	3.70	3.70	-	-	3.0	7.4	7.5	550	2430	2830	11.2	10.7	10.2
		50 + 60	3.36	4.04	-	-	3.0	7.4	7.5	550	2430	2830	11.2	10.7	10.2
		60 + 60	3.70	3.70	-	-	3.0	7.4	7.5	550	2430	2830	11.2	10.7	10.2
	3 room	20 + 20 + 20	2.00	2.00	2.00	-	3.7	6.0	8.1	670	1450	2830	6.7	6.4	6.1
		20 + 20 + 25	2.00	2.00	2.50	-	3.7	6.5	8.1	670	1630	2830	7.5	7.2	6.9
		20 + 20 + 35	1.89	1.89	3.31	-	3.7	7.1	8.1	670	1950	2830	9.0	8.6	8.2
		20 + 20 + 50	1.73	1.73	4.33	-	3.7	7.8	8.1	670	2320	2830	10.7	10.2	9.8
		20 + 20 + 60	1.56	1.56	4.68	-	3.7	7.8	8.1	670	2320	2830	10.7	10.2	9.8
		20 + 25 + 25	1.94	2.43	2.43	-	3.7	6.8	8.1	670	1820	2830	8.4	8.0	7.7
		20 + 25 + 35	1.88	2.34	3.28	-	3.7	7.5	8.1	670	2130	2830	9.8	9.4	9.0
		20 + 25 + 50	1.64	2.05	4.11	-	3.7	7.8	8.1	670	2320	2830	10.7	10.2	9.8
		20 + 25 + 60	1.49	1.86	4.46	-	3.7	7.8	8.1	670	2320	2830	10.7	10.2	9.8



MULTI-SPLIT SYSTEM

Indoor unit combination		Cooling capacity (kW)							Power consumption(W)			Standard current(A)			
		Room cooling capacity				Total capacity			Min.	Standard	Max.	220V	230V	240V	
		A	B	C	D	Min.	Standard	Max.							
Cooling operation	3 room	20 + 35 + 35	1.73	3.03	3.03	-	3.7	7.8	8.1	670	2320	2830	10.7	10.2	9.8
		20 + 35 + 50	1.49	2.60	3.71	-	3.7	7.8	8.1	670	2320	2830	10.7	10.2	9.8
		20 + 35 + 60	1.36	2.37	4.07	-	3.7	7.8	8.1	670	2320	2830	10.7	10.2	9.8
		20 + 50 + 50	1.30	3.25	3.25	-	3.7	7.8	8.1	670	2320	2830	10.7	10.2	9.8
		20 + 50 + 60	1.20	3.00	3.60	-	3.7	7.8	8.1	670	2320	2830	10.7	10.2	9.8
		25 + 25 + 25	2.37	2.37	2.37	-	3.7	7.1	8.1	670	1950	2830	9.0	8.6	8.2
		25 + 25 + 35	2.29	2.29	3.21	-	3.7	7.8	8.1	670	2320	2830	10.7	10.2	9.8
		25 + 25 + 50	1.95	1.95	3.90	-	3.7	7.8	8.1	670	2320	2830	10.7	10.2	9.8
		25 + 25 + 60	1.77	1.77	4.25	-	3.7	7.8	8.1	670	2320	2830	10.7	10.2	9.8
		25 + 35 + 35	2.05	2.87	2.87	-	3.7	7.8	8.1	670	2320	2830	10.7	10.2	9.8
		25 + 35 + 50	1.77	2.48	3.55	-	3.7	7.8	8.1	670	2320	2830	10.7	10.2	9.8
		25 + 35 + 60	1.63	2.28	3.90	-	3.7	7.8	8.1	670	2320	2830	10.7	10.2	9.8
		25 + 50 + 50	1.56	3.12	3.12	-	3.7	7.8	8.1	670	2320	2830	10.7	10.2	9.8
		25 + 50 + 60	1.44	2.89	3.47	-	3.7	7.8	8.1	670	2320	2830	10.7	10.2	9.8
		35 + 35 + 35	2.60	2.60	2.60	-	3.7	7.8	8.1	670	2320	2830	10.7	10.2	9.8
	35 + 35 + 50	2.28	2.28	3.25	-	3.7	7.8	8.1	670	2320	2830	10.7	10.2	9.8	
	35 + 35 + 60	2.10	2.10	3.60	-	3.7	7.8	8.1	670	2320	2830	10.7	10.2	9.8	
	35 + 50 + 50	2.02	2.89	2.89	-	3.7	7.8	8.1	670	2320	2830	10.7	10.2	9.8	
	4 room	20 + 20 + 20 + 20	1.95	1.95	1.95	1.95	4.4	7.8	8.7	890	2180	2830	9.9	9.5	9.1
		20 + 20 + 20 + 25	1.84	1.84	1.84	2.29	4.4	7.8	8.7	890	2180	2830	9.9	9.5	9.1
		20 + 20 + 20 + 35	1.66	1.66	1.66	2.91	4.4	7.9	8.7	890	2200	2830	10.0	9.6	9.2
		20 + 20 + 20 + 50	1.44	1.44	1.44	3.59	4.4	7.9	8.7	890	2200	2830	10.0	9.6	9.2
		20 + 20 + 20 + 60	1.33	1.33	1.33	4.00	4.4	8.0	8.7	890	2220	2830	10.1	9.7	9.3
		20 + 20 + 25 + 25	1.76	1.76	2.19	2.19	4.4	7.9	8.7	890	2200	2830	10.0	9.6	9.2
		20 + 20 + 25 + 35	1.58	1.58	1.98	2.77	4.4	7.9	8.7	890	2200	2830	10.0	9.6	9.2
		20 + 20 + 25 + 50	1.37	1.37	1.72	3.43	4.4	7.9	8.7	890	2200	2830	10.0	9.6	9.2
		20 + 20 + 25 + 60	1.28	1.28	1.60	3.84	4.4	8.0	8.7	890	2220	2830	10.1	9.7	9.3
		20 + 20 + 35 + 35	1.44	1.44	2.51	2.51	4.4	7.9	8.7	890	2200	2830	10.0	9.6	9.2
		20 + 20 + 35 + 50	1.28	1.28	2.24	3.20	4.4	8.0	8.7	890	2220	2830	10.1	9.7	9.3
		20 + 20 + 35 + 60	1.19	1.19	2.07	3.56	4.4	8.0	8.7	890	2220	2830	10.1	9.7	9.3
		20 + 25 + 25 + 25	1.66	2.08	2.08	2.08	4.4	7.9	8.7	890	2200	2830	10.0	9.6	9.2
		20 + 25 + 25 + 35	1.50	1.88	1.88	2.63	4.4	7.9	8.7	890	2200	2830	10.0	9.6	9.2
		20 + 25 + 25 + 50	1.33	1.67	1.67	3.33	4.4	8.0	8.7	890	2220	2830	10.1	9.7	9.3
		20 + 25 + 25 + 60	1.23	1.54	1.54	3.69	4.4	8.0	8.7	890	2220	2830	10.1	9.7	9.3
		20 + 25 + 35 + 35	1.37	1.72	2.40	2.40	4.4	7.9	8.7	890	2200	2830	10.0	9.6	9.2
20 + 25 + 35 + 50		1.23	1.54	2.15	3.08	4.4	8.0	8.7	890	2220	2830	10.1	9.7	9.3	
20 + 35 + 35 + 35		1.28	2.24	2.24	2.24	4.4	8.0	8.7	890	2220	2830	10.1	9.7	9.3	
25 + 25 + 25 + 25		1.98	1.98	1.98	1.98	4.4	7.9	8.7	890	2200	2830	10.0	9.6	9.2	
25 + 25 + 25 + 35	1.80	1.80	1.80	2.51	4.4	7.9	8.7	890	2200	2830	10.0	9.6	9.2		
25 + 25 + 25 + 50	1.60	1.60	1.60	3.20	4.4	8.0	8.7	890	2220	2830	10.1	9.7	9.3		
25 + 25 + 25 + 60	1.48	1.48	1.48	3.56	4.4	8.0	8.7	890	2220	2830	10.1	9.7	9.3		
25 + 25 + 35 + 35	1.67	1.67	2.33	2.33	4.4	8.0	8.7	890	2220	2830	10.1	9.7	9.3		
25 + 25 + 35 + 50	1.48	1.48	2.07	2.96	4.4	8.0	8.7	890	2220	2830	10.1	9.7	9.3		
25 + 35 + 35 + 35	1.54	2.15	2.15	2.15	4.4	8.0	8.7	890	2220	2830	10.1	9.7	9.3		

SCM100ZM-S Table of Indoor unit combination only with SRK-ZSX type

Indoor unit combination		Heating capacity (kW)							Power consumption(W)			Standard current(A)					
		Room heating capacity					Total capacity		Min.	Standard	Max.	220V	230V	240V			
		A	B	C	D	E	F	Min.							Standard	Max.	
Heating operation	1 room	20	3.0	-	-	-	-	1.5	3.0	3.7	700	1010	1330	4.6	4.4	4.3	
		25	3.4	-	-	-	-	1.5	3.4	4.2	700	1150	1540	5.3	5.1	4.8	
		35	4.5	-	-	-	-	1.5	4.5	5.0	700	1540	1840	7.1	6.8	6.5	
		50	5.8	-	-	-	-	1.5	5.8	6.5	700	2000	2410	9.2	8.8	8.4	
		60	6.8	-	-	-	-	1.5	6.8	7.5	700	2360	2760	10.8	10.4	9.9	
	2 room	20+20	3.00	3.00	-	-	-	-	2.1	6.0	7.4	750	1510	1460	6.9	6.6	6.4
		20+25	2.84	3.56	-	-	-	-	2.1	6.4	7.9	750	1630	2210	7.5	7.2	6.9
		20+35	2.73	4.77	-	-	-	-	2.1	7.5	8.7	750	1950	2520	9.0	8.6	8.2
		20+50	2.51	6.29	-	-	-	-	2.1	8.8	10.2	750	2380	3220	10.9	10.5	10.0
		20+60	2.45	7.35	-	-	-	-	2.1	9.8	11.2	750	2780	3620	12.8	12.2	11.7
		25+25	3.40	3.40	-	-	-	-	2.1	6.8	8.4	750	1740	2420	8.0	7.6	7.3
		25+35	3.29	4.61	-	-	-	-	2.1	7.9	9.2	750	2100	2820	9.6	9.2	8.8
		25+50	3.07	6.13	-	-	-	-	2.1	9.2	10.7	750	2580	3610	11.8	11.3	10.9
		25+60	3.00	7.20	-	-	-	-	2.1	10.2	11.7	750	2980	3790	13.7	13.1	12.5
		35+35	4.50	4.50	-	-	-	-	2.1	9.0	10.0	750	2470	3210	11.3	10.8	10.4
		35+50	4.24	6.06	-	-	-	-	2.1	10.3	11.5	750	2980	3710	13.7	13.1	12.5
		35+60	4.16	7.14	-	-	-	-	2.1	11.3	12.5	750	3430	4100	15.7	15.1	14.4
		50+50	5.80	5.80	-	-	-	-	2.1	11.6	13.0	750	3580	4320	16.4	15.7	15.1
		50+60	5.45	6.55	-	-	-	-	2.1	12.0	13.5	750	3720	4520	17.1	16.3	15.7
		60+60	6.00	6.00	-	-	-	-	2.1	12.0	13.5	750	3720	4520	17.1	16.3	15.7
	3 room	20+20+20	3.00	3.00	3.00	-	-	-	3.2	9.0	11.1	780	2230	3350	10.2	9.8	9.4
		20+20+25	2.89	2.89	3.62	-	-	-	3.2	9.4	11.6	780	2350	3550	10.8	10.3	9.9
		20+20+35	2.80	2.80	4.90	-	-	-	3.2	10.5	12.4	780	2710	3820	12.4	11.9	11.4
		20+20+50	2.62	2.62	6.56	-	-	-	3.2	11.8	13.5	780	3210	4190	14.7	14.1	13.5
		20+20+60	2.40	2.40	7.20	-	-	-	3.2	12.0	13.5	780	3350	4190	15.4	14.7	14.1
		20+25+25	2.80	3.50	3.50	-	-	-	3.2	9.8	12.1	780	2510	3720	11.5	11.0	10.6
	20+25+35	2.73	3.41	4.77	-	-	-	3.2	10.9	12.9	780	2910	3990	13.4	12.8	12.2	

COMBINATIONS

Indoor unit combination		Heating capacity (kW)									Power consumption(W)			Standard current(A)			
		Room heating capacity						Total capacity			Min.	Standard	Max.	220V	230V	240V	
		A	B	C	D	E	F	Min.	Standard	Max.							
3 room	20+25+50	2.53	3.16	6.32	-	-	-	3.2	12.0	13.5	780	3350	4190	15.4	14.7	14.1	
	20+25+60	2.29	2.86	6.86	-	-	-	3.2	12.0	13.5	780	3350	4190	15.4	14.7	14.1	
	20+35+35	2.67	4.67	4.67	-	-	-	3.2	12.0	13.5	780	3360	4190	15.4	14.8	14.1	
	20+35+50	2.29	4.00	5.71	-	-	-	3.2	12.0	13.5	780	3350	4190	15.4	14.7	14.1	
	20+35+60	2.09	3.65	6.26	-	-	-	3.2	12.0	13.5	780	3340	4190	15.3	14.7	14.1	
	20+50+50	2.00	5.00	5.00	-	-	-	3.2	12.0	13.5	780	3340	4190	15.3	14.7	14.1	
	20+50+60	1.85	4.62	5.54	-	-	-	3.2	12.0	13.5	780	3340	4190	15.3	14.7	14.1	
	20+60+60	1.71	5.14	5.14	-	-	-	3.2	12.0	13.5	780	3330	4190	15.3	14.6	14.0	
	25+25+25	3.40	3.40	3.40	-	-	-	3.2	10.2	12.6	780	2710	3880	12.4	11.9	11.4	
	25+25+35	3.32	3.32	4.65	-	-	-	3.2	11.3	13.4	780	3110	4120	14.3	13.7	13.1	
	25+25+50	3.00	3.00	6.00	-	-	-	3.2	12.0	13.5	780	3350	4190	15.4	14.7	14.1	
	25+25+60	2.73	2.73	6.55	-	-	-	3.2	12.0	13.5	780	3350	4190	15.4	14.7	14.1	
	25+35+35	3.16	4.42	4.42	-	-	-	3.2	12.0	13.5	780	3350	4190	15.4	14.7	14.1	
	25+35+50	2.73	3.82	5.45	-	-	-	3.2	12.0	13.5	780	3350	4190	15.4	14.7	14.1	
	25+35+60	2.50	3.50	6.00	-	-	-	3.2	12.0	13.5	780	3340	4190	15.3	14.7	14.1	
	25+50+50	2.40	4.80	4.80	-	-	-	3.2	12.0	13.5	780	3340	4190	15.3	14.7	14.1	
	25+50+60	2.22	4.44	5.33	-	-	-	3.2	12.0	13.5	780	3330	4190	15.3	14.6	14.0	
	25+60+60	2.07	4.97	4.97	-	-	-	3.2	12.0	13.5	780	3330	4190	15.3	14.6	14.0	
	35+35+35	4.00	4.00	4.00	-	-	-	3.2	12.0	13.5	780	3350	4190	15.4	14.7	14.1	
	35+35+50	3.50	3.50	5.00	-	-	-	3.2	12.0	13.5	780	3340	4190	15.3	14.7	14.1	
	35+35+60	3.23	3.23	5.54	-	-	-	3.2	12.0	13.5	780	3340	4190	15.3	14.7	14.1	
	35+50+50	3.11	4.44	4.44	-	-	-	3.2	12.0	13.5	780	3330	4190	15.3	14.6	14.0	
	35+50+60	2.90	4.14	4.97	-	-	-	3.2	12.0	13.5	780	3330	4190	15.3	14.6	14.0	
	35+60+60	2.71	4.65	4.65	-	-	-	3.2	12.0	13.5	780	3320	4190	15.2	14.6	14.0	
	50+50+50	4.00	4.00	4.00	-	-	-	3.2	12.0	13.5	780	3330	4190	15.3	14.6	14.0	
	50+50+60	3.75	3.75	4.50	-	-	-	3.2	12.0	13.5	780	3320	4190	15.2	14.6	14.0	
	4 room	20+20+20+20	3.00	3.00	3.00	3.00	-	-	3.6	12.0	13.5	950	3230	3840	14.7	14.1	13.5
		20+20+20+25	2.82	2.82	2.82	3.53	-	-	3.6	12.0	13.5	950	3230	3840	14.7	14.1	13.5
		20+20+20+35	2.53	2.53	2.53	4.42	-	-	3.6	12.0	13.5	950	3230	3840	14.7	14.1	13.5
		20+20+20+50	2.18	2.18	2.18	5.45	-	-	3.6	12.0	13.5	950	3220	3840	14.7	14.0	13.4
		20+20+20+60	2.00	2.00	2.00	6.00	-	-	3.6	12.0	13.5	950	3220	3840	14.7	14.0	13.4
		20+20+25+25	2.67	2.67	3.33	3.33	-	-	3.6	12.0	13.5	950	3230	3840	14.7	14.1	13.5
		20+20+25+35	2.40	2.40	3.00	4.20	-	-	3.6	12.0	13.5	950	3220	3840	14.7	14.0	13.4
20+20+25+50		2.09	2.09	2.61	5.22	-	-	3.6	12.0	13.5	950	3220	3840	14.7	14.0	13.4	
20+20+25+60		1.92	1.92	2.40	5.76	-	-	3.6	12.0	13.5	950	3340	3840	15.2	14.5	13.9	
20+20+35+35		2.18	2.18	3.82	3.82	-	-	3.6	12.0	13.5	950	3220	3840	14.7	14.0	13.4	
20+20+35+50		1.92	1.92	3.36	4.80	-	-	3.6	12.0	13.5	950	3340	3840	15.2	14.5	13.9	
20+20+35+60		1.78	1.78	3.11	5.33	-	-	3.6	12.0	13.5	950	3210	3840	14.6	14.0	13.4	
20+20+50+50		1.71	1.71	4.29	4.29	-	-	3.6	12.0	13.5	950	3210	3840	14.6	14.0	13.4	
20+20+50+60		1.60	1.60	4.00	4.80	-	-	3.6	12.0	13.5	950	3210	3840	14.6	14.0	13.4	
20+20+60+60		1.50	1.50	4.50	4.50	-	-	3.6	12.0	13.5	950	3200	3840	14.6	13.9	13.3	
20+25+25+25		2.53	3.16	3.16	3.16	-	-	3.6	12.0	13.5	950	3230	3840	14.7	14.1	13.5	
20+25+25+35		2.29	2.86	2.86	4.00	-	-	3.6	12.0	13.5	950	3220	3840	14.7	14.0	13.4	
20+25+25+50		2.00	2.50	2.50	5.00	-	-	3.6	12.0	13.5	950	3220	3840	14.7	14.0	13.4	
20+25+25+60		1.85	2.31	2.31	5.54	-	-	3.6	12.0	13.5	950	3340	3840	15.2	14.5	13.9	
20+25+35+35		2.09	2.61	3.65	3.65	-	-	3.6	12.0	13.5	950	3220	3840	14.7	14.0	13.4	
20+25+35+50		1.85	2.31	3.23	4.62	-	-	3.6	12.0	13.5	950	3340	3840	15.2	14.5	13.9	
20+25+35+60		1.71	2.14	3.00	5.14	-	-	3.6	12.0	13.5	950	3210	3840	14.6	14.0	13.4	
20+25+50+50		1.66	2.07	4.14	4.14	-	-	3.6	12.0	13.5	950	3210	3840	14.6	14.0	13.4	
20+25+50+60		1.55	1.94	3.87	4.65	-	-	3.6	12.0	13.5	950	3200	3840	14.6	13.9	13.3	
20+35+35+35		1.92	3.36	3.36	3.36	-	-	3.6	12.0	13.5	950	3340	3840	15.2	14.5	13.9	
20+35+35+50		1.71	3.00	3.00	4.29	-	-	3.6	12.0	13.5	950	3210	3840	14.6	14.0	13.4	
20+35+35+60		1.60	2.80	2.80	4.80	-	-	3.6	12.0	13.5	950	3210	3840	14.6	14.0	13.4	
20+35+50+50		1.55	2.71	3.87	3.87	-	-	3.6	12.0	13.5	950	3200	3840	14.6	13.9	13.3	
25+25+25+25		3.00	3.00	3.00	3.00	-	-	3.6	12.0	13.5	950	3220	3840	14.7	14.0	13.4	
25+25+25+35		2.73	2.73	2.73	3.82	-	-	3.6	12.0	13.5	950	3220	3840	14.7	14.0	13.4	
25+25+25+50		2.40	2.40	2.40	4.80	-	-	3.6	12.0	13.5	950	3340	3840	15.2	14.5	13.9	
25+25+25+60		2.22	2.22	2.22	5.33	-	-	3.6	12.0	13.5	950	3210	3840	14.6	14.0	13.4	
25+25+35+35		2.50	2.50	3.50	3.50	-	-	3.6	12.0	13.5	950	3220	3840	14.7	14.0	13.4	
25+25+35+50	2.22	2.22	3.11	4.44	-	-	3.6	12.0	13.5	950	3210	3840	14.6	14.0	13.4		
25+25+35+60	2.07	2.07	2.90	4.97	-	-	3.6	12.0	13.5	950	3210	3840	14.6	14.0	13.4		
25+25+50+50	2.00	2.00	4.00	4.00	-	-	3.6	12.0	13.5	950	3210	3840	14.6	14.0	13.4		
25+25+50+60	1.88	1.88	3.75	4.50	-	-	3.6	12.0	13.5	950	3200	3840	14.6	13.9	13.3		
25+35+35+35	2.31	3.23	3.23	3.23	-	-	3.6	12.0	13.5	950	3340	3840	15.2	14.5	13.9		
25+35+35+50	2.07	2.90	2.90	4.14	-	-	3.6	12.0	13.5	950	3210	3840	14.6	14.0	13.4		
25+35+35+60	1.94	2.71	2.71	4.65	-	-	3.6	12.0	13.5	950	3200	3840	14.6	13.9	13.3		
25+35+50+50	1.88	2.63	3.75	3.75	-	-	3.6	12.0	13.5	950	3200	3840	14.6	13.9	13.3		
35+35+35+35	3.00	3.00	3.00	3.00	-	-	3.6	12.0	13.5	950	3210	3840	14.6	14.0	13.4		
35+35+35+50	2.71	2.71	2.71	3.87	-	-	3.6	12.0	13.5	950	3200	3840	14.6	13.9	13.3		
5 room	20+20+20+20+20	2.40	2.40	2.40	2.40	2.40	-	4.0	12.0	13.5	1050	2930	3400	13.3	12.8	12.2	
	20+20+20+20+25	2.29	2.29	2.29	2.29	2.86	-	4.0	12.0	13.5	1050	2920	3400	13.3	12.7	12.2	
	20+20+20+20+35	2.09	2.09	2.09	2.09	3.65	-	4.0	12.0	13.5	1050	2920	3400	13.3	12.7	12.2	
	20+20+20+20+50	1.85	1.85	1.85	1.85	4.62	-	4.0	12.0	13.5	1050	2910	3400	13.2	12.7	12.1	
	20+20+20+20+60	1.71	1.71	1.71	1.71	5.14	-	4.0	12.0	13.5	1050	2910	3400	13.2	12.7	12.1	
	20+20+20+25+25	2.18	2.18	2.18	2.73	2.73	-	4.0	12.0	13.5	1050	2920	3400	13.3	12.7	12.2	
	20+20+20+25+35	2.00	2.00	2.00	2.50	3.50	-	4.0	12.0	13.5	1050	2920	3400	13.3	12.7	12.2	
20+20+20+25+50	1.78	1.78	1.78	2.22	4.44	-	4.0	12.0	13.5	1050	2910	3400	13.2	12.7	12.1		



MULTI-SPLIT SYSTEM

Indoor unit combination			Heating capacity (kW)									Power consumption(W)			Standard current(A)		
			Room heating capacity						Total capacity			Min.	Standard	Max.	220V	230V	240V
			A	B	C	D	E	F	Min.	Standard	Max.						
Heating operation	5 room	20+20+20+25+60	1.66	1.66	1.66	2.07	4.97	-	4.0	12.0	13.5	1050	2910	3400	13.2	12.7	12.1
		20+20+20+35+35	1.85	1.85	1.85	3.23	3.23	-	4.0	12.0	13.5	1050	2910	3400	13.2	12.7	12.1
		20+20+20+35+50	1.66	1.66	1.66	2.90	4.14	-	4.0	12.0	13.5	1050	2910	3400	13.2	12.7	12.1
		20+20+20+35+60	1.55	1.55	1.55	2.71	4.65	-	4.0	12.0	13.5	1050	2900	3400	13.2	12.6	12.1
		20+20+20+50+50	1.50	1.50	1.50	3.75	3.75	-	4.0	12.0	13.5	1050	2900	3400	13.2	12.6	12.1
		20+20+25+25+25	2.09	2.09	2.61	2.61	2.61	-	4.0	12.0	13.5	1050	2920	3400	13.3	12.7	12.2
		20+20+25+25+35	1.92	1.92	2.40	2.40	3.36	-	4.0	12.0	13.5	1050	2910	3400	13.2	12.7	12.1
		20+20+25+25+50	1.71	1.71	2.14	2.14	4.29	-	4.0	12.0	13.5	1050	2910	3400	13.2	12.7	12.1
		20+20+25+25+60	1.60	1.60	2.00	2.00	4.80	-	4.0	12.0	13.5	1050	2910	3400	13.2	12.7	12.1
		20+20+25+35+35	1.78	1.78	2.22	3.11	3.11	-	4.0	12.0	13.5	1050	2910	3400	13.2	12.7	12.1
		20+20+25+35+50	1.60	1.60	2.00	2.80	4.00	-	4.0	12.0	13.5	1050	2910	3400	13.2	12.7	12.1
		20+20+25+35+60	1.50	1.50	1.88	2.63	4.50	-	4.0	12.0	13.5	1050	2900	3400	13.2	12.6	12.1
		20+20+35+35+35	1.66	1.66	2.90	2.90	2.90	-	4.0	12.0	13.5	1050	2910	3400	13.2	12.7	12.1
		20+20+35+35+50	1.50	1.50	2.63	2.63	3.75	-	4.0	12.0	13.5	1050	2900	3400	13.2	12.6	12.1
		20+25+25+25+25	2.00	2.50	2.50	2.50	2.50	-	4.0	12.0	13.5	1050	2920	3400	13.3	12.7	12.2
		20+25+25+25+35	1.85	2.31	2.31	2.31	3.23	-	4.0	12.0	13.5	1050	2910	3400	13.2	12.7	12.1
		20+25+25+25+50	1.66	2.07	2.07	2.07	4.14	-	4.0	12.0	13.5	1050	2910	3400	13.2	12.7	12.1
		20+25+25+25+60	1.55	1.94	1.94	1.94	4.65	-	4.0	12.0	13.5	1050	2900	3400	13.2	12.6	12.1
		20+25+25+35+35	1.71	2.14	2.14	3.00	3.00	-	4.0	12.0	13.5	1050	2910	3400	13.2	12.7	12.1
		20+25+25+35+50	1.55	1.94	1.94	2.71	3.87	-	4.0	12.0	13.5	1050	2900	3400	13.2	12.6	12.1
		20+25+35+35+35	1.60	2.00	2.80	2.80	2.80	-	4.0	12.0	13.5	1050	2910	3400	13.2	12.7	12.1
		20+35+35+35+35	1.50	2.63	2.63	2.63	2.63	-	4.0	12.0	13.5	1050	2900	3400	13.2	12.6	12.1
		25+25+25+25+25	2.40	2.40	2.40	2.40	2.40	-	4.0	12.0	13.5	1050	2910	3400	13.2	12.7	12.1
		25+25+25+25+35	2.22	2.22	2.22	2.22	3.11	-	4.0	12.0	13.5	1050	2910	3400	13.2	12.7	12.1
		25+25+25+25+50	2.00	2.00	2.00	2.00	4.00	-	4.0	12.0	13.5	1050	2910	3400	13.2	12.7	12.1
		25+25+25+25+60	1.88	1.88	1.88	1.88	4.50	-	4.0	12.0	13.5	1050	2900	3400	13.2	12.6	12.1
25+25+25+35+35	2.07	2.07	2.07	2.90	2.90	-	4.0	12.0	13.5	1050	2910	3400	13.2	12.7	12.1		
25+25+25+35+50	1.88	1.88	1.88	2.63	3.75	-	4.0	12.0	13.5	1050	2900	3400	13.2	12.6	12.1		
25+25+35+35+35	1.94	1.94	2.71	2.71	2.71	-	4.0	12.0	13.5	1050	2900	3400	13.2	12.6	12.1		

Indoor unit combination			Cooling capacity (kW)									Power consumption(W)			Standard current(A)		
			Room cooling capacity						Total capacity			Min.	Standard	Max.	220V	230V	240V
			A	B	C	D	E	F	Min.	Standard	Max.						
Cooling operation	1 room	20	2.0	-	-	-	-	1.8	2.0	2.8	650	750	1100	3.4	3.3	3.2	
		25	2.5	-	-	-	-	1.8	2.5	3.4	650	950	1350	4.4	4.2	4.0	
		35	3.5	-	-	-	-	1.8	3.5	3.9	650	1400	1600	6.4	6.1	5.9	
		50	5.0	-	-	-	-	1.8	5.0	6.1	650	2000	2500	9.2	8.8	8.4	
		60	6.0	-	-	-	-	1.8	6.0	7.0	650	2450	3000	11.2	10.8	10.3	
	2 room	20+20	2.00	2.00	-	-	-	3.0	4.0	5.6	740	910	1460	4.2	4.0	3.8	
		20+25	2.00	2.50	-	-	-	3.0	4.5	6.2	740	1050	1820	4.8	4.6	4.4	
		20+35	2.00	3.50	-	-	-	3.0	5.5	6.7	740	1430	2020	6.6	6.3	6.0	
		20+50	2.00	5.00	-	-	-	3.0	7.0	8.9	740	2180	2820	10.0	9.6	9.2	
		20+60	2.00	6.00	-	-	-	3.0	8.0	9.8	740	2530	3360	11.6	11.1	10.6	
		25+25	2.50	2.50	-	-	-	3.0	5.0	6.8	740	1350	2200	6.2	5.9	5.7	
		25+35	2.50	3.50	-	-	-	3.0	6.0	7.3	740	1720	2320	7.9	7.6	7.2	
		25+50	2.50	5.00	-	-	-	3.0	7.5	9.5	740	2350	3220	10.8	10.3	9.9	
		25+60	2.50	6.00	-	-	-	3.0	8.5	9.8	740	2680	3360	12.3	11.8	11.3	
		35+35	3.50	3.50	-	-	-	3.0	7.0	7.8	740	2180	2820	10.0	9.6	9.2	
		35+50	3.50	5.00	-	-	-	3.0	8.5	10.0	740	2680	3620	12.3	11.8	11.3	
		35+60	3.50	6.00	-	-	-	3.0	9.5	10.9	740	3120	3990	14.3	13.7	13.1	
		50+50	5.00	5.00	-	-	-	3.0	10.0	12.0	740	3350	4400	15.4	14.7	14.1	
		50+60	4.55	5.45	-	-	-	3.0	10.0	12.0	740	3350	4400	15.4	14.7	14.1	
		60+60	5.00	5.00	-	-	-	3.0	10.0	12.0	740	3340	4400	15.3	14.7	14.1	
	3 room	20+20+20	2.00	2.00	2.00	-	-	3.7	6.0	8.4	880	1460	2560	6.7	6.4	6.1	
		20+20+25	2.00	2.00	2.50	-	-	3.7	6.5	9.0	880	1650	2700	7.6	7.2	6.9	
		20+20+35	2.00	2.00	3.50	-	-	3.7	7.5	9.5	880	1980	3120	9.1	8.7	8.3	
		20+20+50	2.00	2.00	5.00	-	-	3.7	9.0	11.7	880	2600	4120	11.9	11.4	10.9	
		20+20+60	2.00	2.00	6.00	-	-	3.7	10.0	12.0	880	3120	4250	14.3	13.7	13.1	
		20+25+25	2.00	2.50	2.50	-	-	3.7	7.0	9.6	880	1850	3210	8.5	8.1	7.8	
20+25+35		2.00	2.50	3.50	-	-	3.7	8.0	10.1	880	2320	3630	10.7	10.2	9.8		
20+25+50		2.00	2.50	5.00	-	-	3.7	9.5	12.0	880	2980	4250	13.7	13.1	12.5		
20+25+60		1.90	2.38	5.71	-	-	3.7	10.0	12.0	880	3120	4250	14.3	13.7	13.1		
20+35+35		2.00	3.50	3.50	-	-	3.7	9.0	10.6	880	2780	3750	12.8	12.2	11.7		
20+35+50		1.90	3.33	4.76	-	-	3.7	10.0	12.0	880	3120	4250	14.3	13.7	13.1		
20+35+60		1.74	3.04	5.22	-	-	3.7	10.0	12.0	880	3110	4250	14.3	13.7	13.1		
20+50+50		1.67	4.17	4.17	-	-	3.7	10.0	12.0	880	3110	4250	14.3	13.7	13.1		
20+50+60		1.54	3.85	4.62	-	-	3.7	10.0	12.0	880	3110	4250	14.3	13.7	13.1		
20+60+60		1.43	4.29	4.29	-	-	3.7	10.0	12.0	880	3100	4250	14.2	13.6	13.0		
25+25+25		2.50	2.50	2.50	-	-	3.7	7.5	10.2	880	2030	3640	9.3	8.9	8.5		
25+25+35		2.50	2.50	3.50	-	-	3.7	8.5	10.7	880	2520	3900	11.6	11.1	10.6		
25+25+50		2.50	2.50	5.00	-	-	3.7	10.0	12.0	880	3120	4250	14.3	13.7	13.1		
25+25+60		2.27	2.27	5.45	-	-	3.7	10.0	12.0	880	3120	4250	14.3	13.7	13.1		
25+35+35		2.50	3.50	3.50	-	-	3.7	9.5	11.2	880	2980	3990	13.7	13.1	12.5		
25+35+50	2.27	3.18	4.55	-	-	3.7	10.0	12.0	880	3120	4250	14.3	13.7	13.1			
25+35+60	2.08	2.92	5.00	-	-	3.7	10.0	12.0	880	3110	4250	14.3	13.7	13.1			
25+50+50	2.00	4.00	4.00	-	-	3.7	10.0	12.0	880	3110	4250	14.3	13.7	13.1			
25+50+60	1.85	3.70	4.44	-	-	3.7	10.0	12.0	880	3100	4250	14.2	13.6	13.0			

COMBINATIONS

Indoor unit combination		Cooling capacity (kW)									Power consumption(W)			Standard current(A)		
		Room cooling capacity						Total capacity			Min.	Standard	Max.	220V	230V	240V
		A	B	C	D	E	F	Min.	Standard	Max.						
3 room	25+60+60	1.72	4.14	4.14	-	-	-	3.7	10.0	12.0	880	3100	4250	14.2	13.6	13.0
	35+35+35	3.33	3.33	3.33	-	-	-	3.7	10.0	11.7	880	3120	4180	14.3	13.7	13.1
	35+35+50	2.92	2.92	4.17	-	-	-	3.7	10.0	12.0	880	3110	4250	14.3	13.7	13.1
	35+35+60	2.69	2.69	4.62	-	-	-	3.7	10.0	12.0	880	3110	4250	14.3	13.7	13.1
	35+50+50	2.59	3.70	3.70	-	-	-	3.7	10.0	12.0	880	3100	4250	14.2	13.6	13.0
	35+50+60	2.41	3.45	4.14	-	-	-	3.7	10.0	12.0	880	3100	4250	14.2	13.6	13.0
	35+60+60	2.26	3.87	3.87	-	-	-	3.7	10.0	12.0	880	3090	4250	14.2	13.6	13.0
	50+50+50	3.33	3.33	3.33	-	-	-	3.7	10.0	12.0	880	3100	4250	14.2	13.6	13.0
	50+50+60	3.13	3.13	3.75	-	-	-	3.7	10.0	12.0	880	3090	4250	14.2	13.6	13.0
	20+20+20+20	2.00	2.00	2.00	2.00	-	-	4.4	8.0	11.2	1100	2050	3680	9.3	8.9	8.6
	20+20+20+25	2.00	2.00	2.00	2.50	-	-	4.4	8.5	11.8	1100	2320	3890	10.6	10.1	9.7
	20+20+20+35	2.00	2.00	2.00	3.50	-	-	4.4	9.5	12.0	1100	2820	4050	12.8	12.3	11.8
20+20+20+50	1.82	1.82	1.82	4.55	-	-	4.4	10.0	12.0	1100	3020	4050	13.7	13.1	12.6	
20+20+20+60	1.67	1.67	1.67	5.00	-	-	4.4	10.0	12.0	1100	3020	4050	13.7	13.1	12.6	
20+20+25+25	2.00	2.00	2.50	2.50	-	-	4.4	9.0	12.0	1100	2520	4050	11.5	11.0	10.5	
20+20+25+35	2.00	2.00	2.50	3.50	-	-	4.4	10.0	12.0	1100	3030	4050	13.8	13.2	12.6	
20+20+25+50	1.74	1.74	2.17	4.35	-	-	4.4	10.0	12.0	1100	3020	4050	13.7	13.1	12.6	
20+20+25+60	1.60	1.60	2.00	4.80	-	-	4.4	10.0	12.0	1100	3010	4050	13.7	13.1	12.6	
20+20+35+35	1.82	1.82	3.18	3.18	-	-	4.4	10.0	12.0	1100	3020	4050	13.7	13.1	12.6	
20+20+35+50	1.60	1.60	2.80	4.00	-	-	4.4	10.0	12.0	1100	3010	4050	13.7	13.1	12.6	
20+20+35+60	1.48	1.48	2.59	4.44	-	-	4.4	10.0	12.0	1100	3010	4050	13.7	13.1	12.6	
20+20+50+50	1.43	1.43	3.57	3.57	-	-	4.4	10.0	12.0	1100	3010	4050	13.7	13.1	12.6	
20+20+50+60	1.33	1.33	3.33	4.00	-	-	4.4	10.0	12.0	1100	3000	4050	13.7	13.1	12.5	
20+20+60+60	1.25	1.25	3.75	3.75	-	-	4.4	10.0	12.0	1100	2990	4050	13.6	13.0	12.5	
20+25+25+25	2.00	2.50	2.50	2.50	-	-	4.4	9.5	12.0	1100	2820	4050	12.8	12.3	11.8	
20+25+25+35	1.90	2.38	2.38	3.33	-	-	4.4	10.0	12.0	1100	3030	4050	13.8	13.2	12.6	
20+25+25+50	1.67	2.08	2.08	4.17	-	-	4.4	10.0	12.0	1100	3020	4050	13.7	13.1	12.6	
20+25+25+60	1.54	1.92	1.92	4.62	-	-	4.4	10.0	12.0	1100	3010	4050	13.7	13.1	12.6	
20+25+35+35	1.74	2.17	3.04	3.04	-	-	4.4	10.0	12.0	1100	3020	4050	13.7	13.1	12.6	
20+25+35+50	1.54	1.92	2.69	3.85	-	-	4.4	10.0	12.0	1100	3010	4050	13.7	13.1	12.6	
20+25+35+60	1.43	1.79	2.50	4.29	-	-	4.4	10.0	12.0	1100	3010	4050	13.7	13.1	12.6	
20+25+50+50	1.38	1.72	3.45	3.45	-	-	4.4	10.0	12.0	1100	3000	4050	13.7	13.1	12.5	
20+25+50+60	1.29	1.61	3.23	3.87	-	-	4.4	10.0	12.0	1100	3000	4050	13.7	13.1	12.5	
20+25+60+60	1.21	1.52	3.64	3.64	-	-	4.4	10.0	12.0	1100	2990	4050	13.6	13.0	12.5	
20+35+35+35	1.60	2.80	2.80	2.80	-	-	4.4	10.0	12.0	1100	3010	4050	13.7	13.1	12.6	
20+35+35+50	1.43	2.50	2.50	3.57	-	-	4.4	10.0	12.0	1100	3010	4050	13.7	13.1	12.6	
20+35+35+60	1.33	2.33	2.33	4.00	-	-	4.4	10.0	12.0	1100	3000	4050	13.7	13.1	12.5	
20+35+50+50	1.29	2.26	3.23	3.23	-	-	4.4	10.0	12.0	1100	3000	4050	13.7	13.1	12.5	
25+25+25+25	2.50	2.50	2.50	2.50	-	-	4.4	10.0	12.0	1100	3030	4050	13.8	13.2	12.6	
25+25+25+35	2.27	2.27	2.27	3.18	-	-	4.4	10.0	12.0	1100	3020	4050	13.7	13.1	12.6	
25+25+25+50	2.00	2.00	2.00	4.00	-	-	4.4	10.0	12.0	1100	3010	4050	13.7	13.1	12.6	
25+25+25+60	1.85	1.85	1.85	4.44	-	-	4.4	10.0	12.0	1100	3010	4050	13.7	13.1	12.6	
25+25+35+35	2.08	2.08	2.92	2.92	-	-	4.4	10.0	12.0	1100	3020	4050	13.7	13.1	12.6	
25+25+35+50	1.85	1.85	2.59	3.70	-	-	4.4	10.0	12.0	1100	3010	4050	13.7	13.1	12.6	
25+25+35+60	1.72	1.72	2.41	4.14	-	-	4.4	10.0	12.0	1100	3000	4050	13.7	13.1	12.5	
25+25+50+50	1.67	1.67	3.33	3.33	-	-	4.4	10.0	12.0	1100	3000	4050	13.7	13.1	12.5	
25+25+50+60	1.56	1.56	3.13	3.75	-	-	4.4	10.0	12.0	1100	2990	4050	13.6	13.0	12.5	
25+35+35+35	1.92	2.69	2.69	2.69	-	-	4.4	10.0	12.0	1100	3010	4050	13.7	13.1	12.6	
25+35+35+50	1.72	2.41	2.41	3.45	-	-	4.4	10.0	12.0	1100	3000	4050	13.7	13.1	12.5	
25+35+35+60	1.61	2.26	2.26	3.87	-	-	4.4	10.0	12.0	1100	3000	4050	13.7	13.1	12.5	
25+35+50+50	1.56	2.19	3.13	3.13	-	-	4.4	10.0	12.0	1100	2990	4050	13.6	13.0	12.5	
35+35+35+35	2.50	2.50	2.50	2.50	-	-	4.4	10.0	12.0	1100	3010	4050	13.7	13.1	12.6	
35+35+35+50	2.26	2.26	2.26	3.23	-	-	4.4	10.0	12.0	1100	3000	4050	13.7	13.1	12.5	
5 room	20+20+20+20+20	2.00	2.00	2.00	2.00	2.00	-	5.1	10.0	12.0	1210	2860	4030	13.0	12.4	11.9
	20+20+20+20+25	1.90	1.90	1.90	1.90	2.38	-	5.1	10.0	12.0	1210	2860	4030	13.0	12.4	11.9
	20+20+20+20+35	1.74	1.74	1.74	1.74	3.04	-	5.1	10.0	12.0	1210	2850	4030	13.0	12.4	11.9
	20+20+20+20+50	1.54	1.54	1.54	1.54	3.85	-	5.1	10.0	12.0	1210	2840	4030	12.9	12.4	11.8
	20+20+20+20+60	1.43	1.43	1.43	1.43	4.29	-	5.1	10.0	12.0	1210	2840	4030	12.9	12.4	11.8
	20+20+20+25+25	1.82	1.82	1.82	2.27	2.27	-	5.1	10.0	12.0	1210	2860	4030	13.0	12.4	11.9
	20+20+20+25+35	1.67	1.67	1.67	2.08	2.92	-	5.1	10.0	12.0	1210	2850	4030	13.0	12.4	11.9
	20+20+20+25+50	1.48	1.48	1.48	1.85	3.70	-	5.1	10.0	12.0	1210	2840	4030	12.9	12.4	11.8
	20+20+20+25+60	1.38	1.38	1.38	1.72	4.14	-	5.1	10.0	12.0	1210	2840	4030	12.9	12.4	11.8
	20+20+20+35+35	1.54	1.54	1.54	2.69	2.69	-	5.1	10.0	12.0	1210	2840	4030	12.9	12.4	11.8
	20+20+20+35+50	1.38	1.38	1.38	2.41	3.45	-	5.1	10.0	12.0	1210	2840	4030	12.9	12.4	11.8
	20+20+20+35+60	1.29	1.29	1.29	2.26	3.87	-	5.1	10.0	12.0	1210	2830	4030	12.9	12.3	11.8
	20+20+20+50+50	1.25	1.25	1.25	3.13	3.13	-	5.1	10.0	12.0	1210	2830	4030	12.9	12.3	11.8
	20+20+25+25+25	1.74	1.74	2.17	2.17	2.17	-	5.1	10.0	12.0	1210	2850	4030	13.0	12.4	11.9
	20+20+25+25+35	1.60	1.60	2.00	2.00	2.80	-	5.1	10.0	12.0	1210	2850	4030	13.0	12.4	11.9
	20+20+25+25+50	1.43	1.43	1.79	1.79	3.57	-	5.1	10.0	12.0	1210	2840	4030	12.9	12.4	11.8
	20+20+25+25+60	1.33	1.33	1.67	1.67	4.00	-	5.1	10.0	12.0	1210	2840	4030	12.9	12.4	11.8
	20+20+25+35+35	1.48	1.48	1.85	2.59	2.59	-	5.1	10.0	12.0	1210	2840	4030	12.9	12.4	11.8
	20+20+25+35+50	1.33	1.33	1.67	2.33	3.33	-	5.1	10.0	12.0	1210	2840	4030	12.9	12.4	11.8
	20+20+25+35+60	1.25	1.25	1.56	2.19	3.75	-	5.1	10.0	12.0	1210	2830	4030	12.9	12.3	11.8
	20+20+35+35+35	1.38	1.38	2.41	2.41	2.41	-	5.1	10.0	12.0	1210	2840	4030	12.9	12.4	11.8
	20+20+35+35+50	1.25	1.25	2.19	2.19	3.13	-	5.1	10.0	12.0	1210	2830	4030	12.9	12.3	11.8
	20+25+25+25+25	1.67	2.08	2.08	2.08	2.08	-	5.1	10.0	12.0	1210	2850	4030	13.0	12.4	11.9
	20+25+25+25+35	1.54	1.92	1.92	1.92	2.69	-	5.1	10.0	12.0	1210	2840	4030	12.9	12.4	11.8



MULTI-SPLIT SYSTEM

Indoor unit combination		Cooling capacity (kW)									Power consumption(W)			Standard current(A)			
		Room cooling capacity						Total capacity			Min.	Standard	Max.	220V	230V	240V	
		A	B	C	D	E	F	Min.	Standard	Max.							
Cooling operation	5 room	20+25+25+25+50	1.38	1.72	1.72	1.72	3.45	-	5.1	10.0	12.0	1210	2840	4030	12.9	12.4	11.8
		20+25+25+25+60	1.29	1.61	1.61	1.61	3.87	-	5.1	10.0	12.0	1210	2830	4030	12.9	12.3	11.8
		20+25+25+35+35	1.43	1.79	1.79	2.50	2.50	-	5.1	10.0	12.0	1210	2840	4030	12.9	12.4	11.8
		20+25+25+35+50	1.29	1.61	1.61	2.26	3.23	-	5.1	10.0	12.0	1210	2830	4030	12.9	12.3	11.8
		20+25+35+35+35	1.33	1.67	2.33	2.33	2.33	-	5.1	10.0	12.0	1210	2840	4030	12.9	12.4	11.8
		20+35+35+35+35	1.25	2.19	2.19	2.19	2.19	-	5.1	10.0	12.0	1210	2830	4030	12.9	12.3	11.8
		25+25+25+25+25	2.00	2.00	2.00	2.00	2.00	-	5.1	10.0	12.0	1210	2850	4030	13.0	12.4	11.9
		25+25+25+25+35	1.85	1.85	1.85	1.85	2.59	-	5.1	10.0	12.0	1210	2840	4030	12.9	12.4	11.8
		25+25+25+25+50	1.67	1.67	1.67	1.67	3.33	-	5.1	10.0	12.0	1210	2840	4030	12.9	12.4	11.8
		25+25+25+25+60	1.56	1.56	1.56	1.56	3.75	-	5.1	10.0	12.0	1210	2830	4030	12.9	12.3	11.8
		25+25+25+35+35	1.72	1.72	1.72	2.41	2.41	-	5.1	10.0	12.0	1210	2840	4030	12.9	12.4	11.8
		25+25+25+35+50	1.56	1.56	1.56	2.19	3.13	-	5.1	10.0	12.0	1210	2830	4030	12.9	12.3	11.8
25+25+35+35+35	1.61	1.61	2.26	2.26	2.26	-	5.1	10.0	12.0	1210	2830	4030	12.9	12.3	11.8		

SCM100ZM-S Table of Indoor unit combination with other indoor unit

Indoor unit combination		Heating capacity (kW)									Power consumption(W)			Standard current(A)			
		Room heating capacity						Total capacity			Min.	Standard	Max.	220V	230V	240V	
		A	B	C	D	E	F	Min.	Standard	Max.							
Cooling operation	1 room	20	3.0	-	-	-	-	-	1.5	3.0	3.6	700	1220	1330	5.6	5.4	5.1
		25	3.4	-	-	-	-	-	1.5	3.4	4.1	700	1265	1540	5.8	5.6	5.3
		35	4.5	-	-	-	-	-	1.5	4.5	4.9	700	1650	1840	7.6	7.2	6.9
		50	5.8	-	-	-	-	-	1.5	5.8	6.4	700	2120	2410	9.7	9.3	8.9
		60	6.8	-	-	-	-	-	1.5	6.8	7.4	700	2500	2760	11.5	11.0	10.5
		71	8.0	-	-	-	-	-	1.5	8.0	8.1	700	3020	3090	13.9	13.3	12.7
		20+20	3.00	3.00	-	-	-	-	2.1	6.0	7.2	750	1540	1860	7.1	6.8	6.5
	20+25	2.84	3.56	-	-	-	-	2.1	6.4	7.7	750	1660	2210	7.6	7.3	7.0	
	20+35	2.73	4.77	-	-	-	-	2.1	7.5	8.5	750	1990	2520	9.1	8.7	8.4	
	20+50	2.51	6.29	-	-	-	-	2.1	8.8	10.0	750	2430	3220	11.2	10.7	10.2	
	20+60	2.45	7.35	-	-	-	-	2.1	9.8	11.0	750	2840	3620	13.0	12.5	12.0	
	20+71	2.42	8.58	-	-	-	-	2.1	11.0	11.6	750	2840	3620	13.0	12.5	12.0	
	25+25	3.40	3.40	-	-	-	-	2.1	6.8	8.2	750	1770	2420	8.1	7.8	7.4	
	25+35	3.29	4.61	-	-	-	-	2.1	7.9	9.0	750	2140	2820	9.8	9.4	9.0	
	25+50	3.07	6.13	-	-	-	-	2.1	9.2	10.5	750	2630	3610	12.1	11.6	11.1	
	25+60	3.00	7.20	-	-	-	-	2.1	10.2	11.5	750	3040	3790	14.0	13.4	12.8	
	25+71	2.97	8.43	-	-	-	-	2.1	11.4	12.1	750	3440	4250	15.8	15.1	14.5	
	35+35	4.50	4.50	-	-	-	-	2.1	9.0	9.8	750	2520	3210	11.6	11.1	10.6	
	35+50	4.24	6.06	-	-	-	-	2.1	10.3	11.3	750	3040	3710	14.0	13.4	12.8	
	35+60	4.16	7.14	-	-	-	-	2.1	11.3	12.3	750	3420	4320	15.7	15.0	14.4	
	35+71	3.96	8.04	-	-	-	-	2.1	12.0	12.9	750	4030	4690	18.5	17.7	17.0	
50+50	5.80	5.80	-	-	-	-	2.1	11.6	12.8	750	3660	4620	16.8	16.1	15.4		
50+60	5.45	6.55	-	-	-	-	2.1	12.0	13.3	750	4030	4920	18.5	17.7	17.0		
50+71	4.96	7.04	-	-	-	-	2.1	12.0	13.3	750	4030	4920	18.5	17.7	17.0		
60+60	6.00	6.00	-	-	-	-	2.1	12.0	13.3	750	4030	4920	18.5	17.7	17.0		
60+71	5.50	6.50	-	-	-	-	2.1	12.0	13.3	750	4030	4920	18.5	17.7	17.0		
71+71	6.00	6.00	-	-	-	-	2.1	12.0	13.3	750	4030	4920	18.5	17.7	17.0		
Heating operation	2 room	20+20+20	3.00	3.00	3.00	-	-	-	3.2	9.0	10.9	780	2270	3350	10.4	10.0	9.6
		20+20+25	2.89	2.89	3.62	-	-	-	3.2	9.4	11.4	780	2400	3550	11.0	10.5	10.1
		20+20+35	2.80	2.80	4.90	-	-	-	3.2	10.5	12.2	780	2760	3820	12.7	12.1	11.6
		20+20+50	2.62	2.62	6.56	-	-	-	3.2	11.8	13.3	780	3270	4290	15.0	14.4	13.8
		20+20+60	2.40	2.40	7.20	-	-	-	3.2	12.0	13.3	780	3420	4290	15.7	15.0	14.4
		20+20+71	2.16	2.16	7.68	-	-	-	3.2	12.0	13.3	780	3410	4290	15.7	15.0	14.4
		20+25+25	2.80	3.50	3.50	-	-	-	3.2	9.8	11.9	780	2560	3720	11.8	11.2	10.8
		20+25+35	2.73	3.41	4.77	-	-	-	3.2	10.9	12.7	780	2970	3990	13.6	13.0	12.5
		20+25+50	2.53	3.16	6.32	-	-	-	3.2	12.0	13.3	780	3420	4290	15.7	15.0	14.4
		20+25+60	2.29	2.86	6.86	-	-	-	3.2	12.0	13.3	780	3420	4290	15.7	15.0	14.4
		20+25+71	2.07	2.59	7.34	-	-	-	3.2	12.0	13.3	780	3410	4290	15.7	15.0	14.4
		20+35+35	2.67	4.67	4.67	-	-	-	3.2	12.0	13.3	780	3420	4290	15.7	15.0	14.4
	20+35+50	2.29	4.00	5.71	-	-	-	3.2	12.0	13.3	780	3420	4290	15.7	15.0	14.4	
	20+35+60	2.09	3.65	6.26	-	-	-	3.2	12.0	13.3	780	3410	4290	15.7	15.0	14.4	
	20+35+71	1.90	3.33	6.76	-	-	-	3.2	12.0	13.3	780	3410	4290	15.7	15.0	14.4	
	20+50+50	2.00	5.00	5.00	-	-	-	3.2	12.0	13.3	780	3410	4290	15.7	15.0	14.4	
	20+50+60	1.85	4.62	5.54	-	-	-	3.2	12.0	13.3	780	3400	4290	15.6	14.9	14.3	
	20+50+71	1.70	4.26	6.04	-	-	-	4.2	12.0	13.3	780	3390	4290	15.6	14.9	14.3	
	20+60+60	1.71	5.14	5.14	-	-	-	5.2	12.0	13.3	780	3390	4290	15.6	14.9	14.3	
	20+60+71	1.59	4.77	5.64	-	-	-	6.2	12.0	13.3	780	3390	4290	15.6	14.9	14.3	
	25+25+25	3.40	3.40	3.40	-	-	-	3.2	10.2	12.4	780	2760	3880	12.7	12.1	11.6	
	25+25+35	3.32	3.32	4.65	-	-	-	3.2	11.3	13.2	780	3170	4120	14.6	13.9	13.3	
	25+25+50	3.00	3.00	6.00	-	-	-	3.2	12.0	13.3	780	3420	4290	15.7	15.0	14.4	
	25+25+60	2.73	2.73	6.55	-	-	-	3.2	12.0	13.3	780	3410	4290	15.7	15.0	14.4	
	25+25+71	2.48	2.48	7.04	-	-	-	3.2	12.0	13.3	780	3410	4290	15.7	15.0	14.4	
	25+35+35	3.16	4.42	4.42	-	-	-	3.2	12.0	13.3	780	3420	4290	15.7	15.0	14.4	
	25+35+50	2.73	3.82	5.45	-	-	-	3.2	12.0	13.3	780	3410	4290	15.7	15.0	14.4	
	25+35+60	2.50	3.50	6.00	-	-	-	3.2	12.0	13.3	780	3410	4290	15.7	15.0	14.4	
	25+35+71	2.29	3.21	6.50	-	-	-	4.2	12.0	13.3	780	3400	4290	15.6	14.9	14.3	
	25+50+50	2.40	4.80	4.80	-	-	-	3.2	12.0	13.3	780	3410	4290	15.7	15.0	14.4	
25+50+60	2.22	4.44	5.33	-	-	-	3.2	12.0	13.3	780	3400	4290	15.6	14.9	14.3		

COMBINATIONS

Indoor unit combination		Heating capacity (kW)									Power consumption(W)			Standard current(A)		
		Room heating capacity						Total capacity			Min.	Standard	Max.	220V	230V	240V
		A	B	C	D	E	F	Min.	Standard	Max.						
3 room	25+50+71	2.05	4.11	5.84	-	-	-	3.2	12.0	13.3	780	3390	4290	15.6	14.9	14.3
	25+60+60	2.07	4.97	4.97	-	-	-	3.2	12.0	13.3	780	3390	4290	15.6	14.9	14.3
	25+60+71	1.92	4.62	5.46	-	-	-	3.2	12.0	13.3	780	3390	4290	15.6	14.9	14.3
	35+35+35	4.00	4.00	4.00	-	-	-	3.2	12.0	13.3	780	3420	4290	15.7	15.0	14.4
	35+35+50	3.50	3.50	5.00	-	-	-	3.2	12.0	13.3	780	3410	4290	15.7	15.0	14.4
	35+35+60	3.23	3.23	5.54	-	-	-	3.2	12.0	13.3	780	3400	4290	15.6	14.9	14.3
	35+35+71	2.98	2.98	6.04	-	-	-	3.2	12.0	13.3	780	3390	4290	15.6	14.9	14.3
	35+50+50	3.11	4.44	4.44	-	-	-	3.2	12.0	13.3	780	3400	4290	15.6	14.9	14.3
	35+50+60	2.90	4.14	4.97	-	-	-	3.2	12.0	13.3	780	3390	4290	15.6	14.9	14.3
	35+50+71	2.69	3.85	5.46	-	-	-	3.2	12.0	13.3	780	3390	4290	15.6	14.9	14.3
35+60+60	2.71	4.65	4.65	-	-	-	3.2	12.0	13.3	780	3390	4290	15.6	14.9	14.3	
50+50+50	4.00	4.00	4.00	-	-	-	3.2	12.0	13.3	780	3390	4290	15.6	14.9	14.3	
50+50+60	3.75	3.75	4.50	-	-	-	3.2	12.0	13.3	780	3380	4290	15.5	14.8	14.2	
4 room	20+20+20+20	3.00	3.00	3.00	3.00	-	-	3.6	12.0	13.3	950	3270	3920	14.9	14.2	13.6
	20+20+20+25	2.82	2.82	2.82	3.53	-	-	3.6	12.0	13.3	950	3270	3920	14.9	14.2	13.6
	20+20+20+35	2.53	2.53	2.53	4.42	-	-	3.6	12.0	13.3	950	3270	3920	14.9	14.2	13.6
	20+20+20+50	2.18	2.18	2.18	5.45	-	-	3.6	12.0	13.3	950	3260	3920	14.8	14.2	13.6
	20+20+20+60	2.00	2.00	2.00	6.00	-	-	3.6	12.0	13.3	950	3250	3920	14.8	14.1	13.6
	20+20+20+71	1.83	1.83	1.83	6.50	-	-	3.6	12.0	13.3	950	3250	3920	14.6	14.0	13.4
	20+20+25+25	2.67	2.67	3.33	3.33	-	-	3.6	12.0	13.3	950	3270	3920	14.9	14.2	13.6
	20+20+25+35	2.40	2.40	3.00	4.20	-	-	3.6	12.0	13.3	950	3260	3920	14.8	14.2	13.6
	20+20+25+50	2.09	2.09	2.61	5.22	-	-	3.6	12.0	13.3	950	3260	3920	14.8	14.2	13.6
	20+20+25+60	1.92	1.92	2.40	5.76	-	-	3.6	12.0	13.3	950	3250	3920	14.8	14.1	13.6
	20+20+25+71	1.76	1.76	2.21	6.26	-	-	3.6	12.0	13.3	950	3250	3920	14.8	14.1	13.6
	20+20+35+35	2.18	2.18	3.82	3.82	-	-	3.6	12.0	13.3	950	3260	3920	14.8	14.2	13.6
	20+20+35+50	1.92	1.92	3.36	4.80	-	-	3.6	12.0	13.3	950	3250	3920	14.8	14.1	13.6
	20+20+35+60	1.78	1.78	3.11	5.33	-	-	3.6	12.0	13.3	950	3250	3920	14.8	14.1	13.6
	20+20+35+71	1.64	1.64	2.88	5.84	-	-	3.6	12.0	13.3	950	3240	3920	14.7	14.1	13.5
	20+20+50+50	1.71	1.71	4.29	4.29	-	-	3.6	12.0	13.3	950	3240	3920	14.7	14.1	13.5
	20+20+50+60	1.60	1.60	4.00	4.80	-	-	3.6	12.0	13.3	950	3240	3920	14.7	14.1	13.5
	20+20+60+60	1.50	1.50	4.50	4.50	-	-	3.6	12.0	13.3	950	3240	3920	14.7	14.1	13.5
	20+25+25+25	2.53	3.16	3.16	3.16	-	-	3.6	12.0	13.3	950	3270	3920	14.9	14.2	13.6
	20+25+25+35	2.29	2.86	2.86	4.00	-	-	3.6	12.0	13.3	950	3260	3920	14.8	14.2	13.6
	20+25+25+50	2.00	2.50	2.50	5.00	-	-	3.6	12.0	13.3	950	3250	3920	14.8	14.1	13.6
	20+25+25+60	1.85	2.31	2.31	5.54	-	-	3.6	12.0	13.3	950	3250	3920	14.8	14.1	13.6
	20+25+25+71	1.70	2.13	2.13	6.04	-	-	3.6	12.0	13.3	950	3240	3920	14.7	14.1	13.5
	20+25+35+35	2.09	2.61	3.65	3.65	-	-	3.6	12.0	13.3	950	3260	3920	14.8	14.2	13.6
	20+25+35+50	1.85	2.31	3.23	4.62	-	-	3.6	12.0	13.3	950	3250	3920	14.8	14.1	13.6
	20+25+35+60	1.71	2.14	3.00	5.14	-	-	3.6	12.0	13.3	950	3240	3920	14.7	14.1	13.5
	20+25+35+71	1.59	1.99	2.78	5.64	-	-	3.6	12.0	13.3	950	3240	3920	14.7	14.1	13.5
	20+25+50+50	1.66	2.07	4.14	4.14	-	-	3.6	12.0	13.3	950	3240	3920	14.7	14.1	13.5
	20+25+50+60	1.55	1.94	3.87	4.65	-	-	3.6	12.0	13.3	950	3240	3920	14.7	14.1	13.5
	20+35+35+35	1.92	3.36	3.36	3.36	-	-	3.6	12.0	13.3	950	3250	3920	14.8	14.1	13.6
	20+35+35+50	1.71	3.00	3.00	4.29	-	-	3.6	12.0	13.3	950	3240	3920	14.7	14.1	13.5
	20+35+35+60	1.60	2.80	2.80	4.80	-	-	3.6	12.0	13.3	950	3240	3920	14.7	14.1	13.5
	20+35+50+50	1.55	2.71	3.87	3.87	-	-	3.6	12.0	13.3	950	3240	3920	14.7	14.1	13.5
	25+25+25+25	3.00	3.00	3.00	3.00	-	-	3.6	12.0	13.3	950	3260	3920	14.8	14.2	13.6
	25+25+25+35	2.73	2.73	2.73	3.82	-	-	3.6	12.0	13.3	950	3260	3920	14.8	14.2	13.6
	25+25+25+50	2.40	2.40	2.40	4.80	-	-	3.6	12.0	13.3	950	3250	3920	14.8	14.1	13.6
	25+25+25+60	2.22	2.22	2.22	5.33	-	-	3.6	12.0	13.3	950	3250	3920	14.8	14.1	13.6
	25+25+25+71	2.05	2.05	2.05	5.84	-	-	3.6	12.0	13.3	950	3240	3920	14.7	14.1	13.5
	25+25+35+35	2.50	2.50	3.50	3.50	-	-	3.6	12.0	13.3	950	3250	3920	14.8	14.1	13.6
	25+25+35+50	2.22	2.22	3.11	4.44	-	-	3.6	12.0	13.3	950	3250	3920	14.8	14.1	13.6
25+25+35+60	2.07	2.07	2.90	4.97	-	-	3.6	12.0	13.3	950	3240	3920	14.7	14.1	13.5	
25+25+35+71	1.92	1.92	2.69	5.46	-	-	3.6	12.0	13.3	950	3240	3920	14.7	14.1	13.5	
25+25+50+50	2.00	2.00	4.00	4.00	-	-	3.6	12.0	13.3	950	3240	3920	14.7	14.1	13.5	
25+25+50+60	1.88	1.88	3.75	4.50	-	-	3.6	12.0	13.3	950	3240	3920	14.7	14.1	13.5	
25+35+35+35	2.31	3.23	3.23	3.23	-	-	3.6	12.0	13.3	950	3250	3920	14.8	14.1	13.6	
25+35+35+50	2.07	2.90	2.90	4.14	-	-	3.6	12.0	13.3	950	3240	3920	14.7	14.1	13.5	
25+35+35+60	1.94	2.71	2.71	4.65	-	-	3.6	12.0	13.3	950	3240	3920	14.7	14.1	13.5	
25+35+50+50	1.88	2.63	3.75	3.75	-	-	3.6	12.0	13.3	950	3240	3920	14.7	14.1	13.5	
35+35+35+35	3.00	3.00	3.00	3.00	-	-	3.6	12.0	13.3	950	3240	3920	14.7	14.1	13.5	
35+35+35+50	2.71	2.71	2.71	3.87	-	-	3.6	12.0	13.3	950	3240	3920	14.7	14.1	13.5	
5 room	20+20+20+20+20	2.40	2.40	2.40	2.40	2.40	-	4.0	12.0	13.3	1050	3220	3620	14.7	14.0	13.4
	20+20+20+20+25	2.29	2.29	2.29	2.29	2.86	-	4.0	12.0	13.3	1050	3220	3620	14.7	14.0	13.4
	20+20+20+20+35	2.09	2.09	2.09	2.09	3.65	-	4.0	12.0	13.3	1050	3210	3620	14.6	14.0	13.4
	20+20+20+20+50	1.85	1.85	1.85	1.85	4.62	-	4.0	12.0	13.3	1050	3200	3620	14.6	13.9	13.3
	20+20+20+20+60	1.71	1.71	1.71	1.71	5.14	-	4.0	12.0	13.3	1050	3200	3620	14.6	13.9	13.3
	20+20+20+20+71	1.59	1.59	1.59	1.59	5.64	-	4.0	12.0	13.3	1050	3190	3620	14.5	13.9	13.3
	20+20+20+25+25	2.18	2.18	2.18	2.73	2.73	-	4.0	12.0	13.3	1050	3210	3620	14.6	14.0	13.4
	20+20+20+25+35	2.00	2.00	2.00	2.50	3.50	-	4.0	12.0	13.3	1050	3210	3620	14.6	14.0	13.4
	20+20+20+25+50	1.78	1.78	1.78	2.22	4.44	-	4.0	12.0	13.3	1050	3200	3620	14.6	13.9	13.3
	20+20+20+25+60	1.66	1.66	1.66	2.07	4.97	-	4.0	12.0	13.3	1050	3200	3620	14.6	13.9	13.3
20+20+20+25+71	1.54	1.54	1.54	1.92	5.46											



MULTI-SPLIT SYSTEM

Indoor unit combination		Heating capacity (kW)									Power consumption(W)			Standard current(A)			
		Room heating capacity						Total capacity			Min.	Standard	Max.	220V	230V	240V	
		A	B	C	D	E	F	Min.	Standard	Max.							
Heating operation	5 room	20+20+20+50+50	1.50	1.50	1.50	3.75	3.75	-	4.0	12.0	13.3	1050	3190	3620	14.5	13.9	13.3
		20+20+25+25+25	2.09	2.09	2.61	2.61	2.61	-	4.0	12.0	13.3	1050	3210	3620	14.6	14.0	13.4
		20+20+25+25+35	1.92	1.92	2.40	2.40	3.36	-	4.0	12.0	13.3	1050	3210	3620	14.6	14.0	13.4
		20+20+25+25+50	1.71	1.71	2.14	2.14	4.29	-	4.0	12.0	13.3	1050	3200	3620	14.6	13.9	13.3
		20+20+25+25+60	1.60	1.60	2.00	2.00	4.80	-	4.0	12.0	13.3	1050	3190	3620	14.5	13.9	13.3
		20+20+25+35+35	1.78	1.78	2.22	3.11	3.11	-	4.0	12.0	13.3	1050	3200	3620	14.6	13.9	13.3
		20+20+25+35+50	1.60	1.60	2.00	2.80	4.00	-	4.0	12.0	13.3	1050	3190	3620	14.5	13.9	13.3
		20+20+25+35+60	1.50	1.50	1.88	2.63	4.50	-	4.0	12.0	13.3	1050	3190	3620	14.5	13.9	13.3
		20+20+35+35+35	1.66	1.66	2.90	2.90	2.90	-	4.0	12.0	13.3	1050	3200	3620	14.6	13.9	13.3
		20+20+35+35+50	1.50	1.50	2.63	2.63	3.75	-	4.0	12.0	13.3	1050	3190	3620	14.5	13.9	13.3
		20+25+25+25+25	2.00	2.50	2.50	2.50	2.50	-	4.0	12.0	13.3	1050	3210	3620	14.6	14.0	13.4
		20+25+25+25+35	1.85	2.31	2.31	2.31	3.23	-	4.0	12.0	13.3	1050	3200	3620	14.6	13.9	13.3
		20+25+25+25+50	1.66	2.07	2.07	2.07	4.14	-	4.0	12.0	13.3	1050	3200	3620	14.6	13.9	13.3
		20+25+25+25+60	1.55	1.94	1.94	1.94	4.65	-	4.0	12.0	13.3	1050	3190	3620	14.5	13.9	13.3
		20+25+25+35+35	1.71	2.14	2.14	3.00	3.00	-	4.0	12.0	13.3	1050	3200	3620	14.6	13.9	13.3
		20+25+25+35+50	1.55	1.94	1.94	2.71	3.87	-	4.0	12.0	13.3	1050	3190	3620	14.5	13.9	13.3
		20+25+25+35+60	1.60	2.00	2.80	2.80	2.80	-	4.0	12.0	13.3	1050	3190	3620	14.5	13.9	13.3
		20+35+35+35+35	1.50	2.63	2.63	2.63	2.63	-	4.0	12.0	13.3	1050	3190	3620	14.5	13.9	13.3
		25+25+25+25+25	2.40	2.40	2.40	2.40	2.40	-	4.0	12.0	13.3	1050	3210	3620	14.6	14.0	13.4
		25+25+25+25+35	2.22	2.22	2.22	2.22	3.11	-	4.0	12.0	13.3	1050	3200	3620	14.6	13.9	13.3
25+25+25+25+50	2.00	2.00	2.00	2.00	4.00	-	4.0	12.0	13.3	1050	3190	3620	14.5	13.9	13.3		
25+25+25+25+60	1.88	1.88	1.88	1.88	4.50	-	4.0	12.0	13.3	1050	3190	3620	14.5	13.9	13.3		
25+25+25+35+35	2.07	2.07	2.07	2.90	2.90	-	4.0	12.0	13.3	1050	3200	3620	14.6	13.9	13.3		
25+25+25+35+50	1.88	1.88	1.88	2.63	3.75	-	4.0	12.0	13.3	1050	3190	3620	14.5	13.9	13.3		
25+25+35+35+35	1.94	1.94	2.71	2.71	2.71	-	4.0	12.0	13.3	1050	3190	3620	14.5	13.9	13.3		

Indoor unit combination		Cooling capacity (kW)									Power consumption(W)			Standard current(A)		
		Room cooling capacity						Total capacity			Min.	Standard	Max.	220V	230V	240V
		A	B	C	D	E	F	Min.	Standard	Max.						
Cooling operation	1 room	20	2.0	-	-	-	-	1.8	2.0	2.7	650	780	1100	3.6	3.4	3.3
		25	2.5	-	-	-	-	1.8	2.5	3.2	650	1000	1350	4.6	4.4	4.2
		35	3.5	-	-	-	-	1.8	3.5	3.7	650	1500	1600	6.9	6.6	6.3
		50	5.0	-	-	-	-	1.8	5.0	5.8	650	2150	2500	9.9	9.4	9.0
		60	6.0	-	-	-	-	1.8	6.0	6.7	650	2720	3000	12.5	11.9	11.4
		71	7.1	-	-	-	-	1.8	7.1	7.2	650	3250	3080	14.9	14.3	13.7
	2 room	20+20	2.00	2.00	-	-	-	3.0	4.0	5.4	740	960	1460	4.4	4.2	4.0
		20+25	2.00	2.50	-	-	-	3.0	4.5	5.9	740	1100	1820	5.1	4.8	4.6
		20+35	2.00	3.50	-	-	-	3.0	5.5	6.4	740	1500	2020	6.9	6.6	6.3
		20+50	2.00	5.00	-	-	-	3.0	7.0	8.5	740	2290	2820	10.5	10.1	9.6
		20+60	2.00	6.00	-	-	-	3.0	8.0	9.4	740	2660	3360	12.2	11.7	11.2
		20+71	2.00	7.10	-	-	-	3.0	9.1	9.9	740	3100	3780	14.1	13.5	12.9
		25+25	2.50	2.50	-	-	-	3.0	5.0	6.8	740	1420	2200	6.5	6.2	6.0
		25+35	2.50	3.50	-	-	-	3.0	6.0	6.9	740	1810	2320	8.3	7.9	7.6
		25+50	2.50	5.00	-	-	-	3.0	7.5	9.0	740	2470	3220	11.3	10.8	10.4
		25+60	2.50	6.00	-	-	-	3.0	8.5	9.4	740	2810	3360	12.9	12.3	11.8
		25+71	2.53	7.17	-	-	-	3.0	9.7	10.4	740	3350	4020	15.4	14.7	14.1
		35+35	3.50	3.50	-	-	-	3.0	7.0	7.4	740	2290	2820	10.5	10.1	9.6
		35+50	3.50	5.00	-	-	-	3.0	8.5	9.5	740	2810	3620	12.9	12.3	11.8
		35+60	3.50	6.00	-	-	-	3.0	9.5	10.4	740	3280	3990	15.1	14.4	13.8
35+71	3.30	6.70	-	-	-	3.0	10.0	10.9	740	3480	4250	15.8	15.1	14.5		
50+50	5.00	5.00	-	-	-	3.0	10.0	11.6	740	3480	4350	16.0	15.3	14.6		
50+60	4.55	5.45	-	-	-	3.0	10.0	11.8	740	3480	4410	16.0	15.3	14.6		
50+71	4.13	5.87	-	-	-	3.0	10.0	11.8	740	3470	4410	15.8	15.1	14.5		
60+60	5.00	5.00	-	-	-	3.0	10.0	11.8	740	3470	4410	15.9	15.2	14.6		
60+71	4.58	5.42	-	-	-	3.0	10.0	11.8	740	3470	4410	15.8	15.1	14.5		
71+71	5.00	5.00	-	-	-	3.0	10.0	11.8	740	3460	4410	15.6	14.9	14.3		
3 room	20+20+20	2.00	2.00	2.00	-	-	3.7	6.0	8.1	880	1530	2490	7.0	6.7	6.4	
	20+20+25	2.00	2.00	2.50	-	-	3.7	6.5	8.6	880	1730	2700	7.9	7.6	7.3	
	20+20+35	2.00	2.00	3.50	-	-	3.7	7.5	9.1	880	2080	3120	9.6	9.1	8.8	
	20+20+50	2.00	2.00	5.00	-	-	3.7	9.0	11.2	880	2730	4000	12.5	12.0	11.5	
	20+20+60	2.00	2.00	6.00	-	-	3.7	10.0	11.8	880	3280	4250	15.1	14.4	13.8	
	20+20+71	1.80	1.80	6.40	-	-	3.7	10.0	11.8	880	3280	4250	15.1	14.4	13.8	
	20+25+25	2.00	2.50	2.50	-	-	3.7	7.0	9.1	880	1940	3210	8.9	8.5	8.2	
	20+25+35	2.00	2.50	3.50	-	-	3.7	8.0	9.6	880	2440	3630	11.2	10.7	10.3	
	20+25+50	2.00	2.50	5.00	-	-	3.7	9.5	11.5	880	3130	4120	14.4	13.7	13.2	
	20+25+60	1.90	2.38	5.71	-	-	3.7	10.0	11.8	880	3280	4250	15.1	14.4	13.8	
	20+25+71	1.72	2.16	6.12	-	-	3.7	10.0	11.8	880	3280	4250	15.1	14.4	13.8	
	20+35+35	2.00	3.50	3.50	-	-	3.7	9.0	10.1	880	2920	3640	13.4	12.8	12.3	
	20+35+50	1.90	3.33	4.76	-	-	3.7	10.0	11.8	880	3280	4250	15.1	14.4	13.8	
	20+35+60	1.74	3.04	5.22	-	-	3.7	10.0	11.8	880	3280	4250	15.1	14.4	13.8	
	20+35+71	1.59	2.78	5.63	-	-	4.7	10.0	11.8	880	3270	4250	15.0	14.4	13.8	
	20+50+50	1.67	4.17	4.17	-	-	3.7	10.0	11.8	880	3270	4250	15.0	14.4	13.8	
	20+50+60	1.54	3.85	4.62	-	-	3.7	10.0	11.8	880	3270	4250	15.0	14.4	13.8	
	20+50+71	1.42	3.55	5.04	-	-	3.7	10.0	11.8	880	3260	4250	15.0	14.3	13.7	
	20+60+60	1.43	4.29	4.29	-	-	3.7	10.0	11.8	880	3260	4250	15.0	14.3	13.7	
20+60+71	1.32	3.97	4.70	-	-	3.7	10.0	11.8	880	3260	4250	15.0	14.3	13.7		
25+25+25	2.50	2.50	2.50	-	-	3.7	7.5	9.4	880	2130	3340	9.8	9.4	9.0		

COMBINATIONS

Indoor unit combination		Cooling capacity (kW)									Power consumption(W)			Standard current(A)		
		Room cooling capacity						Total capacity			Min.	Standard	Max.	220V	230V	240V
		A	B	C	D	E	F	Min.	Standard	Max.						
3 room	25+25+35	2.50	2.50	3.50	-	-	-	3.7	8.5	9.9	880	2650	3540	12.2	11.6	11.2
	25+25+50	2.50	2.50	5.00	-	-	-	3.7	10.0	11.8	880	3280	4250	15.1	14.4	13.8
	25+25+60	2.27	2.27	5.45	-	-	-	3.7	10.0	11.8	880	3280	4250	15.1	14.4	13.8
	25+25+71	2.07	2.07	5.87	-	-	-	3.7	10.0	11.8	880	3270	4250	15.0	14.4	13.8
	25+35+35	2.50	3.50	3.50	-	-	-	3.7	9.5	10.4	880	3130	3950	14.4	13.7	13.2
	25+35+50	2.27	3.18	4.55	-	-	-	3.7	10.0	11.8	880	3280	4250	15.1	14.4	13.8
	25+35+60	2.08	2.92	5.00	-	-	-	3.7	10.0	11.8	880	3270	4250	15.0	14.4	13.8
	25+35+71	1.91	2.67	5.42	-	-	-	3.7	10.0	11.8	880	3270	4250	15.0	14.4	13.8
	25+50+50	2.00	4.00	4.00	-	-	-	3.7	10.0	11.8	880	3270	4250	15.0	14.4	13.8
	25+50+60	1.85	3.70	4.44	-	-	-	3.7	10.0	11.8	880	3270	4250	15.0	14.4	13.8
	25+50+71	1.71	3.42	4.86	-	-	-	3.7	10.0	11.8	880	3260	4250	21.4	20.5	19.7
	25+60+60	1.72	4.14	4.14	-	-	-	3.7	10.0	11.8	880	3260	4250	21.4	20.5	19.7
	25+60+71	1.60	3.85	4.55	-	-	-	3.7	10.0	11.8	880	3260	4250	21.4	20.5	19.7
	35+35+35	3.33	3.33	3.33	-	-	-	3.7	10.0	10.9	880	3280	4120	15.1	14.4	13.8
	35+35+50	2.92	2.92	4.17	-	-	-	3.7	10.0	11.8	880	3270	4250	15.0	14.4	13.8
	35+35+60	2.69	2.69	4.62	-	-	-	3.7	10.0	11.8	880	3270	4250	15.0	14.4	13.8
	35+35+71	2.48	2.48	5.04	-	-	-	3.7	10.0	11.8	880	3260	4250	14.8	14.2	13.6
	35+50+50	2.59	3.70	3.70	-	-	-	3.7	10.0	11.8	880	3270	4250	15.0	14.4	13.8
	35+50+60	2.41	3.45	4.14	-	-	-	3.7	10.0	11.8	880	3260	4250	15.0	14.3	13.7
	35+50+71	2.24	3.21	4.55	-	-	-	3.7	10.0	11.8	880	3260	4250	15.0	14.3	13.7
35+60+60	2.26	3.87	3.87	-	-	-	3.7	10.0	11.8	880	3260	4250	15.0	14.3	13.7	
50+50+50	3.33	3.33	3.33	-	-	-	3.7	10.0	11.8	880	3260	4250	15.0	14.3	13.7	
50+50+60	3.13	3.13	3.75	-	-	-	3.7	10.0	11.8	880	3260	4250	15.0	14.3	13.7	
Cooling operation	20+20+20+20	2.00	2.00	2.00	2.00	-	-	4.4	8.0	10.8	1100	2110	3680	9.6	9.2	8.8
	20+20+20+25	2.00	2.00	2.00	2.50	-	-	4.4	8.5	11.1	1100	2390	3890	10.9	10.4	10.0
	20+20+20+35	2.00	2.00	2.00	3.50	-	-	4.4	9.5	11.6	1100	2900	3990	13.2	12.6	12.1
	20+20+20+50	1.82	1.82	1.82	4.55	-	-	4.4	10.0	11.8	1100	3210	4050	14.6	14.0	13.4
	20+20+20+60	1.67	1.67	1.67	5.00	-	-	4.4	10.0	11.8	1100	3210	4050	14.6	14.0	13.4
	20+20+20+71	1.53	1.53	1.53	5.42	-	-	4.4	10.0	11.8	1100	3200	4050	14.4	13.8	13.2
	20+20+25+25	2.00	2.00	2.50	2.50	-	-	4.4	9.0	11.6	1100	2600	3990	11.8	11.3	10.8
	20+20+25+35	2.00	2.00	2.50	3.50	-	-	4.4	10.0	11.8	1100	3220	4050	14.7	14.0	13.4
	20+20+25+50	1.74	1.74	2.17	4.35	-	-	4.4	10.0	11.8	1100	3210	4050	14.6	14.0	13.4
	20+20+25+60	1.60	1.60	2.00	4.80	-	-	4.4	10.0	11.8	1100	3210	4050	14.6	14.0	13.4
	20+20+25+71	1.47	1.47	1.84	5.22	-	-	4.4	10.0	11.8	1100	3200	4050	14.6	13.9	13.3
	20+20+35+35	1.82	1.82	3.18	3.18	-	-	4.4	10.0	11.8	1100	3210	4050	14.6	14.0	13.4
	20+20+35+50	1.60	1.60	2.80	4.00	-	-	4.4	10.0	11.8	1100	3210	4050	14.6	14.0	13.4
	20+20+35+60	1.48	1.48	2.59	4.44	-	-	4.4	10.0	11.8	1100	3200	4050	14.6	13.9	13.3
	20+20+35+71	1.37	1.37	2.40	4.86	-	-	4.4	10.0	11.8	1100	3190	4050	14.5	13.9	13.3
	20+20+50+50	1.43	1.43	3.57	3.57	-	-	4.4	10.0	11.8	1100	3190	4050	14.5	13.9	13.3
	20+20+50+60	1.33	1.33	3.33	4.00	-	-	4.4	10.0	11.8	1100	3190	4050	14.5	13.9	13.3
	20+20+60+60	1.25	1.25	3.75	3.75	-	-	4.4	10.0	11.8	1100	3180	4050	14.5	13.8	13.3
	20+25+25+25	2.00	2.50	2.50	2.50	-	-	4.4	9.5	11.8	1100	2900	4050	13.2	12.6	12.1
	20+25+25+35	1.90	2.38	2.38	3.33	-	-	4.4	10.0	11.8	1100	3220	4050	14.7	14.0	13.4
	20+25+25+50	1.67	2.08	2.08	4.17	-	-	4.4	10.0	11.8	1100	3210	4050	14.6	14.0	13.4
	20+25+25+60	1.54	1.92	1.92	4.62	-	-	4.4	10.0	11.8	1100	3200	4050	14.6	13.9	13.3
	21+26+26+71	1.46	1.81	1.81	4.93	-	-	4.4	10.0	11.8	1100	3190	4050	14.5	13.9	13.3
	20+25+35+35	1.74	2.17	3.04	3.04	-	-	4.4	10.0	11.8	1100	3210	4050	14.6	14.0	13.4
	20+25+35+50	1.54	1.92	2.69	3.85	-	-	4.4	10.0	11.8	1100	3200	4050	14.6	13.9	13.3
	20+25+35+60	1.43	1.79	2.50	4.29	-	-	4.4	10.0	11.8	1100	3190	4050	14.5	13.9	13.3
	20+25+35+71	1.32	1.66	2.32	4.70	-	-	4.4	10.0	11.8	1100	3190	4050	14.5	13.9	13.3
	20+25+50+50	1.38	1.72	3.45	3.45	-	-	4.4	10.0	11.8	1100	3190	4050	14.5	13.9	13.3
	20+25+50+60	1.29	1.61	3.23	3.87	-	-	4.4	10.0	11.8	1100	3190	4050	14.5	13.9	13.3
	20+35+35+35	1.60	2.80	2.80	2.80	-	-	4.4	10.0	11.8	1100	3210	4050	14.6	14.0	13.4
	20+35+35+50	1.43	2.50	2.50	3.57	-	-	4.4	10.0	11.8	1100	3190	4050	14.5	13.9	13.3
	20+35+35+60	1.33	2.33	2.33	4.00	-	-	4.4	10.0	11.8	1100	3190	4050	14.5	13.9	13.3
	20+35+50+50	1.29	2.26	3.23	3.23	-	-	4.4	10.0	11.8	1100	3190	4050	14.5	13.9	13.3
	25+25+25+25	2.50	2.50	2.50	2.50	-	-	4.4	10.0	11.8	1100	3220	4050	14.7	14.0	13.4
	25+25+25+35	2.27	2.27	2.27	3.18	-	-	4.4	10.0	11.8	1100	3210	4050	14.6	14.0	13.4
	25+25+25+50	2.00	2.00	2.00	4.00	-	-	4.4	10.0	11.8	1100	3210	4050	14.6	14.0	13.4
	25+25+25+60	1.85	1.85	1.85	4.44	-	-	4.4	10.0	11.8	1100	3200	4050	14.6	13.9	13.3
	25+25+25+71	1.71	1.71	1.71	4.86	-	-	4.4	10.0	11.8	1100	3190	4050	14.5	13.9	13.3
	25+25+35+35	2.08	2.08	2.92	2.92	-	-	4.4	10.0	11.8	1100	3210	4050	14.6	14.0	13.4
	25+25+35+50	1.85	1.85	2.59	3.70	-	-	4.4	10.0	11.8	1100	3200	4050	14.6	13.9	13.3
25+25+35+60	1.72	1.72	2.41	4.14	-	-	4.4	10.0	11.8	1100	3190	4050	14.5	13.9	13.3	
25+25+35+71	1.60	1.60	2.24	4.55	-	-	4.4	10.0	11.8	1100	3190	4050	14.5	13.9	13.3	
25+25+50+50	1.67	1.67	3.33	3.33	-	-	4.4	10.0	11.8	1100	3190	4050	14.5	13.9	13.3	
25+25+50+60	1.56	1.56	3.13	3.75	-	-	4.4	10.0	11.8	1100	3180	4050	14.5	13.8	13.3	
25+35+35+35	1.92	2.69	2.69	2.69	-	-	4.4	10.0	11.8	1100	3200	4050	14.6	13.9	13.3	
25+35+35+50	1.72	2.41	2.41	3.45	-	-	4.4	10.0	11.8	1100	3190	4050	14.5	13.9	13.3	
25+35+35+60	1.61	2.26	2.26	3.87	-	-	4.4	10.0	11.8	1100	3190	4050	14.5	13.9	13.3	
25+35+50+50	1.56	2.19	3.13	3.13	-	-	4.4	10.0	11.8	1100	3180	4050	14.5	13.8	13.3	
35+35+35+35	2.50	2.50	2.50	2.50	-	-	4.4	10.0	11.8	1100	3190	4050	14.5	13.9	13.3	
35+35+35+50	2.26	2.26	2.26	3.23	-	-	4.4	10.0	11.8	1100	3190	4050	14.5	13.9	13.3	
5 room	20+20+20+20+20	2.00	2.00	2.00	2.00	2.00	-	5.1	10.0	11.8	1210	2950	4030	13.4	12.8	12.3
	20+20+2															



MULTI-SPLIT SYSTEM

Indoor unit combination		Cooling capacity (kW)									Power consumption(W)			Standard current(A)			
		Room cooling capacity						Total capacity			Min.	Standard	Max.	220V	230V	240V	
		A	B	C	D	E	F	Min.	Standard	Max.							
Cooling operation	5 room	20+20+20+20+60	1.43	1.43	1.43	1.43	4.29	-	5.1	10.0	11.8	1210	2930	4030	13.3	12.8	12.2
		20+20+20+20+71	1.32	1.32	1.32	1.32	4.70	-	5.1	10.0	11.8	1210	2930	4030	13.3	12.8	12.2
		20+20+20+25+25	1.82	1.82	1.82	2.27	2.27	-	5.1	10.0	11.8	1210	2950	4030	13.4	12.8	12.3
		20+20+20+25+35	1.67	1.67	1.67	2.08	2.92	-	5.1	10.0	11.8	1210	2940	4030	13.4	12.8	12.3
		20+20+20+25+50	1.48	1.48	1.48	1.85	3.70	-	5.1	10.0	11.8	1210	2940	4030	13.4	12.8	12.3
		20+20+20+25+60	1.38	1.38	1.38	1.72	4.14	-	5.1	10.0	11.8	1210	2930	4030	13.3	12.8	12.2
		20+20+20+25+71	1.28	1.28	1.28	1.60	4.55	-	5.1	10.0	11.8	1210	2930	4030	13.3	12.8	12.2
		20+20+20+35+35	1.54	1.54	1.54	2.69	2.69	-	5.1	10.0	11.8	1210	2940	4030	13.4	12.8	12.3
		20+20+20+35+50	1.38	1.38	1.38	2.41	3.45	-	5.1	10.0	11.8	1210	2930	4030	13.3	12.8	12.2
		20+20+20+35+60	1.29	1.29	1.29	2.26	3.87	-	5.1	10.0	11.8	1210	2930	4030	13.3	12.8	12.2
		20+20+20+50+50	1.25	1.25	1.25	3.13	3.13	-	5.1	10.0	11.8	1210	2930	4030	13.3	12.8	12.2
		20+20+25+25+25	1.74	1.74	2.17	2.17	2.17	-	5.1	10.0	11.8	1210	2950	4030	13.4	12.8	12.3
		20+20+25+25+35	1.60	1.60	2.00	2.00	2.80	-	5.1	10.0	11.8	1210	2940	4030	13.4	12.8	12.3
		20+20+25+25+50	1.43	1.43	1.79	1.79	3.57	-	5.1	10.0	11.8	1210	2930	4030	13.3	12.8	12.2
		20+20+25+25+60	1.33	1.33	1.67	1.67	4.00	-	5.1	10.0	11.8	1210	2930	4030	13.3	12.8	12.2
		20+20+25+35+35	1.48	1.48	1.85	2.59	2.59	-	5.1	10.0	11.8	1210	2940	4030	13.4	12.8	12.3
		20+20+25+35+50	1.33	1.33	1.67	2.33	3.33	-	5.1	10.0	11.8	1210	2930	4030	13.3	12.8	12.2
		20+20+25+35+60	1.25	1.25	1.56	2.19	3.75	-	5.1	10.0	11.8	1210	2930	4030	13.3	12.8	12.2
		20+20+35+35+35	1.38	1.38	2.41	2.41	2.41	-	5.1	10.0	11.8	1210	2930	4030	13.3	12.8	12.2
		20+20+35+35+50	1.25	1.25	2.19	2.19	3.13	-	5.1	10.0	11.8	1210	2930	4030	13.3	12.8	12.2
		20+25+25+25+25	1.67	2.08	2.08	2.08	2.08	-	5.1	10.0	11.8	1210	2940	4030	13.4	12.8	12.3
		20+25+25+25+35	1.54	1.92	1.92	1.92	2.69	-	5.1	10.0	11.8	1210	2940	4030	13.4	12.8	12.3
		20+25+25+25+50	1.38	1.72	1.72	1.72	3.45	-	5.1	10.0	11.8	1210	2930	4030	13.3	12.8	12.2
		20+25+25+25+60	1.29	1.61	1.61	1.61	3.87	-	5.1	10.0	11.8	1210	2930	4030	13.3	12.8	12.2
		20+25+25+35+35	1.43	1.79	1.79	2.50	2.50	-	5.1	10.0	11.8	1210	2930	4030	13.3	12.8	12.2
		20+25+25+35+50	1.29	1.61	1.61	2.26	3.23	-	5.1	10.0	11.8	1210	2930	4030	13.3	12.8	12.2
		20+25+35+35+35	1.33	1.67	2.33	2.33	2.33	-	5.1	10.0	11.8	1210	2930	4030	13.3	12.8	12.2
		20+35+35+35+35	1.25	2.19	2.19	2.19	2.19	-	5.1	10.0	11.8	1210	2930	4030	13.3	12.8	12.2
		25+25+25+25+25	2.00	2.00	2.00	2.00	2.00	-	5.1	10.0	11.8	1210	2940	4030	13.4	12.8	12.3
		25+25+25+25+35	1.85	1.85	1.85	1.85	2.59	-	5.1	10.0	11.8	1210	2940	4030	13.4	12.8	12.3
25+25+25+25+50	1.67	1.67	1.67	1.67	3.33	-	5.1	10.0	11.8	1210	2930	4030	13.3	12.8	12.2		
25+25+25+25+60	1.56	1.56	1.56	1.56	3.75	-	5.1	10.0	11.8	1210	2930	4030	13.3	12.8	12.2		
25+25+25+35+35	1.72	1.72	1.72	2.41	2.41	-	5.1	10.0	11.8	1210	2930	4030	13.3	12.8	12.2		
25+25+25+35+50	1.56	1.56	1.56	2.19	3.13	-	5.1	10.0	11.8	1210	2930	4030	13.3	12.8	12.2		
25+25+35+35+35	1.61	1.61	2.26	2.26	2.26	-	5.1	10.0	11.8	1210	2930	4030	13.3	12.8	12.2		

SCM125ZM-S Table of Indoor unit combination only with SRK-ZSX type

Indoor unit combination		Heating capacity (kW)									Power consumption(W)			Standard current(A)			
		Room heating capacity						Total capacity			Min.	Standard	Max.	220V	230V	240V	
		A	B	C	D	E	F	Min.	Standard	Max.							
Heating operation	1 room	20	3.0	-	-	-	-	1.5	3.0	3.7	700	1010	1330	4.6	4.4	4.3	
		25	3.4	-	-	-	-	1.5	3.4	4.2	700	1150	1540	5.3	5.1	4.8	
		35	4.5	-	-	-	-	1.5	4.5	5.0	700	1540	1840	7.1	6.8	6.5	
		50	5.8	-	-	-	-	1.5	5.8	6.5	700	2000	2410	9.2	8.8	8.4	
		60	6.8	-	-	-	-	1.5	6.8	7.5	700	2360	2760	10.8	10.4	9.9	
	2 room	20+20	3.00	3.00	-	-	-	-	2.1	6.0	7.4	750	1510	1460	6.9	6.6	6.4
		20+25	2.84	3.56	-	-	-	-	2.1	6.4	7.9	750	1630	2210	7.5	7.2	6.9
		20+35	2.73	4.77	-	-	-	-	2.1	7.5	8.7	750	1950	2520	9.0	8.6	8.2
		20+50	2.51	6.29	-	-	-	-	2.1	8.8	10.2	750	2380	3220	10.9	10.5	10.0
		20+60	2.45	7.35	-	-	-	-	2.1	9.8	11.2	750	2780	3620	12.8	12.2	11.7
		25+25	3.40	3.40	-	-	-	-	2.1	6.8	8.4	750	1740	2420	8.0	7.6	7.3
		25+35	3.29	4.61	-	-	-	-	2.1	7.9	9.2	750	2100	2820	9.6	9.2	8.8
		25+50	3.07	6.13	-	-	-	-	2.1	9.2	10.7	750	2580	3610	11.8	11.3	10.9
		25+60	3.00	7.20	-	-	-	-	2.1	10.2	11.7	750	2980	3790	13.7	13.1	12.5
		35+35	4.50	4.50	-	-	-	-	2.1	9.0	10.0	750	2470	3210	11.3	10.8	10.4
		35+50	4.24	6.06	-	-	-	-	2.1	10.3	11.5	750	2980	3710	13.7	13.1	12.5
		35+60	4.16	7.14	-	-	-	-	2.1	11.3	12.5	750	3350	4320	15.4	14.7	14.1
		50+50	5.80	5.80	-	-	-	-	2.1	11.6	13.0	750	3590	4620	16.5	15.8	15.1
		50+60	5.73	6.87	-	-	-	-	2.1	12.6	14.0	750	4010	5230	18.4	17.6	16.9
		60+60	6.75	6.75	-	-	-	-	2.1	13.5	14.0	750	4450	5230	20.4	19.5	18.7
	3 room	20+20+20	3.00	3.00	3.00	-	-	-	3.2	9.0	11.1	780	2230	3350	10.2	9.8	9.4
		20+20+25	2.89	2.89	3.62	-	-	-	3.2	9.4	11.6	780	2350	3550	10.8	10.3	9.9
		20+20+35	2.80	2.80	4.90	-	-	-	3.2	10.5	12.4	780	2710	3820	12.4	11.9	11.4
		20+20+50	2.62	2.62	6.56	-	-	-	3.2	11.8	13.9	780	3210	4290	14.7	14.1	13.5
		20+20+60	2.56	2.56	7.68	-	-	-	3.2	12.8	14.0	780	3620	4350	16.6	15.9	15.2
		20+25+25	2.80	3.50	3.50	-	-	-	3.2	9.8	12.1	780	2510	3720	11.5	11.0	10.6
		20+25+35	2.73	3.41	4.77	-	-	-	3.2	10.9	12.9	780	2910	3990	13.4	12.8	12.2
		20+25+50	2.57	3.21	6.42	-	-	-	3.2	12.2	14.0	780	3410	4350	15.7	15.0	14.4
		20+25+60	2.51	3.14	7.54	-	-	-	3.2	13.2	14.0	780	3910	4350	18.0	17.2	16.5
		20+35+35	2.67	4.67	4.67	-	-	-	3.2	12.0	13.7	780	3390	4220	15.6	14.9	14.3
20+35+50		2.53	4.43	6.33	-	-	-	3.2	13.3	14.0	780	3900	4350	17.9	17.1	16.4	
20+35+60		2.35	4.11	7.04	-	-	-	3.2	13.5	14.0	780	4050	4350	18.6	17.8	17.0	
20+50+50		2.25	5.63	5.63	-	-	-	3.2	13.5	14.0	780	4050	4350	18.6	17.8	17.0	
20+50+60		2.08	5.19	6.23	-	-	-	3.2	13.5	14.0	780	4050	4350	18.6	17.8	17.0	
20+60+60		1.93	5.79	5.79	-	-	-	3.2	13.5	14.0	780	4050	4350	18.6	17.8	17.0	

COMBINATIONS

Indoor unit combination		Heating capacity (kW)									Power consumption(W)			Standard current(A)		
		Room heating capacity						Total capacity			Min.	Standard	Max.	220V	230V	240V
		A	B	C	D	E	F	Min.	Standard	Max.						
3 room	25+25+25	3.40	3.40	3.40	-	-	-	3.2	10.2	12.6	780	2710	3680	12.4	11.9	11.4
	25+25+35	3.32	3.32	4.65	-	-	-	3.2	11.3	13.4	780	3110	4120	14.3	13.7	13.1
	25+25+50	3.15	3.15	6.30	-	-	-	3.2	12.6	14.0	780	3620	4350	16.6	15.9	15.2
	25+25+60	3.07	3.07	7.36	-	-	-	3.2	13.5	14.0	780	4050	4350	18.6	17.8	17.0
	25+35+35	3.26	4.57	4.57	-	-	-	3.2	12.4	14.0	780	3710	4350	17.0	16.3	15.6
	25+35+50	3.07	4.30	6.14	-	-	-	3.2	13.5	14.0	780	4060	4350	18.6	17.8	17.1
	25+35+60	2.81	3.94	6.75	-	-	-	3.2	13.5	14.0	780	4060	4350	18.6	17.8	17.1
	25+50+50	2.70	5.40	5.40	-	-	-	3.2	13.5	14.0	780	4050	4350	18.6	17.8	17.0
	25+50+60	2.50	5.00	6.00	-	-	-	3.2	13.5	14.0	780	4050	4350	18.6	17.8	17.0
	25+60+60	2.33	5.59	5.59	-	-	-	3.2	13.5	14.0	780	4050	4350	18.6	17.8	17.0
	35+35+35	4.50	4.50	4.50	-	-	-	3.2	13.5	14.0	780	4060	4350	18.6	17.8	17.1
	35+35+50	3.94	3.94	5.63	-	-	-	3.2	13.5	14.0	780	4060	4350	18.6	17.8	17.1
	35+35+60	3.63	3.63	6.23	-	-	-	3.2	13.5	14.0	780	4050	4350	18.6	17.8	17.0
	35+50+50	3.50	5.00	5.00	-	-	-	3.2	13.5	14.0	780	4050	4350	18.6	17.8	17.0
	35+50+60	3.26	4.66	5.59	-	-	-	3.2	13.5	14.0	780	4050	4350	18.6	17.8	17.0
	35+60+60	3.05	5.23	5.23	-	-	-	3.2	13.5	14.0	780	4050	4350	18.6	17.8	17.0
	50+50+50	4.50	4.50	4.50	-	-	-	3.2	13.5	14.0	780	4040	4350	18.5	17.7	17.0
	50+50+60	4.22	4.22	5.06	-	-	-	3.2	13.5	14.0	780	4040	4350	18.5	17.7	17.0
	50+60+60	3.97	4.76	4.76	-	-	-	3.2	13.5	14.0	780	4040	4350	18.5	17.7	17.0
	60+60+60	4.50	4.50	4.50	-	-	-	3.2	13.5	14.0	780	4030	4350	18.5	17.7	17.0
4 room	20+20+20+20	3.00	3.00	3.00	3.00	-	-	3.6	12.0	14.0	950	3210	3920	14.6	14.0	13.4
	20+20+20+25	2.92	2.92	2.92	3.65	-	-	3.6	12.4	14.0	950	3390	3920	15.4	14.8	14.1
	20+20+20+35	2.84	2.84	2.84	4.97	-	-	3.6	13.5	14.0	950	3700	3920	16.8	16.1	15.4
	20+20+20+50	2.45	2.45	2.45	6.14	-	-	3.6	13.5	14.0	950	3690	3920	16.8	16.1	15.4
	20+20+20+60	2.25	2.25	2.25	6.75	-	-	3.6	13.5	14.0	950	3690	3920	16.8	16.1	15.4
	20+20+25+25	2.84	2.84	3.56	3.56	-	-	3.6	12.8	14.0	950	3440	3920	15.7	15.0	14.3
	20+20+25+35	2.70	2.70	3.38	4.73	-	-	3.6	13.5	14.0	950	3700	3920	16.8	16.1	15.4
	20+20+25+50	2.35	2.35	2.93	5.87	-	-	3.6	13.5	14.0	950	3690	3920	16.8	16.1	15.4
	20+20+25+60	2.16	2.16	2.70	6.48	-	-	3.6	13.5	14.0	950	3680	3920	16.7	16.0	15.3
	20+20+35+35	2.45	2.45	4.30	4.30	-	-	3.6	13.5	14.0	950	3690	3920	16.8	16.1	15.4
	20+20+35+50	2.16	2.16	3.78	5.40	-	-	3.6	13.5	14.0	950	3680	3920	16.7	16.0	15.3
	20+20+35+60	2.00	2.00	3.50	6.00	-	-	3.6	13.5	14.0	950	3680	3920	16.7	16.0	15.3
	20+20+50+50	1.93	1.93	4.82	4.82	-	-	3.6	13.5	14.0	950	3670	3920	16.7	16.0	15.3
	20+20+50+60	1.80	1.80	4.50	5.40	-	-	3.6	13.5	14.0	950	3670	3920	16.7	16.0	15.3
	20+20+60+60	1.69	1.69	5.06	5.06	-	-	3.6	13.5	14.0	950	3670	3920	16.7	16.0	15.3
	20+25+25+25	2.78	3.47	3.47	3.47	-	-	3.6	13.2	14.0	950	3550	3920	16.2	15.5	14.8
	20+25+25+35	2.57	3.21	3.21	4.50	-	-	3.6	13.5	14.0	950	3700	3920	16.8	16.1	15.4
	20+25+25+50	2.25	2.81	2.81	5.63	-	-	3.6	13.5	14.0	950	3690	3920	16.8	16.1	15.4
	20+25+25+60	2.08	2.60	2.60	6.23	-	-	3.6	13.5	14.0	950	3680	3920	16.7	16.0	15.3
	20+25+35+35	2.35	2.93	4.11	4.11	-	-	3.6	13.5	14.0	950	3690	3920	16.8	16.1	15.4
	20+25+35+50	2.08	2.60	3.63	5.19	-	-	3.6	13.5	14.0	950	3680	3920	16.7	16.0	15.3
	20+25+35+60	1.93	2.41	3.38	5.79	-	-	3.6	13.5	14.0	950	3670	3920	16.7	16.0	15.3
	20+25+50+50	1.86	2.33	4.66	4.66	-	-	3.6	13.5	14.0	950	3670	3920	16.7	16.0	15.3
	20+25+50+60	1.74	2.18	4.35	5.23	-	-	3.6	13.5	14.0	950	3670	3920	16.7	16.0	15.3
	20+25+60+60	1.64	2.05	4.91	4.91	-	-	3.6	13.5	14.0	950	3660	3920	16.7	15.9	15.3
	20+35+35+35	2.16	3.78	3.78	3.78	-	-	3.6	13.5	14.0	950	3680	3920	16.7	16.0	15.3
	20+35+35+50	1.93	3.38	3.38	4.82	-	-	3.6	13.5	14.0	950	3670	3920	16.7	16.0	15.3
	20+35+35+60	1.80	3.15	3.15	5.40	-	-	3.6	13.5	14.0	950	3670	3920	16.7	16.0	15.3
	20+35+50+50	1.74	3.05	4.35	4.35	-	-	3.6	13.5	14.0	950	3670	3920	16.7	16.0	15.3
	20+35+50+60	1.64	2.86	4.09	4.91	-	-	3.6	13.5	14.0	950	3660	3920	16.7	15.9	15.3
	20+35+60+60	1.54	2.70	4.63	4.63	-	-	3.6	13.5	14.0	950	3660	3920	16.7	15.9	15.3
	20+50+50+50	1.59	3.97	3.97	3.97	-	-	3.6	13.5	14.0	950	3660	3920	16.7	15.9	15.3
	20+50+50+60	1.50	3.75	3.75	4.50	-	-	3.6	13.5	14.0	950	3660	3920	16.7	15.9	15.3
	20+50+60+60	1.42	3.55	4.26	4.26	-	-	3.6	13.5	14.0	950	3650	3920	16.6	15.9	15.2
	25+25+25+25	3.38	3.38	3.38	3.38	-	-	3.6	13.5	14.0	950	3700	3920	16.8	16.1	15.4
	25+25+25+35	3.07	3.07	3.07	4.30	-	-	3.6	13.5	14.0	950	3690	3920	16.8	16.1	15.4
	25+25+25+50	2.70	2.70	2.70	5.40	-	-	3.6	13.5	14.0	950	3680	3920	16.7	16.0	15.3
	25+25+25+60	2.50	2.50	2.50	6.00	-	-	3.6	13.5	14.0	950	3680	3920	16.7	16.0	15.3
	25+25+35+35	2.81	2.81	3.94	3.94	-	-	3.6	13.5	14.0	950	3690	3920	16.8	16.1	15.4
	25+25+35+50	2.50	2.50	3.50	5.00	-	-	3.6	13.5	14.0	950	3680	3920	16.7	16.0	15.3
25+25+35+60	2.33	2.33	3.26	5.59	-	-	3.6	13.5	14.0	950	3670	3920	16.7	16.0	15.3	
25+25+50+50	2.25	2.25	4.50	4.50	-	-	3.6	13.5	14.0	950	3670	3920	16.7	16.0	15.3	
25+25+50+60	2.11	2.11	4.22	5.06	-	-	3.6	13.5	14.0	950	3670	3920	16.7	16.0	15.3	
25+25+60+60	1.99	1.99	4.76	4.76	-	-	3.6	13.5	14.0	950	3660	3920	16.7	15.9	15.3	
25+35+35+35	2.60	3.63	3.63	3.63	-	-	3.6	13.5	14.0	950	3680	3920	16.7	16.0	15.3	
25+35+35+50	2.33	3.26	3.26	4.66	-	-	3.6	13.5	14.0	950	3670	3920	16.7	16.0	15.3	
25+35+35+60	2.18	3.05	3.05	5.23	-	-	3.6	13.5	14.0	950	3670	3920	16.7	16.0	15.3	
25+35+50+50	2.11	2.95	4.22	4.22	-	-	3.6	13.5	14.0	950	3670	3920	16.7	16.0	15.3	
25+35+50+60	1.99	2.78	3.97	4.76	-	-	3.6	13.5	14.0	950	3660	3920	16.7	15.9	15.3	
25+35+60+60	1.88	2.63	4.50	4.50	-	-	3.6	13.5	14.0	950	3660	3920	16.7	15.9	15.3	
25+50+50+50	1.93	3.86	3.86	3.86	-	-	3.6	13.5	14.0	950	3660	3920	16.7	15.9	15.3	
25+50+50+60	1.82	3.65	3.65	4.38	-	-	3.6	13.5	14.0	950	3650	3920	16.6	15.9	15.2	
25+50+60+60	1.73	3.46	4.15	4.15	-	-	3.6	13.5	14.0	950	3650	3920	16.6	15.9	15.2	
35+35+35+35	3.38	3.38	3.38	3.38	-	-	3.6	13.5	14.0	950	3670	3920	16.7	16.0	15.3	
35+35+35+50	3.05	3.05	3.05	4.35	-	-	3.6	13.5	14.0	950	3670	3920	16.7	16.0	15.3	
35+35+35+60	2.86	2.86	2.86	4.91	-	-	3.6	13.5	14.0	950	3660	3920	16.7	15.9	15.3	
35+35+50+50	2.78	2.78	3.97	3.97	-	-	3.6	13.5	14.0	950	3660	3920	16.7	15.9	15.3	



MULTI-SPLIT SYSTEM

Indoor unit combination		Heating capacity (kW)									Power consumption(W)			Standard current(A)		
		Room heating capacity						Total capacity			Min.	Standard	Max.	220V	230V	240V
		A	B	C	D	E	F	Min.	Standard	Max.						
4 room	35+35+50+60	2.63	2.63	3.75	4.50	-	-	3.6	13.5	14.0	950	3660	3920	16.7	15.9	15.3
	35+35+60+60	2.49	2.49	4.26	4.26	-	-	3.6	13.5	14.0	950	3650	3920	16.6	15.9	15.2
	35+50+50+60	2.55	3.65	3.65	3.65	-	-	3.6	13.5	14.0	950	3650	3920	16.6	15.9	15.2
	35+50+50+60	2.42	3.46	3.46	4.15	-	-	3.6	13.5	14.0	950	3650	3920	16.6	15.9	15.2
Heating operation 5 room	20+20+20+20+20	2.70	2.70	2.70	2.70	2.70	-	4.0	13.5	14.0	1050	3380	3470	15.4	14.7	14.1
	20+20+20+20+25	2.57	2.57	2.57	2.57	3.21	-	4.0	13.5	14.0	1050	3380	3470	15.4	14.7	14.1
	20+20+20+20+35	2.35	2.35	2.35	2.35	4.11	-	4.0	13.5	14.0	1050	3370	3470	15.3	14.7	14.1
	20+20+20+20+50	2.08	2.08	2.08	2.08	5.19	-	4.0	13.5	14.0	1050	3360	3470	15.3	14.6	14.0
	20+20+20+20+60	1.93	1.93	1.93	1.93	5.79	-	4.0	13.5	14.0	1050	3360	3470	15.3	14.6	14.0
	20+20+20+25+25	2.45	2.45	2.45	3.07	3.07	-	4.0	13.5	14.0	1050	3380	3470	15.4	14.7	14.1
	20+20+20+25+35	2.25	2.25	2.25	2.81	3.94	-	4.0	13.5	14.0	1050	3370	3470	15.3	14.7	14.1
	20+20+20+25+50	2.00	2.00	2.00	2.50	5.00	-	4.0	13.5	14.0	1050	3360	3470	15.3	14.6	14.0
	20+20+20+25+60	1.86	1.86	1.86	2.33	5.59	-	4.0	13.5	14.0	1050	3350	3470	15.2	14.6	14.0
	20+20+20+35+35	2.08	2.08	2.08	3.63	3.63	-	4.0	13.5	14.0	1050	3360	3470	15.3	14.6	14.0
	20+20+20+35+50	1.86	1.86	1.86	3.26	4.66	-	4.0	13.5	14.0	1050	3350	3470	15.2	14.6	14.0
	20+20+20+35+60	1.74	1.74	1.74	3.05	5.23	-	4.0	13.5	14.0	1050	3350	3470	15.2	14.6	14.0
	20+20+20+50+50	1.69	1.69	1.69	4.22	4.22	-	4.0	13.5	14.0	1050	3340	3470	15.2	14.5	13.9
	20+20+20+50+60	1.59	1.59	1.59	3.97	4.76	-	4.0	13.5	14.0	1050	3340	3470	15.2	14.5	13.9
	20+20+20+60+60	1.50	1.50	1.50	4.50	4.50	-	4.0	13.5	14.0	1050	3330	3470	15.2	14.5	13.9
	20+20+25+25+25	2.35	2.35	2.93	2.93	2.93	-	4.0	13.5	14.0	1050	3370	3470	15.3	14.7	14.1
	20+20+25+25+35	2.16	2.16	2.70	2.70	3.78	-	4.0	13.5	14.0	1050	3370	3470	15.3	14.7	14.1
	20+20+25+25+50	1.93	1.93	2.41	2.41	4.82	-	4.0	13.5	14.0	1050	3360	3470	15.3	14.6	14.0
	20+20+25+25+60	1.80	1.80	2.25	2.25	5.40	-	4.0	13.5	14.0	1050	3350	3470	15.2	14.6	14.0
	20+20+25+35+35	2.00	2.00	2.50	3.50	3.50	-	4.0	13.5	14.0	1050	3360	3470	15.3	14.6	14.0
	20+20+25+35+50	1.80	1.80	2.25	3.15	4.50	-	4.0	13.5	14.0	1050	3350	3470	15.2	14.6	14.0
	20+20+25+35+60	1.69	1.69	2.11	2.95	5.06	-	4.0	13.5	14.0	1050	3340	3470	15.2	14.5	13.9
	20+20+25+50+50	1.64	1.64	2.05	4.09	4.09	-	4.0	13.5	14.0	1050	3340	3470	15.2	14.5	13.9
	20+20+25+50+60	1.54	1.54	1.93	3.86	4.63	-	4.0	13.5	14.0	1050	3340	3470	15.2	14.5	13.9
	20+20+25+60+60	1.46	1.46	1.82	4.38	4.38	-	4.0	13.5	14.0	1050	3330	3470	15.2	14.5	13.9
	20+20+35+35+35	1.86	1.86	3.26	3.26	3.26	-	4.0	13.5	14.0	1050	3350	3470	15.2	14.6	14.0
	20+20+35+35+50	1.69	1.69	2.95	2.95	4.22	-	4.0	13.5	14.0	1050	3340	3470	15.2	14.5	13.9
	20+20+35+35+60	1.59	1.59	2.78	2.78	4.76	-	4.0	13.5	14.0	1050	3340	3470	15.2	14.5	13.9
	20+20+35+50+50	1.54	1.54	2.70	3.86	3.86	-	4.0	13.5	14.0	1050	3340	3470	15.2	14.5	13.9
	20+20+35+50+60	1.46	1.46	2.55	3.65	4.38	-	4.0	13.5	14.0	1050	3330	3470	15.2	14.5	13.9
	20+20+35+60+60	1.38	1.38	2.42	4.15	4.15	-	4.0	13.5	14.0	1050	3320	3470	15.1	14.4	13.8
	20+20+50+50+50	1.42	1.42	3.55	3.55	3.55	-	4.0	13.5	14.0	1050	3320	3470	15.1	14.4	13.8
	20+25+25+25+25	2.25	2.81	2.81	2.81	2.81	-	4.0	13.5	14.0	1050	3370	3470	15.3	14.7	14.1
	20+25+25+25+35	2.08	2.60	2.60	2.60	3.63	-	4.0	13.5	14.0	1050	3360	3470	15.3	14.6	14.0
	20+25+25+25+50	1.86	2.33	2.33	2.33	4.66	-	4.0	13.5	14.0	1050	3350	3470	15.2	14.6	14.0
	20+25+25+25+60	1.74	2.18	2.18	2.18	5.23	-	4.0	13.5	14.0	1050	3350	3470	15.2	14.6	14.0
	20+25+25+35+35	1.93	2.41	2.41	3.38	3.38	-	4.0	13.5	14.0	1050	3360	3470	15.3	14.6	14.0
	20+25+25+35+50	1.74	2.18	2.18	3.05	4.35	-	4.0	13.5	14.0	1050	3350	3470	15.2	14.6	14.0
	20+25+25+35+60	1.64	2.05	2.05	2.86	4.91	-	4.0	13.5	14.0	1050	3340	3470	15.2	14.5	13.9
	20+25+25+50+50	1.59	1.99	1.99	3.97	3.97	-	4.0	13.5	14.0	1050	3340	3470	15.2	14.5	13.9
	20+25+25+50+60	1.50	1.88	1.88	3.75	4.50	-	4.0	13.5	14.0	1050	3330	3470	15.2	14.5	13.9
	20+25+25+60+60	1.42	1.78	1.78	4.26	4.26	-	4.0	13.5	14.0	1050	3320	3470	15.1	14.4	13.8
	20+25+35+35+35	1.80	2.25	3.15	3.15	3.15	-	4.0	13.5	14.0	1050	3350	3470	15.2	14.6	14.0
	20+25+35+35+50	1.64	2.05	2.86	2.86	4.09	-	4.0	13.5	14.0	1050	3340	3470	15.2	14.5	13.9
	20+25+35+35+60	1.54	1.93	2.70	2.70	4.63	-	4.0	13.5	14.0	1050	3340	3470	15.2	14.5	13.9
	20+25+35+50+50	1.50	1.88	2.63	3.75	3.75	-	4.0	13.5	14.0	1050	3330	3470	15.2	14.5	13.9
	20+25+35+50+60	1.42	1.78	2.49	3.55	4.26	-	4.0	13.5	14.0	1050	3320	3470	15.1	14.4	13.8
	20+25+50+50+50	1.38	1.73	3.46	3.46	3.46	-	4.0	13.5	14.0	1050	3320	3470	15.1	14.4	13.8
20+35+35+35+35	1.69	2.95	2.95	2.95	2.95	-	4.0	13.5	14.0	1050	3340	3470	15.2	14.5	13.9	
20+35+35+35+50	1.54	2.70	2.70	2.70	3.86	-	4.0	13.5	14.0	1050	3340	3470	15.2	14.5	13.9	
20+35+35+35+60	1.46	2.55	2.55	2.55	4.38	-	4.0	13.5	14.0	1050	3330	3470	15.2	14.5	13.9	
20+35+35+50+50	1.42	2.49	2.49	3.55	3.55	-	4.0	13.5	14.0	1050	3320	3470	15.1	14.4	13.8	
25+25+25+25+25	2.70	2.70	2.70	2.70	2.70	-	4.0	13.5	14.0	1050	3370	3470	15.3	14.7	14.1	
25+25+25+25+35	2.50	2.50	2.50	2.50	3.50	-	4.0	13.5	14.0	1050	3360	3470	15.3	14.6	14.0	
25+25+25+25+50	2.25	2.25	2.25	2.25	4.50	-	4.0	13.5	14.0	1050	3350	3470	15.2	14.6	14.0	
25+25+25+25+60	2.11	2.11	2.11	2.11	5.06	-	4.0	13.5	14.0	1050	3340	3470	15.2	14.5	13.9	
25+25+25+35+35	2.33	2.33	2.33	3.26	3.26	-	4.0	13.5	14.0	1050	3350	3470	15.2	14.6	14.0	
25+25+25+35+50	2.11	2.11	2.11	2.95	4.22	-	4.0	13.5	14.0	1050	3340	3470	15.2	14.5	13.9	
25+25+25+35+60	1.99	1.99	1.99	2.78	4.76	-	4.0	13.5	14.0	1050	3340	3470	15.2	14.5	13.9	
25+25+25+50+50	1.93	1.93	1.93	3.86	3.86	-	4.0	13.5	14.0	1050	3340	3470	15.2	14.5	13.9	
25+25+25+50+60	1.82	1.82	1.82	3.65	4.38	-	4.0	13.5	14.0	1050	3330	3470	15.2	14.5	13.9	
25+25+35+35+35	1.73	1.73	1.73	4.15	4.15	-	4.0	13.5	14.0	1050	3320	3470	15.1	14.4	13.8	
25+25+35+35+50	2.18	2.18	3.05	3.05	3.05	-	4.0	13.5	14.0	1050	3350	3470	15.2	14.6	14.0	
25+25+35+35+60	1.99	1.99	2.78	2.78	3.97	-	4.0	13.5	14.0	1050	3340	3470	15.2	14.5	13.9	
25+25+35+50+50	1.88	1.88	2.63	2.63	4.50	-	4.0	13.5	14.0	1050	3330	3470	15.2	14.5	13.9	
25+25+35+50+60	1.82	1.82	2.55	3.65	3.65	-	4.0	13.5	14.0	1050	3330	3470	15.2	14.5	13.9	
25+25+35+60+60	1.73	1.73	2.42	3.46	4.15	-	4.0	13.5	14.0	1050	3320	3470	15.1	14.4	13.8	
25+35+35+35+35	2.05	2.86	2.86	2.86	2.86	-	4.0	13.5	14.0	1050	3340	3470	15.2	14.5	13.9	
25+35+35+35+50	1.88	2.63	2.63	2.63	3.75	-	4.0	13.5	14.0	1050	3330	3470	15.2	14.5	13.9	
25+35+35+35+60	1.78	2.49	2.49	2.49	4.26	-	4.0	13.5	14.0	1050	3320	3470	15.1	14.4	13.8	
25+35+35+50+50	1.73	2.42	2.42	3.46	3.46	-	4.0	13.5	14.0	1050	3320	3470	15.1	14.4	13.8	
25+35+35+50+60	2.70															

COMBINATIONS

Indoor unit combination		Heating capacity (kW)									Power consumption(W)			Standard current(A)			
		Room heating capacity						Total capacity			Min.	Standard	Max.	220V	230V	240V	
		A	B	C	D	E	F	Min.	Standard	Max.							
Heating operation	6 room	20+20+20+20+20+20	2.25	2.25	2.25	2.25	2.25	2.25	4.5	13.5	14.0	1150	3260	3420	14.8	14.2	13.6
		20+20+20+20+20+25	2.16	2.16	2.16	2.16	2.16	2.70	4.5	13.5	14.0	1150	3250	3420	14.8	14.1	13.6
		20+20+20+20+20+35	2.00	2.00	2.00	2.00	2.00	3.50	4.5	13.5	14.0	1150	3250	3420	14.8	14.1	13.6
		20+20+20+20+20+50	1.80	1.80	1.80	1.80	1.80	4.50	4.5	13.5	14.0	1150	3250	3420	14.8	14.1	13.6
		20+20+20+20+20+60	1.69	1.69	1.69	1.69	1.69	5.06	4.5	13.5	14.0	1150	3240	3420	14.7	14.1	13.5
		20+20+20+20+25+25	2.08	2.08	2.08	2.08	2.60	2.60	4.5	13.5	14.0	1150	3250	3420	14.8	14.1	13.6
		20+20+20+20+25+35	1.93	1.93	1.93	1.93	2.41	3.38	4.5	13.5	14.0	1150	3250	3420	14.8	14.1	13.6
		20+20+20+20+25+50	1.74	1.74	1.74	1.74	2.18	4.35	4.5	13.5	14.0	1150	3240	3420	14.7	14.1	13.5
		20+20+20+20+25+60	1.64	1.64	1.64	1.64	2.05	4.91	4.5	13.5	14.0	1150	3240	3420	14.7	14.1	13.5
		20+20+20+20+35+35	1.80	1.80	1.80	1.80	3.15	3.15	4.5	13.5	14.0	1150	3250	3420	14.8	14.1	13.6
		20+20+20+20+35+50	1.64	1.64	1.64	1.64	2.86	4.09	4.5	13.5	14.0	1150	3240	3420	14.7	14.1	13.5
		20+20+20+20+35+60	1.54	1.54	1.54	1.54	2.70	4.63	4.5	13.5	14.0	1150	3230	3420	14.7	14.1	13.5
		20+20+20+20+50+50	1.50	1.50	1.50	1.50	3.75	3.75	4.5	13.5	14.0	1150	3230	3420	14.7	14.1	13.5
		20+20+20+20+50+60	1.42	1.42	1.42	1.42	3.55	4.26	4.5	13.5	14.0	1150	3230	3420	14.7	14.1	13.5
		20+20+20+25+25+25	2.00	2.00	2.00	2.50	2.50	2.50	4.5	13.5	14.0	1150	3250	3420	14.8	14.1	13.6
		20+20+20+25+25+35	1.86	1.86	1.86	2.33	2.33	3.26	4.5	13.5	14.0	1150	3250	3420	14.8	14.1	13.6
		20+20+20+25+25+50	1.69	1.69	1.69	2.11	2.11	4.22	4.5	13.5	14.0	1150	3240	3420	14.7	14.1	13.5
		20+20+20+25+25+60	1.59	1.59	1.59	1.99	1.99	4.76	4.5	13.5	14.0	1150	3240	3420	14.7	14.1	13.5
		20+20+20+25+35+35	1.74	1.74	1.74	2.18	3.05	3.05	4.5	13.5	14.0	1150	3240	3420	14.7	14.1	13.5
		20+20+20+25+35+50	1.59	1.59	1.59	1.99	2.78	3.97	4.5	13.5	14.0	1150	3240	3420	14.7	14.1	13.5
		20+20+20+25+35+60	1.50	1.50	1.50	1.88	2.63	4.50	4.5	13.5	14.0	1150	3230	3420	14.7	14.1	13.5
		20+20+20+25+50+50	1.46	1.46	1.46	1.82	3.65	3.65	4.5	13.5	14.0	1150	3230	3420	14.7	14.1	13.5
		20+20+20+25+50+60	1.38	1.38	1.38	1.73	3.46	4.15	4.5	13.5	14.0	1150	3220	3420	14.7	14.0	13.4
		20+20+20+35+35+35	1.64	1.64	1.64	2.86	2.86	2.86	4.5	13.5	14.0	1150	3240	3420	14.7	14.1	13.5
		20+20+20+35+35+50	1.50	1.50	1.50	2.63	2.63	3.75	4.5	13.5	14.0	1150	3230	3420	14.7	14.1	13.5
		20+20+20+35+35+60	1.42	1.42	1.42	2.49	2.49	4.26	4.5	13.5	14.0	1150	3230	3420	14.7	14.1	13.5
		20+20+20+35+50+50	1.38	1.38	1.38	2.42	3.46	3.46	4.5	13.5	14.0	1150	3220	3420	14.7	14.0	13.4
		20+20+25+25+25+25	1.93	1.93	2.41	2.41	2.41	2.41	4.5	13.5	14.0	1150	3250	3420	14.8	14.1	13.6
		20+20+25+25+25+35	1.80	1.80	2.25	2.25	2.25	3.15	4.5	13.5	14.0	1150	3250	3420	14.8	14.1	13.6
		20+20+25+25+25+50	1.64	1.64	2.05	2.05	2.05	4.09	4.5	13.5	14.0	1150	3240	3420	14.7	14.1	13.5
		20+20+25+25+25+60	1.54	1.54	1.93	1.93	1.93	4.63	4.5	13.5	14.0	1150	3230	3420	14.7	14.1	13.5
		20+20+25+25+35+35	1.69	1.69	2.11	2.11	2.95	2.95	4.5	13.5	14.0	1150	3240	3420	14.7	14.1	13.5
		20+20+25+25+35+50	1.54	1.54	1.93	1.93	2.70	3.86	4.5	13.5	14.0	1150	3230	3420	14.7	14.1	13.5
		20+20+25+25+35+60	1.46	1.46	1.82	1.82	2.55	4.38	4.5	13.5	14.0	1150	3230	3420	14.7	14.1	13.5
		20+20+25+25+50+50	1.42	1.42	1.78	1.78	3.55	3.55	4.5	13.5	14.0	1150	3230	3420	14.7	14.1	13.5
		20+20+25+25+50+60	1.59	1.59	1.99	2.78	2.78	2.78	4.5	13.5	14.0	1150	3240	3420	14.7	14.1	13.5
		20+20+25+35+35+50	1.46	1.46	1.82	2.55	2.55	3.65	4.5	13.5	14.0	1150	3230	3420	14.7	14.1	13.5
		20+20+25+35+35+60	1.38	1.38	1.73	2.42	2.42	4.15	4.5	13.5	14.0	1150	3220	3420	14.7	14.0	13.4
		20+20+35+35+35+35	1.50	1.50	2.63	2.63	2.63	2.63	4.5	13.5	14.0	1150	3230	3420	14.7	14.1	13.5
		20+20+35+35+35+50	1.38	1.38	2.42	2.42	3.46	3.46	4.5	13.5	14.0	1150	3220	3420	14.7	14.0	13.4
		20+25+25+25+25+25	1.86	2.33	2.33	2.33	2.33	2.33	4.5	13.5	14.0	1150	3250	3420	14.8	14.1	13.6
		20+25+25+25+25+35	1.74	2.18	2.18	2.18	2.18	3.05	4.5	13.5	14.0	1150	3240	3420	14.7	14.1	13.5
		20+25+25+25+25+50	1.59	1.99	1.99	1.99	1.99	3.97	4.5	13.5	14.0	1150	3240	3420	14.7	14.1	13.5
		20+25+25+25+25+60	1.50	1.88	1.88	1.88	1.88	4.50	4.5	13.5	14.0	1150	3230	3420	14.7	14.1	13.5
		20+25+25+25+35+35	1.64	2.05	2.05	2.05	2.86	2.86	4.5	13.5	14.0	1150	3240	3420	14.7	14.1	13.5
		20+25+25+25+35+50	1.50	1.88	1.88	1.88	2.63	3.75	4.5	13.5	14.0	1150	3230	3420	14.7	14.1	13.5
		20+25+25+25+35+60	1.42	1.78	1.78	1.78	2.49	4.26	4.5	13.5	14.0	1150	3230	3420	14.7	14.1	13.5
		20+25+25+25+50+50	1.38	1.73	1.73	1.73	3.46	3.46	4.5	13.5	14.0	1150	3220	3420	14.7	14.0	13.4
		20+25+25+35+35+35	1.54	1.93	1.93	2.70	2.70	2.70	4.5	13.5	14.0	1150	3230	3420	14.7	14.1	13.5
		20+25+25+35+35+50	1.42	1.78	1.78	2.49	2.49	3.55	4.5	13.5	14.0	1150	3230	3420	14.7	14.1	13.5
20+25+35+35+35+35	1.46	1.82	2.55	2.55	2.55	2.55	4.5	13.5	14.0	1150	3230	3420	14.7	14.1	13.5		
20+35+35+35+35+35	1.38	2.42	2.42	2.42	2.42	2.42	4.5	13.5	14.0	1150	3220	3420	14.7	14.0	13.4		
25+25+25+25+25+25	2.25	2.25	2.25	2.25	2.25	2.25	4.5	13.5	14.0	1150	3240	3420	14.7	14.1	13.5		
25+25+25+25+25+35	2.11	2.11	2.11	2.11	2.11	2.95	4.5	13.5	14.0	1150	3240	3420	14.7	14.1	13.5		
25+25+25+25+25+50	1.93	1.93	1.93	1.93	1.93	3.86	4.5	13.5	14.0	1150	3230	3420	14.7	14.1	13.5		
25+25+25+25+25+60	1.82	1.82	1.82	1.82	1.82	4.38	4.5	13.5	14.0	1150	3230	3420	14.7	14.1	13.5		
25+25+25+25+35+35	1.99	1.99	1.99	1.99	2.78	2.78	4.5	13.5	14.0	1150	3240	3420	14.7	14.1	13.5		
25+25+25+25+35+50	1.82	1.82	1.82	1.82	2.55	3.65	4.5	13.5	14.0	1150	3230	3420	14.7	14.1	13.5		
25+25+25+25+35+60	1.73	1.73	1.73	1.73	2.42	4.15	4.5	13.5	14.0	1150	3220	3420	14.7	14.0	13.4		
25+25+25+35+35+35	1.88	1.88	1.88	2.63	2.63	2.63	4.5	13.5	14.0	1150	3230	3420	14.7	14.1	13.5		
25+25+25+35+35+50	1.73	1.73	1.73	2.42	2.42	3.46	4.5	13.5	14.0	1150	3220	3420	14.7	14.0	13.4		
25+25+35+35+35+35	1.78	1.78	2.49	2.49	2.49	2.49	4.5	13.5	14.0	1150	3230	3420	14.7	14.1	13.5		

Indoor unit combination		Cooling capacity (kW)									Power consumption(W)			Standard current(A)		
		Room cooling capacity						Total capacity			Min.	Standard	Max.	220V	230V	240V
		A	B	C	D	E	F	Min.	Standard	Max.						
Cooling operation	1 room	20	2.0	-	-	-	-	1.8	2.0	2.8	650	750	1100	3.4	3.3	3.2
		25	2.5	-	-	-	-	1.8	2.5	3.4	650	950	1350	4.4	4.2	4.0
		35	3.5	-	-	-	-	1.8	3.5	3.9	650	1400	1600	6.4	6.1	5.9
		50	5.0	-	-	-	-	1.8	5.0	6.1	650	2000	2500	9.2	8.8	8.4
		60	6.0	-	-	-	-	1.8	6.0	7.0	650	2450	3000	11.2	10.8	10.3
	2 room	20+20	2.00	2.00	-	-	-	3.0	4.0	5.6	740	910	1460	4.2	4.0	3.8
		20+25	2.00	2.50	-	-	-	3.0	4.5	6.2	740	1050	1820	4.8	4.6	4.4
		20+35	2.00	3.50	-	-	-	3.0	5.5	6.7	740	1430	2020	6.6	6.3	6.0
		20+50	2.00	5.00	-	-	-	3.0	7.0	8.9	740	2180	2820	10.0	9.6	9.2
		20+60	2.00	6.00	-	-	-	3.0	8.0	9.8	740	2530	3360	11.6	11.1	10.6
		25+25	2.50	2.50	-	-	-	3.0	5.0	6.8	740	1350	2200	6.2	5.9	5.7



MULTI-SPLIT SYSTEM

Indoor unit combination		Cooling capacity (kW)									Power consumption(W)			Standard current(A)		
		Room cooling capacity						Total capacity			Min.	Standard	Max.	220V	230V	240V
		A	B	C	D	E	F	Min.	Standard	Max.						
2 room	25+35	2.50	3.50	-	-	-	-	3.0	6.0	7.3	740	1720	2320	7.9	7.6	7.2
	25+50	2.50	5.00	-	-	-	-	3.0	7.5	9.5	740	2350	3220	10.8	10.3	9.9
	25+60	2.50	6.00	-	-	-	-	3.0	8.5	9.8	740	2680	3360	12.3	11.8	11.3
	35+35	3.50	3.50	-	-	-	-	3.0	7.0	7.8	740	2180	2820	10.0	9.6	9.2
	35+50	3.50	5.00	-	-	-	-	3.0	8.5	10.0	740	2680	3620	12.3	11.8	11.3
	35+60	3.50	6.00	-	-	-	-	3.0	9.5	10.9	740	3120	3990	14.3	13.7	13.1
	50+50	5.00	5.00	-	-	-	-	3.0	10.0	12.2	740	3350	4450	15.4	14.7	14.1
3 room	50+60	5.00	6.00	-	-	-	-	3.0	11.0	12.5	740	3685	4520	16.9	16.2	15.5
	60+60	6.00	6.00	-	-	-	-	3.0	12.0	12.5	740	4200	4520	19.3	18.4	17.7
	20+20+20	2.00	2.00	2.00	-	-	-	3.7	6.0	8.4	880	1460	2560	6.7	6.4	6.1
	20+20+25	2.00	2.00	2.50	-	-	-	3.7	6.5	9.0	880	1650	2700	7.6	7.2	6.9
	20+20+35	2.00	2.00	3.50	-	-	-	3.7	7.5	9.5	880	1980	3120	9.1	8.7	8.3
	20+20+50	2.00	2.00	5.00	-	-	-	3.7	9.0	11.7	880	2600	4120	11.9	11.4	10.9
	20+20+60	2.00	2.00	6.00	-	-	-	3.7	10.0	12.6	880	3120	4680	14.3	13.7	13.1
	20+25+25	2.00	2.50	2.50	-	-	-	3.7	7.0	9.6	880	1850	3210	8.5	8.1	7.8
	20+25+35	2.00	2.50	3.50	-	-	-	3.7	8.0	10.1	880	2320	3630	10.7	10.2	9.8
	20+25+50	2.00	2.50	5.00	-	-	-	3.7	9.5	12.3	880	2980	4510	13.7	13.1	12.5
	20+25+60	2.00	2.50	6.00	-	-	-	3.7	10.5	12.8	880	3590	4800	16.5	15.8	15.1
	20+35+35	2.00	3.50	3.50	-	-	-	3.7	9.0	10.6	880	2780	4120	12.8	12.2	11.7
	20+35+50	2.00	3.50	5.00	-	-	-	3.7	10.5	12.8	880	3590	4800	16.5	15.8	15.1
	20+35+60	2.00	3.50	6.00	-	-	-	3.7	11.5	12.8	880	3950	4800	18.1	17.3	16.6
	20+50+50	2.00	5.00	5.00	-	-	-	3.7	12.0	12.8	880	4230	4800	19.4	18.6	17.8
	20+50+60	1.92	4.81	5.77	-	-	-	3.7	12.5	12.8	880	4450	4800	20.4	19.5	18.7
	20+60+60	1.79	5.36	5.36	-	-	-	3.7	12.5	12.8	880	4450	4800	20.4	19.5	18.7
	25+25+25	2.50	2.50	2.50	-	-	-	3.7	7.5	10.2	880	2030	3640	9.3	8.9	8.5
	25+25+35	2.50	2.50	3.50	-	-	-	3.7	8.5	10.7	880	2520	3900	11.6	11.1	10.6
	25+25+50	2.50	2.50	5.00	-	-	-	3.7	10.0	12.8	880	3260	4800	15.0	14.3	13.7
	25+25+60	2.50	2.50	6.00	-	-	-	3.7	11.0	12.8	880	3720	4800	17.1	16.3	15.7
	25+35+35	2.50	3.50	3.50	-	-	-	3.7	9.5	11.2	880	2980	4510	13.7	13.1	12.5
	25+35+50	2.50	3.50	5.00	-	-	-	3.7	11.0	12.8	880	3720	4800	17.1	16.3	15.7
	25+35+60	2.50	3.50	6.00	-	-	-	3.7	12.0	12.8	880	4230	4800	19.4	18.6	17.8
	25+50+50	2.50	5.00	5.00	-	-	-	3.7	12.5	12.8	880	4450	4800	20.4	19.5	18.7
	25+50+60	2.31	4.63	5.56	-	-	-	3.7	12.5	12.8	880	4450	4800	20.4	19.5	18.7
	25+60+60	2.16	5.17	5.17	-	-	-	3.7	12.5	12.8	880	4450	4800	20.4	19.5	18.7
	35+35+35	3.50	3.50	3.50	-	-	-	3.7	10.5	11.7	880	3590	4180	16.5	15.8	15.1
	35+35+50	3.50	3.50	5.00	-	-	-	3.7	12.0	12.8	880	4230	4800	19.4	18.6	17.8
	35+35+60	3.37	3.37	5.77	-	-	-	3.7	12.5	12.8	880	4450	4800	20.4	19.5	18.7
	35+50+50	3.24	4.63	4.63	-	-	-	3.7	12.5	12.8	880	4450	4800	20.4	19.5	18.7
	35+50+60	3.02	4.31	5.17	-	-	-	3.7	12.5	12.8	880	4450	4800	20.2	19.3	18.5
	35+60+60	2.82	4.84	4.84	-	-	-	3.7	12.5	12.8	880	4450	4800	20.2	19.3	18.5
50+50+50	4.17	4.17	4.17	-	-	-	3.7	12.5	12.8	880	4440	4800	20.4	19.5	18.7	
50+50+60	3.91	3.91	4.69	-	-	-	3.7	12.5	12.8	880	4440	4800	20.4	19.5	18.7	
50+60+60	3.68	4.41	4.41	-	-	-	3.7	12.5	12.8	880	4430	4800	20.3	19.5	18.6	
60+60+60	4.17	4.17	4.17	-	-	-	3.7	12.5	12.8	880	4430	4800	20.3	19.5	18.6	
4 room	20+20+20+20	2.00	2.00	2.00	2.00	-	-	4.4	8.0	11.2	1100	2050	3680	9.3	8.9	8.6
	20+20+20+25	2.00	2.00	2.00	2.50	-	-	4.4	8.5	11.8	1100	2320	3890	10.6	10.1	9.7
	20+20+20+35	2.00	2.00	2.00	3.50	-	-	4.4	9.5	12.3	1100	2820	4530	12.8	12.3	11.8
	20+20+20+50	2.00	2.00	2.00	5.00	-	-	4.4	11.0	13.0	1100	3480	4800	15.8	15.1	14.5
	20+20+20+60	2.00	2.00	2.00	6.00	-	-	4.4	12.0	13.0	1100	3980	4800	18.1	17.3	16.6
	20+20+25+25	2.00	2.00	2.50	2.50	-	-	4.4	9.0	12.4	1100	2520	4590	11.5	11.0	10.5
	20+20+25+35	2.00	2.00	2.50	3.50	-	-	4.4	10.0	12.9	1100	3120	4780	14.2	13.6	13.0
	20+20+25+50	2.00	2.00	2.50	5.00	-	-	4.4	11.5	13.0	1100	3720	4800	16.9	16.2	15.5
	20+20+25+60	2.00	2.00	2.50	6.00	-	-	4.4	12.5	13.0	1100	4600	4800	20.9	20.0	19.2
	20+20+35+35	2.00	2.00	3.50	3.50	-	-	4.4	11.0	13.0	1100	3480	4800	15.8	15.1	14.5
	20+20+35+50	2.00	2.00	3.50	5.00	-	-	4.4	12.5	13.0	1100	4600	4800	20.9	20.0	19.2
	20+20+35+60	1.85	1.85	3.24	5.56	-	-	4.4	12.5	13.0	1100	4590	4800	20.9	20.0	19.1
	20+20+50+50	1.79	1.79	4.46	4.46	-	-	4.4	12.5	13.0	1100	4590	4800	20.9	20.0	19.1
	20+20+50+60	1.67	1.67	4.17	5.00	-	-	4.4	12.5	13.0	1100	4590	4800	20.9	20.0	19.1
	20+20+60+60	1.56	1.56	4.69	4.69	-	-	4.4	12.5	13.0	1100	4580	4800	20.8	19.9	19.1
	20+25+25+25	2.00	2.50	2.50	2.50	-	-	4.4	9.5	13.0	1100	2820	4800	12.8	12.3	11.8
	20+25+25+35	2.00	2.50	2.50	3.50	-	-	4.4	10.5	13.0	1100	3340	4800	15.2	14.5	13.9
	20+25+25+50	2.00	2.50	2.50	5.00	-	-	4.4	12.0	13.0	1100	3980	4800	18.1	17.3	16.6
	20+25+25+60	1.92	2.40	2.40	5.77	-	-	4.4	12.5	13.0	1100	4600	4800	20.9	20.0	19.2
	20+25+35+35	2.00	2.50	3.50	3.50	-	-	4.4	11.5	13.0	1100	3720	4800	16.9	16.2	15.5
	20+25+35+50	1.92	2.40	3.37	4.81	-	-	4.4	12.5	13.0	1100	4600	4800	20.9	20.0	19.2
	20+25+35+60	1.79	2.23	3.13	5.36	-	-	4.4	12.5	13.0	1100	4590	4800	20.9	20.0	19.1
	20+25+50+50	1.72	2.16	4.31	4.31	-	-	4.4	12.5	13.0	1100	4590	4800	20.9	20.0	19.1
	20+25+50+60	1.61	2.02	4.03	4.84	-	-	4.4	12.5	13.0	1100	4580	4800	20.8	19.9	19.1
	20+25+60+60	1.52	1.89	4.55	4.55	-	-	4.4	12.5	13.0	1100	4580	4800	20.8	19.9	19.1
	20+35+35+35	2.00	3.50	3.50	3.50	-	-	4.4	12.5	13.0	1100	4600	4800	20.9	20.0	19.2
	20+35+35+50	1.79	3.13	3.13	4.46	-	-	4.4	12.5	13.0	1100	4590	4800	20.9	20.0	19.1
	20+35+35+60	1.67	2.92	2.92	5.00	-	-	4.4	12.5	13.0	1100	4590	4800	20.9	20.0	19.1
	20+35+50+50	1.61	2.82	4.03	4.03	-	-	4.4	12.5	13.0	1100	4580	4800	20.8	19.9	19.1
	20+35+50+60	1.52	2.65	3.79	4.55	-	-	4.4	12.5	13.0	1100	4580	4800	20.8	19.9	19.1
20+35+60+60	1.43	2.50	4.29	4.29	-	-	5.4	12.5	13.0	1100	4570	4800	20.6	19.7	18.9	
20+50+50+50	1.47	3.68	3.68	3.68	-	-	4.4	12.5</								

COMBINATIONS

Indoor unit combination		Cooling capacity (kW)									Power consumption(W)			Standard current(A)			
		Room cooling capacity						Total capacity			Min.	Standard	Max.	220V	230V	240V	
		A	B	C	D	E	F	Min.	Standard	Max.							
4 room	20+50+60+60	1.32	3.29	3.95	3.95	-	-	4.4	12.5	13.0	1100	4560	4800	20.7	19.8	19.0	
	25+25+25+25	2.50	2.50	2.50	2.50	-	-	4.4	10.0	13.0	1100	3120	4800	14.2	13.6	13.0	
	25+25+25+35	2.50	2.50	2.50	3.50	-	-	4.4	11.0	13.0	1100	3480	4800	15.8	15.1	14.5	
	25+25+25+50	2.50	2.50	2.50	5.00	-	-	4.4	12.5	13.0	1100	4600	4800	20.9	20.0	19.2	
	25+25+25+60	2.31	2.31	2.31	5.56	-	-	4.4	12.5	13.0	1100	4590	4800	20.9	20.0	19.1	
	25+25+35+35	2.50	2.50	3.50	3.50	-	-	4.4	12.0	13.0	1100	3980	4800	18.1	17.3	16.6	
	25+25+35+50	2.31	2.31	3.24	4.63	-	-	4.4	12.5	13.0	1100	4590	4800	20.9	20.0	19.1	
	25+25+35+60	2.16	2.16	3.02	5.17	-	-	4.4	12.5	13.0	1100	4590	4800	20.9	20.0	19.1	
	25+25+50+50	2.08	2.08	4.17	4.17	-	-	4.4	12.5	13.0	1100	4590	4800	20.9	20.0	19.1	
	25+25+50+60	1.95	1.95	3.91	4.69	-	-	4.4	12.5	13.0	1100	4580	4800	20.8	19.9	19.1	
	25+25+60+60	1.84	1.84	4.41	4.41	-	-	4.4	12.5	13.0	1100	4580	4800	20.8	19.9	19.1	
	25+35+35+35	2.40	3.37	3.37	3.37	-	-	4.4	12.5	13.0	1100	4600	4800	20.9	20.0	19.2	
	25+35+35+50	2.16	3.02	3.02	4.31	-	-	4.4	12.5	13.0	1100	4590	4800	20.9	20.0	19.1	
	25+35+35+60	2.02	2.82	2.82	4.84	-	-	4.4	12.5	13.0	1100	4580	4800	20.8	19.9	19.1	
	25+35+50+50	1.95	2.73	3.91	3.91	-	-	4.4	12.5	13.0	1100	4580	4800	20.8	19.9	19.1	
	25+35+50+60	1.84	2.57	3.68	4.41	-	-	4.4	12.5	13.0	1100	4580	4800	20.8	19.9	19.1	
	25+35+60+60	1.74	2.43	4.17	4.17	-	-	4.4	12.5	13.0	1100	4570	4800	20.8	19.9	19.1	
	25+50+50+50	1.79	3.57	3.57	3.57	-	-	4.4	12.5	13.0	1100	4570	4800	20.8	19.9	19.1	
	25+50+50+60	1.69	3.38	3.38	4.05	-	-	4.4	12.5	13.0	1100	4570	4800	20.8	19.9	19.1	
	25+50+60+60	1.60	3.21	3.85	3.85	-	-	4.4	12.5	13.0	1100	4560	4800	20.7	19.8	19.0	
	35+35+35+35	3.13	3.13	3.13	3.13	-	-	4.4	12.5	13.0	1100	4590	4800	20.9	20.0	19.1	
	35+35+35+50	2.82	2.82	2.82	4.03	-	-	4.4	12.5	13.0	1100	4580	4800	20.8	19.9	19.1	
	35+35+35+60	2.65	2.65	2.65	4.55	-	-	4.4	12.5	13.0	1100	4580	4800	20.8	19.9	19.1	
	35+35+50+50	2.57	2.57	3.68	3.68	-	-	4.4	12.5	13.0	1100	4580	4800	20.8	19.9	19.1	
	35+35+50+60	2.43	2.43	3.47	4.17	-	-	4.4	12.5	13.0	1100	4570	4800	20.8	19.9	19.1	
	35+35+60+60	2.30	2.30	3.95	3.95	-	-	4.4	12.5	13.0	1100	4560	4800	20.7	19.8	19.0	
	35+50+50+50	2.36	3.38	3.38	3.38	-	-	4.4	12.5	13.0	1100	4570	4800	20.8	19.9	19.1	
	35+50+50+60	2.24	3.21	3.21	3.85	-	-	4.4	12.5	13.0	1100	4560	4800	20.7	19.8	19.0	
	Cooling operation	20+20+20+20+20	2.00	2.00	2.00	2.00	2.00	-	5.1	10.0	13.5	1210	2880	4800	13.1	12.5	12.0
		20+20+20+20+25	2.00	2.00	2.00	2.00	2.50	-	5.1	10.5	13.5	1210	3120	4800	14.2	13.6	13.0
		20+20+20+20+35	2.00	2.00	2.00	2.00	3.50	-	5.1	11.5	13.5	1210	3620	4800	16.5	15.8	15.1
		20+20+20+20+50	1.92	1.92	1.92	1.92	4.81	-	5.1	12.5	13.5	1210	4320	4800	19.7	18.8	18.0
		20+20+20+20+60	1.79	1.79	1.79	1.79	5.36	-	5.1	12.5	13.5	1210	4310	4800	19.6	18.8	18.0
		20+20+20+25+25	2.00	2.00	2.00	2.50	2.50	-	5.1	11.0	13.5	1210	3320	4800	15.1	14.4	13.8
		20+20+20+25+35	2.00	2.00	2.00	2.50	3.50	-	5.1	12.0	13.5	1210	3990	4800	18.2	17.4	16.6
20+20+20+25+50		1.85	1.85	1.85	2.31	4.63	-	5.1	12.5	13.5	1210	4320	4800	19.7	18.8	18.0	
20+20+20+25+60		1.72	1.72	1.72	2.16	5.17	-	5.1	12.5	13.5	1210	4310	4800	19.6	18.8	18.0	
20+20+20+35+35		1.92	1.92	1.92	3.37	3.37	-	5.1	12.5	13.5	1210	4320	4800	19.7	18.8	18.0	
20+20+20+35+50		1.72	1.72	1.72	3.02	4.31	-	5.1	12.5	13.5	1210	4310	4800	19.6	18.8	18.0	
20+20+20+35+60		1.61	1.61	1.61	2.82	4.84	-	5.1	12.5	13.5	1210	4300	4800	19.6	18.7	17.9	
20+20+20+50+50		1.56	1.56	1.56	3.91	3.91	-	5.1	12.5	13.5	1210	4300	4800	19.6	18.7	17.9	
20+20+20+50+60		1.47	1.47	1.47	3.68	4.41	-	5.1	12.5	13.5	1210	4290	4800	19.5	18.7	17.9	
20+20+20+60+60		1.39	1.39	1.39	4.17	4.17	-	5.1	12.5	13.5	1210	4280	4800	19.5	18.6	17.9	
20+20+25+25+25		2.00	2.00	2.50	2.50	2.50	-	5.1	11.5	13.5	1210	3620	4800	16.5	15.8	15.1	
20+20+25+25+35		2.00	2.00	2.50	2.50	3.50	-	5.1	12.5	13.5	1210	4330	4800	19.7	18.8	18.1	
20+20+25+25+50		1.79	1.79	2.23	2.23	4.46	-	5.1	12.5	13.5	1210	4310	4800	19.6	18.8	18.0	
20+20+25+25+60		1.67	1.67	2.08	2.08	5.00	-	5.1	12.5	13.5	1210	4300	4800	19.6	18.7	17.9	
20+20+25+35+35		1.85	1.85	2.31	3.24	3.24	-	5.1	12.5	13.5	1210	4320	4800	19.7	18.8	18.0	
20+20+25+35+50		1.67	1.67	2.08	2.92	4.17	-	5.1	12.5	13.5	1210	4300	4800	19.6	18.7	17.9	
20+20+25+35+60		1.56	1.56	1.95	2.73	4.69	-	5.1	12.5	13.5	1210	4300	4800	19.6	18.7	17.9	
20+20+25+50+50		1.52	1.52	1.89	3.79	3.79	-	5.1	12.5	13.5	1210	4290	4800	19.5	18.7	17.9	
20+20+25+50+60		1.43	1.43	1.79	3.57	4.29	-	5.1	12.5	13.5	1210	4280	4800	19.5	18.6	17.9	
20+20+25+60+60		1.35	1.35	1.69	4.05	4.05	-	5.1	12.5	13.5	1210	4280	4800	19.5	18.6	17.9	
20+20+35+35+35		1.72	1.72	3.02	3.02	3.02	-	5.1	12.5	13.5	1210	4310	4800	19.6	18.8	18.0	
20+20+35+35+50		1.56	1.56	2.73	2.73	3.91	-	5.1	12.5	13.5	1210	4300	4800	19.6	18.7	17.9	
20+20+35+35+60		1.47	1.47	2.57	2.57	4.41	-	5.1	12.5	13.5	1210	4290	4800	19.5	18.7	17.9	
20+20+35+50+50		1.43	1.43	2.50	3.57	3.57	-	5.1	12.5	13.5	1210	4280	4800	19.5	18.6	17.9	
20+20+35+50+60		1.35	1.35	2.36	3.38	4.05	-	5.1	12.5	13.5	1210	4280	4800	19.5	18.6	17.9	
20+20+35+60+60		1.28	1.28	2.24	3.85	3.85	-	5.1	12.5	13.5	1210	4270	4800	19.4	18.6	17.8	
20+20+50+50+50		1.32	1.32	3.29	3.29	3.29	-	5.1	12.5	13.5	1210	4270	4800	19.4	18.6	17.8	
20+25+25+25+25		2.00	2.50	2.50	2.50	2.50	-	5.1	12.0	13.5	1210	3990	4800	18.2	17.4	16.6	
20+25+25+25+35		1.92	2.40	2.40	2.40	3.37	-	5.1	12.5	13.5	1210	4320	4800	19.7	18.8	18.0	
20+25+25+25+50		1.72	2.16	2.16	2.16	4.31	-	5.1	12.5	13.5	1210	4310	4800	19.6	18.8	18.0	
20+25+25+25+60		1.61	2.02	2.02	2.02	4.84	-	5.1	12.5	13.5	1210	4300	4800	19.6	18.7	17.9	
20+25+25+35+35		1.79	2.23	2.23	3.13	3.13	-	5.1	12.5	13.5	1210	4310	4800	19.6	18.8	18.0	
20+25+25+35+50		1.61	2.02	2.02	2.82	4.03	-	5.1	12.5	13.5	1210	4300	4800	19.6	18.7	17.9	
20+25+25+35+60		1.52	1.89	1.89	2.65	4.55	-	5.1	12.5	13.5	1210	4290	4800	19.5	18.7	17.9	
20+25+25+50+50		1.47	1.84	1.84	3.68	3.68	-	5.1	12.5	13.5	1210	4290	4800	19.5	18.7	17.9	
20+25+25+50+60	1.39	1.74	1.74	3.47	4.17	-	5.1	12.5	13.5	1210	4280	4800	19.5	18.6	17.9		
20+25+25+60+60	1.32	1.64	1.64	3.95	3.95	-	5.1	12.5	13.5	1210	4270	4800	19.4	18.6	17.8		
20+25+35+35+35	1.67	2.08	2.92	2.92	2.92	-	5.1	12.5	13.5	1210	4300	4800	19.6	18.7	17.9		
20+25+35+35+50	1.																



MULTI-SPLIT SYSTEM

Indoor unit combination		Cooling capacity (kW)									Power consumption(W)			Standard current(A)		
		Room cooling capacity						Total capacity			Min.	Standard	Max.	220V	230V	240V
		A	B	C	D	E	F	Min.	Standard	Max.						
5 room	20+35+35+35+50	1.43	2.50	2.50	2.50	3.57	-	5.1	12.5	13.5	1210	4280	4800	19.5	18.6	17.9
	20+35+35+35+60	1.35	2.36	2.36	2.36	4.05	-	5.1	12.5	13.5	1210	4280	4800	19.5	18.6	17.9
	20+35+35+50+50	1.32	2.30	2.30	3.29	3.29	-	5.1	12.5	13.5	1210	4270	4800	19.4	18.6	17.8
	25+25+25+25+25	2.50	2.50	2.50	2.50	2.50	-	5.1	12.5	13.5	1210	4330	4800	19.7	18.8	18.1
	25+25+25+25+35	2.31	2.31	2.31	2.31	3.24	-	5.1	12.5	13.5	1210	4320	4800	19.7	18.8	18.0
	25+25+25+25+50	2.08	2.08	2.08	2.08	4.17	-	5.1	12.5	13.5	1210	4300	4800	19.6	18.7	17.9
	25+25+25+25+60	1.95	1.95	1.95	1.95	4.69	-	5.1	12.5	13.5	1210	4300	4800	19.6	18.7	17.9
	25+25+25+35+35	2.16	2.16	2.16	3.02	3.02	-	5.1	12.5	13.5	1210	4310	4800	19.6	18.8	18.0
	25+25+25+35+50	1.95	1.95	1.95	2.73	3.91	-	5.1	12.5	13.5	1210	4300	4800	19.6	18.7	17.9
	25+25+25+35+60	1.84	1.84	1.84	2.57	4.41	-	5.1	12.5	13.5	1210	4290	4800	19.5	18.7	17.9
	25+25+25+50+50	1.79	1.79	1.79	3.57	3.57	-	5.1	12.5	13.5	1210	4280	4800	19.5	18.6	17.9
	25+25+25+50+60	1.69	1.69	1.69	3.38	4.05	-	5.1	12.5	13.5	1210	4280	4800	19.5	18.6	17.9
	25+25+25+60+60	1.60	1.60	1.60	3.85	3.85	-	5.1	12.5	13.5	1210	4270	4800	19.4	18.6	17.8
	25+25+35+35+35	2.02	2.02	2.82	2.82	2.82	-	5.1	12.5	13.5	1210	4300	4800	19.6	18.7	17.9
	25+25+35+35+50	1.84	1.84	2.57	2.57	3.68	-	5.1	12.5	13.5	1210	4290	4800	19.5	18.7	17.9
	25+25+35+35+60	1.74	1.74	2.43	2.43	4.17	-	5.1	12.5	13.5	1210	4280	4800	19.5	18.6	17.9
	25+25+35+50+50	1.69	1.69	2.36	3.38	3.38	-	5.1	12.5	13.5	1210	4280	4800	19.5	18.6	17.9
	25+25+35+50+60	1.60	1.60	2.24	3.21	3.85	-	5.1	12.5	13.5	1210	4270	4800	19.4	18.6	17.8
	25+35+35+35+35	1.89	2.65	2.65	2.65	2.65	-	5.1	12.5	13.5	1210	4290	4800	19.5	18.7	17.9
	25+35+35+35+50	1.74	2.43	2.43	2.43	3.47	-	5.1	12.5	13.5	1210	4280	4800	19.5	18.6	17.9
25+35+35+35+60	1.64	2.30	2.30	2.30	3.95	-	5.1	12.5	13.5	1210	4270	4800	19.4	18.6	17.8	
25+35+35+50+50	1.60	2.24	2.24	3.21	3.21	-	5.1	12.5	13.5	1210	4270	4800	19.4	18.6	17.8	
35+35+35+35+35	2.50	2.50	2.50	2.50	2.50	-	5.1	12.5	13.5	1210	4280	4800	19.5	18.6	17.9	
35+35+35+35+50	2.30	2.30	2.30	2.30	3.29	-	5.1	12.5	13.5	1210	4270	4800	19.4	18.6	17.8	
Cooling operation	20+20+20+20+20+20	2.00	2.00	2.00	2.00	2.00	2.00	5.5	12.0	13.8	1280	3660	4620	16.7	15.9	15.3
	20+20+20+20+20+25	2.00	2.00	2.00	2.00	2.00	2.50	5.5	12.5	14.0	1280	3900	4800	17.7	17.0	16.3
	20+20+20+20+20+35	1.85	1.85	1.85	1.85	1.85	3.24	5.5	12.5	14.0	1280	3890	4800	17.7	16.9	16.2
	20+20+20+20+20+50	1.67	1.67	1.67	1.67	1.67	4.17	5.5	12.5	14.0	1280	3860	4800	17.6	16.8	16.1
	20+20+20+20+20+60	1.56	1.56	1.56	1.56	1.56	4.69	5.5	12.5	14.0	1280	3860	4800	17.6	16.8	16.1
	20+20+20+20+25+25	1.92	1.92	1.92	1.92	2.40	2.40	5.5	12.5	14.0	1280	3900	4800	17.7	17.0	16.3
	20+20+20+20+25+35	1.79	1.79	1.79	1.79	2.23	3.13	5.5	12.5	14.0	1280	3880	4800	17.7	16.9	16.2
	20+20+20+20+25+50	1.61	1.61	1.61	1.61	2.02	4.03	5.5	12.5	14.0	1280	3860	4800	17.6	16.8	16.1
	20+20+20+20+25+60	1.52	1.52	1.52	1.52	1.89	4.55	5.5	12.5	14.0	1280	3850	4800	17.5	16.8	16.1
	20+20+20+20+35+35	1.67	1.67	1.67	1.67	2.92	2.92	5.5	12.5	14.0	1280	3860	4800	17.6	16.8	16.1
	20+20+20+20+35+50	1.52	1.52	1.52	1.52	2.65	3.79	5.5	12.5	14.0	1280	3850	4800	17.5	16.8	16.1
	20+20+20+20+35+60	1.43	1.43	1.43	1.43	2.50	4.29	5.5	12.5	14.0	1280	3830	4800	17.4	16.7	16.0
	20+20+20+20+50+50	1.39	1.39	1.39	1.39	3.47	3.47	5.5	12.5	14.0	1280	3820	4800	17.4	16.6	15.9
	20+20+20+20+50+60	1.32	1.32	1.32	1.32	3.29	3.95	5.5	12.5	14.0	1280	3800	4800	17.3	16.5	15.8
	20+20+20+25+25+25	1.85	1.85	1.85	2.31	2.31	2.31	5.5	12.5	14.0	1280	3890	4800	17.7	16.9	16.2
	20+20+20+25+25+35	1.72	1.72	1.72	2.16	2.16	3.02	5.5	12.5	14.0	1280	3870	4800	17.6	16.8	16.1
	20+20+20+25+25+50	1.56	1.56	1.56	1.95	1.95	3.91	5.5	12.5	14.0	1280	3860	4800	17.6	16.8	16.1
	20+20+20+25+25+60	1.47	1.47	1.47	1.84	1.84	4.41	5.5	12.5	14.0	1280	3840	4800	17.5	16.7	16.0
	20+20+20+25+35+35	1.61	1.61	1.61	2.02	2.82	2.82	5.5	12.5	14.0	1280	3860	4800	17.6	16.8	16.1
	20+20+20+25+35+50	1.47	1.47	1.47	1.84	2.57	3.68	5.5	12.5	14.0	1280	3840	4800	17.5	16.7	16.0
	20+20+20+25+35+60	1.39	1.39	1.39	1.74	2.43	4.17	5.5	12.5	14.0	1280	3820	4800	17.4	16.6	15.9
	20+20+20+25+50+50	1.35	1.35	1.35	1.69	3.38	3.38	5.5	12.5	14.0	1280	3810	4800	17.3	16.6	15.9
	20+20+20+25+50+60	1.28	1.28	1.28	1.60	3.21	3.85	5.5	12.5	14.0	1280	3800	4800	17.3	16.5	15.8
	20+20+20+35+35+35	1.52	1.52	1.52	2.65	2.65	2.65	5.5	12.5	14.0	1280	3850	4800	17.5	16.8	16.1
	20+20+20+35+35+50	1.39	1.39	1.39	2.43	2.43	3.47	5.5	12.5	14.0	1280	3820	4800	17.4	16.6	15.9
	20+20+20+35+35+60	1.32	1.32	1.32	2.30	2.30	3.95	5.5	12.5	14.0	1280	3800	4800	17.3	16.5	15.8
	20+20+20+35+50+50	1.28	1.28	1.28	2.24	3.21	3.21	5.5	12.5	14.0	1280	3800	4800	17.3	16.5	15.8
	20+20+25+25+25+25	1.79	1.79	2.23	2.23	2.23	2.23	5.5	12.5	14.0	1280	3880	4800	17.7	16.9	16.2
	20+20+25+25+25+35	1.67	1.67	2.08	2.08	2.08	2.92	5.5	12.5	14.0	1280	3860	4800	17.6	16.8	16.1
	20+20+25+25+25+50	1.52	1.52	1.89	1.89	1.89	3.79	5.5	12.5	14.0	1280	3850	4800	17.5	16.8	16.1
	20+20+25+25+25+60	1.43	1.43	1.79	1.79	1.79	4.29	5.5	12.5	14.0	1280	3830	4800	17.4	16.7	16.0
	20+20+25+25+35+35	1.56	1.56	1.95	1.95	2.73	2.73	5.5	12.5	14.0	1280	3860	4800	17.6	16.8	16.1
	20+20+25+25+35+50	1.43	1.43	1.79	1.79	2.50	3.57	5.5	12.5	14.0	1280	3830	4800	17.4	16.7	16.0
	20+20+25+25+35+60	1.35	1.35	1.69	1.69	2.36	4.05	5.5	12.5	14.0	1280	3810	4800	17.3	16.6	15.9
	20+20+25+25+50+50	1.32	1.32	1.64	1.64	3.29	3.29	5.5	12.5	14.0	1280	3800	4800	17.3	16.5	15.8
	20+20+25+25+35+35	1.47	1.47	1.84	2.57	2.57	2.57	5.5	12.5	14.0	1280	3840	4800	17.5	16.7	16.0
	20+20+25+25+35+50	1.35	1.35	1.69	2.36	2.36	3.38	5.5	12.5	14.0	1280	3810	4800	17.3	16.6	15.9
	20+20+25+25+35+60	1.28	1.28	1.60	2.24	2.24	3.85	5.5	12.5	14.0	1280	3800	4800	17.3	16.5	15.8
	20+20+35+35+35+35	1.39	1.39	2.43	2.43	2.43	2.43	5.5	12.5	14.0	1280	3820	4800	17.4	16.6	15.9
	20+20+35+35+35+50	1.28	1.28	2.24	2.24	2.24	3.21	5.5	12.5	14.0	1280	3800	4800	17.3	16.5	15.8
20+25+25+25+25+25	1.72	2.16	2.16	2.16	2.16	2.16	5.5	12.5	14.0	1280	3870	4800	17.6	16.8	16.1	
20+25+25+25+25+35	1.61	2.02	2.02	2.02	2.02	2.82	5.5	12.5	14.0	1280	3860	4800	17.6	16.8	16.1	
20+25+25+25+25+50	1.47	1.84	1.84	1.84	1.84	3.68	5.5	12.5	14.0	1280	3840	4800	17.5	16.7	16.0	
20+25+25+25+25+60	1.39	1.74	1.74	1.74	1.74	4.17	5.5	12.5	14.0	1280	3820	4800	17.4	16.6	15.9	

COMBINATIONS

Indoor unit combination		Cooling capacity (kW)									Power consumption(W)			Standard current(A)			
		Room cooling capacity						Total capacity			Min.	Standard	Max.	220V	230V	240V	
		A	B	C	D	E	F	Min.	Standard	Max.							
Cooling operation	6 room	25+25+25+25+25+35	1.95	1.95	1.95	1.95	1.95	2.73	5.5	12.5	14.0	1280	3860	4800	17.6	16.8	16.1
		25+25+25+25+25+50	1.79	1.79	1.79	1.79	1.79	3.57	5.5	12.5	14.0	1280	3830	4800	17.4	16.7	16.0
		25+25+25+25+25+60	1.69	1.69	1.69	1.69	1.69	4.05	5.5	12.5	14.0	1280	3810	4800	17.3	16.6	15.9
		25+25+25+25+35+35	1.84	1.84	1.84	1.84	2.57	2.57	5.5	12.5	14.0	1280	3840	4800	17.5	16.7	16.0
		25+25+25+25+35+50	1.69	1.69	1.69	1.69	2.36	3.38	5.5	12.5	14.0	1280	3810	4800	17.3	16.6	15.9
		25+25+25+25+35+60	1.60	1.60	1.60	1.60	2.24	3.85	5.5	12.5	14.0	1280	3800	4800	17.3	16.5	15.8
		25+25+25+35+35+35	1.74	1.74	1.74	2.43	2.43	2.43	5.5	12.5	14.0	1280	3820	4800	17.4	16.6	15.9
		25+25+25+35+35+50	1.60	1.60	1.60	2.24	2.24	3.21	5.5	12.5	14.0	1280	3800	4800	17.3	16.5	15.8
25+25+35+35+35+35	1.64	1.64	2.30	2.30	2.30	2.30	5.5	12.5	14.0	1280	3800	4800	17.3	16.5	15.8		

SCM125ZM-S Table of Indoor unit combination with other indoor unit

Indoor unit combination		Heating capacity (kW)									Power consumption(W)			Standard current(A)			
		Room heating capacity						Total capacity			Min.	Standard	Max.	220V	230V	240V	
		A	B	C	D	E	F	Min.	Standard	Max.							
Heating operation	1 room	20	3.0	-	-	-	-	-	1.5	3.0	3.6	700	1220	1330	5.6	5.4	5.1
		25	3.4	-	-	-	-	-	1.5	3.4	4.1	700	1265	1540	5.8	5.6	5.3
		35	4.5	-	-	-	-	-	1.5	4.5	4.9	700	1650	1840	7.6	7.2	6.9
		50	5.8	-	-	-	-	-	1.5	5.8	6.4	700	2120	2410	9.7	9.3	8.9
		60	6.8	-	-	-	-	-	1.5	6.8	7.4	700	2500	2760	11.5	11.0	10.5
		71	8.0	-	-	-	-	-	1.5	8.0	8.1	700	3020	3090	13.9	13.3	12.7
		20+20	3.00	3.00	-	-	-	-	2.1	6.0	7.2	750	1540	1860	7.1	6.8	6.5
	20+25	2.84	3.56	-	-	-	-	2.1	6.4	7.7	750	1660	2210	7.6	7.3	7.0	
	20+35	2.73	4.77	-	-	-	-	2.1	7.5	8.5	750	1990	2520	9.1	8.7	8.4	
	20+50	2.51	6.29	-	-	-	-	2.1	8.8	10.0	750	2430	3220	11.2	10.7	10.2	
	20+60	2.45	7.35	-	-	-	-	2.1	9.8	11.0	750	2840	3620	13.0	12.5	12.0	
	20+71	2.42	8.58	-	-	-	-	2.1	11.0	11.6	750	2840	3620	13.0	12.5	12.0	
	25+25	3.40	3.40	-	-	-	-	2.1	6.8	8.2	750	1770	2420	8.1	7.8	7.4	
	25+35	3.29	4.61	-	-	-	-	2.1	7.9	9.0	750	2140	2820	9.8	9.4	9.0	
	25+50	3.07	6.13	-	-	-	-	2.1	9.2	10.5	750	2630	3610	12.1	11.6	11.1	
	25+60	3.00	7.20	-	-	-	-	2.1	10.2	11.5	750	3040	3790	14.0	13.4	12.8	
	25+71	2.97	8.43	-	-	-	-	2.1	11.4	12.1	750	3440	4250	15.8	15.1	14.5	
	35+35	4.50	4.50	-	-	-	-	2.1	9.0	9.8	750	2520	3210	11.6	11.1	10.6	
	35+50	4.24	6.06	-	-	-	-	2.1	10.3	11.3	750	3040	3710	14.0	13.4	12.8	
	35+60	4.16	7.14	-	-	-	-	2.1	11.3	12.3	750	3420	4320	15.7	15.0	14.4	
	35+71	4.13	8.37	-	-	-	-	2.1	12.5	12.9	750	4030	4690	18.5	17.7	17.0	
	50+50	5.80	5.80	-	-	-	-	2.1	11.6	12.8	750	3660	4620	16.8	16.1	15.4	
	50+60	5.73	6.87	-	-	-	-	2.1	12.6	13.8	750	4090	5230	18.8	18.0	17.2	
	50+71	5.58	7.92	-	-	-	-	2.1	13.5	13.8	750	4540	5230	20.8	19.9	19.1	
	60+60	6.75	6.75	-	-	-	-	2.1	13.5	13.8	750	4540	5230	20.8	19.9	19.1	
	60+71	6.18	7.32	-	-	-	-	2.1	13.5	13.8	750	4540	5230	20.8	19.9	19.1	
	71+71	6.75	6.75	-	-	-	-	2.1	13.5	13.8	750	4530	5230	20.8	19.9	19.1	
	20+20+20	3.00	3.00	3.00	-	-	-	3.2	9.0	10.9	780	2270	3350	10.4	10.0	9.6	
20+20+25	2.89	2.89	3.62	-	-	-	3.2	9.4	11.4	780	2400	3550	11.0	10.5	10.1		
20+20+35	2.80	2.80	4.90	-	-	-	3.2	10.5	12.2	780	2760	3820	12.7	12.1	11.6		
20+20+50	2.62	2.62	6.56	-	-	-	3.2	11.8	13.7	780	3270	4290	15.0	14.4	13.8		
20+20+60	2.56	2.56	7.68	-	-	-	3.2	12.8	13.8	780	3690	4350	16.9	16.2	15.5		
20+20+71	2.43	2.43	8.64	-	-	-	3.2	13.5	13.8	780	4140	4350	19.0	18.2	17.4		
20+25+25	2.80	3.50	3.50	-	-	-	3.2	9.8	11.9	780	2560	3720	11.8	11.2	10.8		
20+25+35	2.73	3.41	4.77	-	-	-	3.2	10.9	12.7	780	2970	3990	13.6	13.0	12.5		
20+25+50	2.57	3.21	6.42	-	-	-	3.2	12.2	13.8	780	3480	4350	16.0	15.3	14.6		
20+25+60	2.51	3.14	7.54	-	-	-	3.2	13.2	13.8	780	3990	4350	18.3	17.5	16.8		
20+25+71	2.33	2.91	8.26	-	-	-	3.2	13.5	13.8	780	4140	4350	19.0	18.2	17.4		
20+35+35	2.67	4.67	4.67	-	-	-	3.2	12.0	13.5	780	3460	4220	15.9	15.2	14.6		
20+35+50	2.53	4.43	6.33	-	-	-	3.2	13.3	13.8	780	3980	4350	18.3	17.5	16.8		
20+35+60	2.35	4.11	7.04	-	-	-	3.2	13.5	13.8	780	4130	4350	19.0	18.1	17.4		
20+35+71	2.14	3.75	7.61	-	-	-	3.2	13.5	13.8	780	4130	4350	19.0	18.1	17.4		
20+50+50	2.25	5.63	5.63	-	-	-	3.2	13.5	13.8	780	4130	4350	19.0	18.1	17.4		
20+50+60	2.08	5.19	6.23	-	-	-	3.2	13.5	13.8	780	4130	4350	19.0	18.1	17.4		
20+50+71	1.91	4.79	6.80	-	-	-	4.2	13.5	13.8	780	4130	4350	18.8	18.0	17.2		
20+60+60	1.93	5.79	5.79	-	-	-	5.2	13.5	13.8	780	4130	4350	18.6	17.8	17.0		
20+60+71	1.79	5.36	6.35	-	-	-	6.2	13.5	13.8	780	4120	4350	18.4	17.6	16.8		
20+71+71	1.67	5.92	5.92	-	-	-	7.2	13.5	13.8	780	4120	4350	18.2	17.4	16.7		
25+25+25	3.40	3.40	3.40	-	-	-	3.2	10.2	12.4	780	2760	3880	12.7	12.1	11.6		
25+25+35	3.32	3.32	4.65	-	-	-	3.2	11.3	13.2	780	3170	4120	14.6	13.9	13.3		
25+25+50	3.15	3.15	6.30	-	-	-	3.2	12.6	13.8	780	3690	4350	16.9	16.2	15.5		
25+25+60	3.07	3.07	7.36	-	-	-	3.2	13.5	13.8	780	4130	4350	19.0	18.1	17.4		
25+25+71	2.79	2.79	7.92	-	-	-	3.2	13.5	13.8	780	4130	4350	19.0	18.1	17.4		
25+35+35	3.26	4.57	4.57	-	-	-	3.2	12.4	13.8	780	3780	4350	17.4	16.6	15.9		
25+35+50	3.07	4.30	6.14	-	-	-	3.2	13.5	13.8	780	4140	4350	19.0	18.2	17.4		
25+35+60	2.81	3.94	6.75	-	-	-	3.2	13.5	13.8	780	4140	4350	19.0	18.2	17.4		
25+35+71	2.58	3.61	7.32	-	-	-	4.2	13.5	13.8	780	4130	4350	18.8	18.0	17.2		
25+50+50	2.70	5.40	5.40	-	-	-	3.2	13.5	13.8	780	4130	4350	19.0	18.1	17.4		
25+50+60	2.50	5.00	6.00	-	-	-	3.2	13.5	13.8	780	4130	4350	19.0	18.1	17.4		
25+50+71	2.31	4.62	6.57	-	-	-	3.2	13.5	13.8	780	4130	4350	19.0	18.1	17.4		
25+60+60	2.33	5.59	5.59	-	-	-	3.2	13.5	13.8	780	4130	4350	19.0	18.1	17.4		



MULTI-SPLIT SYSTEM

Indoor unit combination		Heating capacity (kW)									Power consumption(W)			Standard current(A)			
		Room heating capacity						Total capacity			Min.	Standard	Max.	220V	230V	240V	
		A	B	C	D	E	F	Min.	Standard	Max.							
3 room	25+60+71	2.16	5.19	6.14	-	-	-	3.2	13.5	13.8	780	4120	4350	18.9	18.1	17.3	
	25+71+71	2.02	5.74	5.74	-	-	-	3.2	13.5	13.8	780	4120	4350	18.9	18.1	17.3	
	35+35+35	4.50	4.50	4.50	-	-	-	3.2	13.5	13.8	780	4140	4350	19.0	18.2	17.4	
	35+35+50	3.94	3.94	5.63	-	-	-	3.2	13.5	13.8	780	4140	4350	19.0	18.2	17.4	
	35+35+60	3.63	3.63	6.23	-	-	-	3.2	13.5	13.8	780	4130	4350	19.0	18.1	17.4	
	35+50+50	3.50	5.00	5.00	-	-	-	3.2	13.5	13.8	780	4130	4350	19.0	18.1	17.4	
	35+50+60	3.26	4.66	5.59	-	-	-	3.2	13.5	13.8	780	4130	4350	19.0	18.1	17.4	
	35+50+71	3.03	4.33	6.14	-	-	-	3.2	13.5	13.8	780	4120	4350	18.9	18.1	17.3	
	35+60+60	3.05	5.23	5.23	-	-	-	3.2	13.5	13.8	780	4120	4350	18.9	18.1	17.3	
	35+60+71	2.85	4.88	5.77	-	-	-	3.2	13.5	13.8	780	4120	4350	18.9	18.1	17.3	
	35+71+71	2.67	5.42	5.42	-	-	-	3.2	13.5	13.8	780	4120	4350	18.9	18.1	17.3	
	50+50+50	4.50	4.50	4.50	-	-	-	3.2	13.5	13.8	780	4120	4350	18.9	18.1	17.3	
	50+50+60	4.22	4.22	5.06	-	-	-	3.2	13.5	13.8	780	4120	4350	18.9	18.1	17.3	
	50+50+71	3.95	3.95	5.61	-	-	-	3.2	13.5	13.8	780	4120	4350	18.9	18.1	17.3	
	50+60+60	3.97	4.76	4.76	-	-	-	3.2	13.5	13.8	780	4120	4350	18.9	18.1	17.3	
	50+60+71	3.73	4.48	5.30	-	-	-	3.2	13.5	13.8	780	4110	4350	18.9	18.1	17.3	
	60+60+60	4.50	4.50	4.50	-	-	-	3.2	13.5	13.8	780	4110	4350	18.9	18.1	17.3	
	60+60+71	4.24	4.24	5.02	-	-	-	3.2	13.5	13.8	780	4110	4350	18.9	18.1	17.3	
	Heating operation	20+20+20+20	3.00	3.00	3.00	3.00	-	-	3.6	12.0	13.8	950	3270	3920	14.9	14.2	13.6
		20+20+20+25	2.92	2.92	2.92	3.65	-	-	3.6	12.4	13.8	950	3460	3920	15.7	15.1	14.4
20+20+20+35		2.84	2.84	2.84	4.97	-	-	3.6	13.5	13.8	950	3770	3920	17.2	16.4	15.7	
20+20+20+50		2.45	2.45	2.45	6.14	-	-	3.6	13.5	13.8	950	3760	3920	17.1	16.4	15.7	
20+20+20+60		2.25	2.25	2.25	6.75	-	-	3.6	13.5	13.8	950	3760	3920	17.1	16.4	15.7	
20+20+20+71		2.06	2.06	2.06	7.32	-	-	3.6	13.5	13.8	950	3750	3920	16.9	16.2	15.5	
20+20+25+25		2.84	2.84	3.56	3.56	-	-	3.6	12.8	13.8	950	3510	3920	16.0	15.3	14.6	
20+20+25+35		2.70	2.70	3.38	4.73	-	-	3.6	13.5	13.8	950	3770	3920	17.2	16.4	15.7	
20+20+25+50		2.35	2.35	2.93	5.87	-	-	3.6	13.5	13.8	950	3760	3920	17.1	16.4	15.7	
20+20+25+60		2.16	2.16	2.70	6.48	-	-	3.6	13.5	13.8	950	3750	3920	17.1	16.3	15.6	
20+20+25+71		1.99	1.99	2.48	7.05	-	-	3.6	13.5	13.8	950	3750	3920	17.1	16.3	15.6	
20+20+35+35		2.45	2.45	4.30	4.30	-	-	3.6	13.5	13.8	950	3760	3920	17.1	16.4	15.7	
20+20+35+50		2.16	2.16	3.78	5.40	-	-	3.6	13.5	13.8	950	3750	3920	17.1	16.3	15.6	
20+20+35+60		2.00	2.00	3.50	6.00	-	-	3.6	13.5	13.8	950	3750	3920	17.1	16.3	15.6	
20+20+35+71		1.85	1.85	3.24	6.57	-	-	3.6	13.5	13.8	950	3740	3920	17.0	16.3	15.6	
20+20+50+50		1.93	1.93	4.82	4.82	-	-	3.6	13.5	13.8	950	3740	3920	17.0	16.3	15.6	
20+20+50+60		1.80	1.80	4.50	5.40	-	-	3.6	13.5	13.8	950	3740	3920	17.0	16.3	15.6	
20+20+50+71		1.68	1.68	4.19	5.95	-	-	3.6	13.5	13.8	950	3740	3920	17.0	16.3	15.6	
20+20+60+60		1.69	1.69	5.06	5.06	-	-	3.6	13.5	13.8	950	3740	3920	17.0	16.3	15.6	
20+20+60+71		1.58	1.58	4.74	5.61	-	-	3.6	13.5	13.8	950	3730	3920	17.0	16.2	15.6	
20+20+71+71		1.48	1.48	5.27	5.27	-	-	3.6	13.5	13.8	950	3730	3920	17.0	16.2	15.6	
20+25+25+25		2.78	3.47	3.47	3.47	-	-	3.6	13.2	13.8	950	3620	3920	16.5	15.8	15.1	
20+25+25+35		2.57	3.21	3.21	4.50	-	-	3.6	13.5	13.8	950	3770	3920	17.2	16.4	15.7	
20+25+25+50		2.25	2.81	2.81	5.63	-	-	3.6	13.5	13.8	950	3760	3920	17.1	16.4	15.7	
20+25+25+60		2.08	2.60	2.60	6.23	-	-	3.6	13.5	13.8	950	3750	3920	17.1	16.3	15.6	
20+25+25+71		1.91	2.39	2.39	6.80	-	-	3.6	13.5	13.8	950	3740	3920	17.0	16.3	15.6	
20+25+35+35		2.35	2.93	4.11	4.11	-	-	3.6	13.5	13.8	950	3760	3920	17.1	16.4	15.7	
20+25+35+50		2.08	2.60	3.63	5.19	-	-	3.6	13.5	13.8	950	3750	3920	17.1	16.3	15.6	
20+25+35+60		1.93	2.41	3.38	5.79	-	-	3.6	13.5	13.8	950	3740	3920	17.0	16.3	15.6	
20+25+35+71		1.79	2.24	3.13	6.35	-	-	3.6	13.5	13.8	950	3740	3920	17.0	16.3	15.6	
20+25+50+50		1.86	2.33	4.66	4.66	-	-	3.6	13.5	13.8	950	3740	3920	17.0	16.3	15.6	
20+25+50+60		1.74	2.18	4.35	5.23	-	-	3.6	13.5	13.8	950	3740	3920	17.0	16.3	15.6	
20+25+50+71		1.63	2.03	4.07	5.77	-	-	3.6	13.5	13.8	950	3730	3920	17.0	16.2	15.6	
20+25+60+60		1.64	2.05	4.91	4.91	-	-	3.6	13.5	13.8	950	3730	3920	17.0	16.2	15.6	
20+25+60+71		1.53	1.92	4.60	5.45	-	-	3.6	13.5	13.8	950	3730	3920	17.0	16.2	15.6	
20+25+71+71		1.44	1.80	5.13	5.13	-	-	3.6	13.5	13.8	950	3720	3920	16.9	16.2	15.5	
20+35+35+35		2.16	3.78	3.78	3.78	-	-	3.6	13.5	13.8	950	3750	3920	17.1	16.3	15.6	
20+35+35+50		1.93	3.38	3.38	4.82	-	-	3.6	13.5	13.8	950	3740	3920	17.0	16.3	15.6	
20+35+35+60		1.80	3.15	3.15	5.40	-	-	3.6	13.5	13.8	950	3740	3920	17.0	16.3	15.6	
20+35+35+71		1.68	2.93	2.93	5.95	-	-	3.6	13.5	13.8	950	3740	3920	17.0	16.3	15.6	
20+35+50+50	1.74	3.05	4.35	4.35	-	-	3.6	13.5	13.8	950	3740	3920	17.0	16.3	15.6		
20+35+50+60	1.64	2.86	4.09	4.91	-	-	3.6	13.5	13.8	950	3730	3920	17.0	16.2	15.6		
20+35+50+71	1.53	2.68	3.84	5.45	-	-	3.6	13.5	13.8	950	3730	3920	17.0	16.2	15.6		
20+35+60+60	1.54	2.70	4.63	4.63	-	-	3.6	13.5	13.8	950	3730	3920	17.0	16.2	15.6		
20+35+60+71	1.45	2.54	4.35	5.15	-	-	3.6	13.5	13.8	950	3720	3920	16.9	16.2	15.5		
20+50+50+50	1.59	3.97	3.97	3.97	-	-	3.6	13.5	13.8	950	3730	3920	17.0	16.2	15.6		
20+50+50+60	1.50	3.75	3.75	4.50	-	-	3.6	13.5	13.8	950	3730	3920	17.0	16.2	15.6		
20+50+50+71	1.41	3.53	3.53	5.02	-	-	3.6	13.5	13.8	950	3720	3920	16.9	16.2	15.5		
20+50+60+60	1.42	3.55	4.26	4.26	-	-	3.6	13.5	13.8	950	3720	3920	16.9	16.2	15.5		
25+25+25+25	3.38	3.38	3.38	3.38	-	-	3.6	13.5	13.8	950	3770	3920	17.2	16.4	15.7		
25+25+25+35	3.07	3.07	3.07	4.30	-	-	3.6	13.5	13.8	950	3760	3920	17.1	16.4	15.7		
25+25+25+50	2.70	2.70	2.70	5.40	-	-	3.6	13.5	13.8	950	3750	3920	17.1	16.3	15.6		
25+25+25+60	2.50	2.50	2.50	6.00	-	-	3.6	13.5	13.8	950	3750	3920	17.1	16.3	15.6		
25+25+25+71	2.31	2.31	2.31	6.57	-	-	3.6	13.5	13.8	950	3740	3920	17.0	16.3	15.6		
25+25+35+35	2.81	2.81	3.94	3.94	-	-	3.6	13.5	13.8	950	3760	3920	17.1	16.4	15.7		
25+25+35+50	2.50	2.50	3.50	5.00	-	-	3.6	13.5	13.8	950	3750	3920	17.1	16.3	15.6		

COMBINATIONS

Indoor unit combination		Heating capacity (kW)									Power consumption(W)			Standard current(A)			
		Room heating capacity						Total capacity			Min.	Standard	Max.	220V	230V	240V	
		A	B	C	D	E	F	Min.	Standard	Max.							
4 room	25+25+50+50	2.25	2.25	4.50	4.50	-	-	3.6	13.5	13.8	950	3740	3920	17.0	16.3	15.6	
	25+25+50+60	2.11	2.11	4.22	5.06	-	-	3.6	13.5	13.8	950	3740	3920	17.0	16.3	15.6	
	25+25+50+71	1.97	1.97	3.95	5.61	-	-	3.6	13.5	13.8	950	3730	3920	17.0	16.2	15.6	
	25+25+60+60	1.99	1.99	4.76	4.76	-	-	3.6	13.5	13.8	950	3730	3920	17.0	16.2	15.6	
	25+25+60+71	1.86	1.86	4.48	5.30	-	-	3.6	13.5	13.8	950	3730	3920	17.0	16.2	15.6	
	25+25+71+71	1.76	1.76	4.99	4.99	-	-	3.6	13.5	13.8	950	3720	3920	16.9	16.2	15.5	
	25+35+35+35	2.60	3.63	3.63	3.63	-	-	3.6	13.5	13.8	950	3750	3920	17.1	16.3	15.6	
	25+35+35+50	2.33	3.26	3.26	4.66	-	-	3.6	13.5	13.8	950	3740	3920	17.0	16.3	15.6	
	25+35+35+60	2.18	3.05	3.05	5.23	-	-	3.6	13.5	13.8	950	3740	3920	17.0	16.3	15.6	
	25+35+35+71	2.03	2.85	2.85	5.77	-	-	3.6	13.5	13.8	950	3730	3920	17.0	16.2	15.6	
	25+35+50+50	2.11	2.95	4.22	4.22	-	-	3.6	13.5	13.8	950	3740	3920	17.0	16.3	15.6	
	25+35+50+60	1.99	2.78	3.97	4.76	-	-	3.6	13.5	13.8	950	3730	3920	17.0	16.2	15.6	
	25+35+50+71	1.86	2.61	3.73	5.30	-	-	3.6	13.5	13.8	950	3730	3920	17.0	16.2	15.6	
	25+35+60+60	1.88	2.63	4.50	5.00	-	-	3.6	13.5	13.8	950	3730	3920	17.0	16.2	15.6	
	25+35+60+71	1.77	2.47	4.24	5.02	-	-	3.6	13.5	13.8	950	3720	3920	16.9	16.2	15.5	
	25+50+50+50	1.93	3.86	3.86	3.86	-	-	3.6	13.5	13.8	950	3730	3920	17.0	16.2	15.6	
	25+50+50+60	1.82	3.65	3.65	4.38	-	-	3.6	13.5	13.8	950	3720	3920	16.9	16.2	15.5	
	25+50+60+60	1.73	3.46	4.15	4.15	-	-	3.6	13.5	13.8	950	3720	3920	16.9	16.2	15.5	
	35+35+35+35	3.38	3.38	3.38	3.38	-	-	3.6	13.5	13.8	950	3740	3920	17.0	16.3	15.6	
	35+35+35+50	3.05	3.05	3.05	4.35	-	-	3.6	13.5	13.8	950	3740	3920	17.0	16.3	15.6	
	35+35+35+60	2.86	2.86	2.86	4.91	-	-	3.6	13.5	13.8	950	3730	3920	17.0	16.2	15.6	
	35+35+35+71	2.68	2.68	2.68	5.45	-	-	3.6	13.5	13.8	950	3730	3920	17.0	16.2	15.6	
	35+35+50+50	2.78	2.78	3.97	3.97	-	-	3.6	13.5	13.8	950	3730	3920	17.0	16.2	15.6	
	35+35+50+60	2.63	2.63	3.75	4.50	-	-	3.6	13.5	13.8	950	3730	3920	17.0	16.2	15.6	
	35+35+50+71	2.47	2.47	3.53	5.02	-	-	3.6	13.5	13.8	950	3720	3920	16.9	16.2	15.5	
	35+35+60+60	2.49	2.49	4.26	4.26	-	-	3.6	13.5	13.8	950	3720	3920	16.9	16.2	15.5	
	35+50+50+50	2.55	3.65	3.65	3.65	-	-	3.6	13.5	13.8	950	3720	3920	16.9	16.2	15.5	
	35+50+50+60	2.42	3.46	3.46	4.15	-	-	3.6	13.5	13.8	950	3720	3920	16.9	16.2	15.5	
	5 room	20+20+20+20+20	2.70	2.70	2.70	2.70	2.70	-	4.0	13.5	13.8	1050	3450	3470	15.7	15.0	14.4
		20+20+20+20+25	2.57	2.57	2.57	2.57	3.21	-	4.0	13.5	13.8	1050	3450	3470	15.7	15.0	14.4
		20+20+20+20+35	2.35	2.35	2.35	2.35	4.11	-	4.0	13.5	13.8	1050	3440	3470	15.7	15.0	14.3
		20+20+20+20+50	2.08	2.08	2.08	2.08	5.19	-	4.0	13.5	13.8	1050	3430	3470	15.6	14.9	14.3
		20+20+20+20+60	1.93	1.93	1.93	1.93	5.79	-	4.0	13.5	13.8	1050	3430	3470	15.6	14.9	14.3
		20+20+20+20+71	1.79	1.79	1.79	1.79	6.35	-	4.0	13.5	13.8	1050	3420	3470	15.6	14.9	14.3
		20+20+20+25+25	2.45	2.45	2.45	3.07	3.07	-	4.0	13.5	13.8	1050	3450	3470	15.7	15.0	14.4
20+20+20+25+35		2.25	2.25	2.25	2.81	3.94	-	4.0	13.5	13.8	1050	3440	3470	15.7	15.0	14.3	
20+20+20+25+50		2.00	2.00	2.00	2.50	5.00	-	4.0	13.5	13.8	1050	3430	3470	15.6	14.9	14.3	
20+20+20+25+60		1.86	1.86	1.86	2.33	5.59	-	4.0	13.5	13.8	1050	3420	3470	15.6	14.9	14.3	
20+20+20+25+71		1.73	1.73	1.73	2.16	6.14	-	4.0	13.5	13.8	1050	3420	3470	15.6	14.9	14.3	
20+20+20+35+35		2.08	2.08	2.08	3.63	3.63	-	4.0	13.5	13.8	1050	3430	3470	15.6	14.9	14.3	
20+20+20+35+50		1.86	1.86	1.86	3.26	4.66	-	4.0	13.5	13.8	1050	3420	3470	15.6	14.9	14.3	
20+20+20+35+60		1.74	1.74	1.74	3.05	5.23	-	4.0	13.5	13.8	1050	3420	3470	15.6	14.9	14.3	
20+20+20+35+71		1.63	1.63	1.63	2.85	5.77	-	4.0	13.5	13.8	1050	3410	3470	15.5	14.8	14.2	
20+20+20+50+50		1.69	1.69	1.69	4.22	4.22	-	4.0	13.5	13.8	1050	3410	3470	15.5	14.8	14.2	
20+20+20+50+60		1.59	1.59	1.59	3.97	4.76	-	4.0	13.5	13.8	1050	3410	3470	15.5	14.8	14.2	
20+20+20+50+60		1.50	1.50	1.50	4.50	4.50	-	4.0	13.5	13.8	1050	3400	3470	15.5	14.8	14.2	
20+20+20+50+71		1.41	1.41	1.41	4.24	5.02	-	4.0	13.5	13.8	1050	3390	3470	15.4	14.8	14.1	
20+20+25+25+25		2.35	2.35	2.93	2.93	2.93	-	4.0	13.5	13.8	1050	3440	3470	15.7	15.0	14.3	
20+20+25+25+35		2.16	2.16	2.70	2.70	3.78	-	4.0	13.5	13.8	1050	3440	3470	15.7	15.0	14.3	
20+20+25+25+50		1.93	1.93	2.41	2.41	4.82	-	4.0	13.5	13.8	1050	3430	3470	15.6	14.9	14.3	
20+20+25+25+60		1.80	1.80	2.25	2.25	5.40	-	4.0	13.5	13.8	1050	3420	3470	15.6	14.9	14.3	
20+20+25+25+71		1.68	1.68	2.10	2.10	5.95	-	4.0	13.5	13.8	1050	3410	3470	15.5	14.8	14.2	
20+20+25+35+35		2.00	2.00	2.50	3.50	3.50	-	4.0	13.5	13.8	1050	3430	3470	15.6	14.9	14.3	
20+20+25+35+50		1.80	1.80	2.25	3.15	4.50	-	4.0	13.5	13.8	1050	3420	3470	15.6	14.9	14.3	
20+20+25+35+60		1.69	1.69	2.11	2.95	5.06	-	4.0	13.5	13.8	1050	3410	3470	15.5	14.8	14.2	
20+20+25+35+71		1.58	1.58	1.97	2.76	5.61	-	4.0	13.5	13.8	1050	3410	3470	15.5	14.8	14.2	
20+20+25+50+50		1.64	1.64	2.05	4.09	4.09	-	4.0	13.5	13.8	1050	3410	3470	15.5	14.8	14.2	
20+20+25+50+60		1.54	1.54	1.93	3.86	4.63	-	4.0	13.5	13.8	1050	3410	3470	15.5	14.8	14.2	
20+20+25+50+71		1.45	1.45	1.81	3.63	5.15	-	4.0	13.5	13.8	1050	3400	3470	15.5	14.8	14.2	
20+20+25+60+60		1.46	1.46	1.82	4.38	4.38	-	4.0	13.5	13.8	1050	3400	3470	15.5	14.8	14.2	
20+20+35+35+35		1.86	1.86	3.26	3.26	3.26	-	4.0	13.5	13.8	1050	3420	3470	15.6	14.9	14.3	
20+20+35+35+50		1.69	1.69	2.95	2.95	4.22	-	4.0	13.5	13.8	1050	3410	3470	15.5	14.8	14.2	
20+20+35+35+60		1.59	1.59	2.78	2.78	4.76	-	4.0	13.5	13.8	1050	3410	3470	15.5	14.8	14.2	
20+20+35+35+71	1.49	1.49	2.61	2.61	5.30	-	4.0	13.5	13.8	1050	3400	3470	15.5	14.8	14.2		
20+20+35+50+50	1.54	1.54	2.70	3.86	3.86	-	4.0	13.5	13.8	1050	3410	3470	15.5	14.8	14.2		
20+20+35+50+60	1.46	1.46	2.55	3.65	4.38	-	4.0	13.5	13.8	1050	3400	3470	15.5	14.8	14.2		
20+20+35+60+60	1.38	1.38	2.42	4.15	4.15	-	4.0	13.5	13.8	1050	3390	3470	15.4	14.8	14.1		
20+20+50+50+50	1.42	1.42	3.55	3.55	3.55	-	4.0	13.5	13.8	1050	3390	3470	15.4	14.8	14.1		
20+25+25+25+25	2.25	2.81	2.81	2.81	2.81	-	4.0	13.5	13.8	1050	3440	3470	15.7	15.0	14.3		
20+25+25+25+35	2.08	2.60	2.60	2.60	3.63	-	4.0	13.5	13.8	1050	3430	3470	15.6	14.9	14.3		
20+25+25+25+50	1.86	2.33	2.33	2.33	4.66	-	4.0	13.5	13.8	1050	3420	3470	15.6	14.9	14.3		
20+25+25+25+60	1.74	2.18	2.18	2.18	5.23	-	4.0	13.5	13.8	1050	3420	3470	15.6	14.9	14.3		
20+25+25+25+71	1.63	2.03	2.03	2.03	5.77	-	4.0	13.5	13.8	1050	3410	3470	15.5	14.8	14.2		
20+25+25+35+35	1.93	2.41	2.41	3.38	3.38	-	4.0	13.5	13.8	1050	3430	3470	15.6	14.9	14.3		
20+25+25+35+50	1.74	2.18	2.18	3.05	4.35	-	4.0	13.5	13.8	1050	3420	3470	15.6	14.9	14.3		
20+25+25+35+60	1.64	2.05	2.05	2.86	4.91	-	4.0	13.5	13.8	1050	3410	3470	15.5	14.8	14.2		
20+25+25+35+71	1.53	1.92	1.92	2.68	5.45	-	4.0	13.5	13.8	1050	3410	3470	15.5	14.8	14.2		



MULTI-SPLIT SYSTEM

Indoor unit combination		Heating capacity (kW)									Power consumption(W)			Standard current(A)			
		Room heating capacity						Total capacity			Min.	Standard	Max.	220V	230V	240V	
		A	B	C	D	E	F	Min.	Standard	Max.							
Heating operation	5 room	20+25+25+50+50	1.59	1.99	1.99	3.97	3.97	-	4.0	13.5	13.8	1050	3410	3470	15.5	14.8	14.2
		20+25+25+50+60	1.50	1.88	1.88	3.75	4.50	-	4.0	13.5	13.8	1050	3400	3470	15.5	14.8	14.2
		20+25+25+50+71	1.41	1.77	1.77	3.53	5.02	-	4.0	13.5	13.8	1050	3390	3470	15.4	14.8	14.1
		20+25+25+60+60	1.42	1.78	1.78	4.26	4.26	-	4.0	13.5	13.8	1050	3390	3470	15.4	14.8	14.1
		20+25+35+35+35	1.80	2.25	3.15	3.15	3.15	-	4.0	13.5	13.8	1050	3420	3470	15.6	14.9	14.3
		20+25+35+35+50	1.64	2.05	2.86	2.86	4.09	-	4.0	13.5	13.8	1050	3410	3470	15.5	14.8	14.2
		20+25+35+35+60	1.54	1.93	2.70	2.70	4.63	-	4.0	13.5	13.8	1050	3410	3470	15.5	14.8	14.2
		20+25+35+35+71	1.45	1.81	2.54	2.54	5.15	-	4.0	13.5	13.8	1050	3400	3470	15.5	14.8	14.2
		20+25+35+50+50	1.50	1.88	2.63	3.75	3.75	-	4.0	13.5	13.8	1050	3400	3470	15.5	14.8	14.2
		20+25+35+50+60	1.42	1.78	2.49	3.55	4.26	-	4.0	13.5	13.8	1050	3390	3470	15.4	14.8	14.1
		20+25+50+50+50	1.38	1.73	3.46	3.46	3.46	-	4.0	13.5	13.8	1050	3390	3470	15.4	14.8	14.1
		20+35+35+35+35	1.69	2.95	2.95	2.95	2.95	-	4.0	13.5	13.8	1050	3410	3470	15.5	14.8	14.2
		20+35+35+35+50	1.54	2.70	2.70	2.70	3.86	-	4.0	13.5	13.8	1050	3410	3470	15.5	14.8	14.2
		20+35+35+35+60	1.46	2.55	2.55	2.55	4.38	-	4.0	13.5	13.8	1050	3400	3470	15.5	14.8	14.2
		20+35+35+50+50	1.42	2.49	2.49	3.55	3.55	-	4.0	13.5	13.8	1050	3390	3470	15.4	14.8	14.1
		25+25+25+25+25	2.70	2.70	2.70	2.70	2.70	-	4.0	13.5	13.8	1050	3440	3470	15.7	15.0	14.3
		25+25+25+25+35	2.50	2.50	2.50	2.50	3.50	-	4.0	13.5	13.8	1050	3430	3470	15.6	14.9	14.3
		25+25+25+25+50	2.25	2.25	2.25	2.25	4.50	-	4.0	13.5	13.8	1050	3420	3470	15.6	14.9	14.3
		25+25+25+25+60	2.11	2.11	2.11	2.11	5.06	-	4.0	13.5	13.8	1050	3410	3470	15.5	14.8	14.2
		25+25+25+25+71	1.97	1.97	1.97	1.97	5.61	-	4.0	13.5	13.8	1050	3410	3470	15.5	14.8	14.2
		25+25+25+35+35	2.33	2.33	2.33	3.26	3.26	-	4.0	13.5	13.8	1050	3420	3470	15.6	14.9	14.3
		25+25+25+35+50	2.11	2.11	2.11	2.95	4.22	-	4.0	13.5	13.8	1050	3410	3470	15.5	14.8	14.2
		25+25+25+35+60	1.99	1.99	1.99	2.78	4.76	-	4.0	13.5	13.8	1050	3410	3470	15.5	14.8	14.2
		25+25+25+35+71	1.86	1.86	1.86	2.61	5.30	-	4.0	13.5	13.8	1050	3400	3470	15.5	14.8	14.2
		25+25+25+50+50	1.93	1.93	1.93	3.86	3.86	-	4.0	13.5	13.8	1050	3410	3470	15.5	14.8	14.2
		25+25+25+50+60	1.82	1.82	1.82	3.65	4.38	-	4.0	13.5	13.8	1050	3400	3470	15.5	14.8	14.2
		25+25+25+60+60	1.73	1.73	1.73	4.15	4.15	-	4.0	13.5	13.8	1050	3390	3470	15.4	14.8	14.1
		25+25+35+35+35	2.18	2.18	3.05	3.05	3.05	-	4.0	13.5	13.8	1050	3420	3470	15.6	14.9	14.3
		25+25+35+35+50	1.99	1.99	2.78	2.78	3.97	-	4.0	13.5	13.8	1050	3410	3470	15.5	14.8	14.2
		25+25+35+35+60	1.88	1.88	2.63	2.63	4.50	-	4.0	13.5	13.8	1050	3400	3470	15.5	14.8	14.2
		25+25+35+35+71	1.77	1.77	2.47	2.47	5.02	-	4.0	13.5	13.8	1050	3390	3470	15.4	14.8	14.1
		25+25+35+50+50	1.82	1.82	2.55	3.65	3.65	-	4.0	13.5	13.8	1050	3400	3470	15.5	14.8	14.2
		25+25+35+50+60	1.73	1.73	2.42	3.46	4.15	-	4.0	13.5	13.8	1050	3390	3470	15.4	14.8	14.1
		25+35+35+35+35	2.05	2.86	2.86	2.86	2.86	-	4.0	13.5	13.8	1050	3410	3470	15.5	14.8	14.2
		25+35+35+35+50	1.88	2.63	2.63	2.63	3.75	-	4.0	13.5	13.8	1050	3400	3470	15.5	14.8	14.2
25+35+35+35+60	1.78	2.49	2.49	2.49	4.26	-	4.0	13.5	13.8	1050	3390	3470	15.4	14.8	14.1		
25+35+35+50+50	1.73	2.42	2.42	3.46	3.46	-	4.0	13.5	13.8	1050	3390	3470	15.4	14.8	14.1		
35+35+35+35+35	2.70	2.70	2.70	2.70	2.70	-	4.0	13.5	13.8	1050	3410	3470	15.5	14.8	14.2		
35+35+35+35+50	2.49	2.49	2.49	2.49	3.55	-	4.0	13.5	13.8	1050	3390	3470	15.4	14.8	14.1		
20+20+20+20+20+20	2.25	2.25	2.25	2.25	2.25	2.25	4.5	13.5	13.8	1150	3330	3420	15.2	14.5	13.9		
20+20+20+20+20+25	2.16	2.16	2.16	2.16	2.16	2.70	4.5	13.5	13.8	1150	3330	3420	15.2	14.5	13.9		
20+20+20+20+20+35	2.00	2.00	2.00	2.00	2.00	3.50	4.5	13.5	13.8	1150	3330	3420	15.2	14.5	13.9		
20+20+20+20+20+50	1.80	1.80	1.80	1.80	1.80	4.50	4.5	13.5	13.8	1150	3320	3420	15.1	14.4	13.8		
20+20+20+20+20+60	1.69	1.69	1.69	1.69	1.69	5.06	4.5	13.5	13.8	1150	3320	3420	15.1	14.4	13.8		
20+20+20+20+20+71	1.58	1.58	1.58	1.58	1.58	5.61	4.5	13.5	13.8	1150	3310	3420	15.1	14.4	13.8		
20+20+20+20+25+25	2.08	2.08	2.08	2.08	2.60	2.60	4.5	13.5	13.8	1150	3330	3420	15.2	14.5	13.9		
20+20+20+20+25+35	1.93	1.93	1.93	1.93	2.41	3.38	4.5	13.5	13.8	1150	3320	3420	15.1	14.4	13.8		
20+20+20+20+25+50	1.74	1.74	1.74	1.74	2.18	4.35	4.5	13.5	13.8	1150	3320	3420	15.1	14.4	13.8		
20+20+20+20+25+60	1.64	1.64	1.64	1.64	2.05	4.91	4.5	13.5	13.8	1150	3320	3420	15.1	14.4	13.8		
20+20+20+20+25+71	1.53	1.53	1.53	1.53	1.92	5.45	4.5	13.5	13.8	1150	3310	3420	15.1	14.4	13.8		
20+20+20+20+35+35	1.80	1.80	1.80	1.80	3.15	3.15	4.5	13.5	13.8	1150	3320	3420	15.1	14.4	13.8		
20+20+20+20+35+50	1.64	1.64	1.64	1.64	2.86	4.09	4.5	13.5	13.8	1150	3320	3420	15.1	14.4	13.8		
20+20+20+20+35+60	1.54	1.54	1.54	1.54	2.70	4.63	4.5	13.5	13.8	1150	3310	3420	15.1	14.4	13.8		
20+20+20+20+35+71	1.45	1.45	1.45	1.45	2.54	5.15	4.5	13.5	13.8	1150	3310	3420	15.1	14.4	13.8		
20+20+20+20+50+50	1.50	1.50	1.50	1.50	3.75	3.75	4.5	13.5	13.8	1150	3310	3420	15.1	14.4	13.8		
20+20+20+20+50+60	1.42	1.42	1.42	1.42	3.55	4.26	4.5	13.5	13.8	1150	3310	3420	15.1	14.4	13.8		
20+20+20+25+25+25	2.00	2.00	2.00	2.50	2.50	2.50	4.5	13.5	13.8	1150	3330	3420	15.2	14.5	13.9		
20+20+20+25+25+35	1.86	1.86	1.86	2.33	2.33	3.26	4.5	13.5	13.8	1150	3320	3420	15.1	14.4	13.8		
20+20+20+25+25+50	1.69	1.69	1.69	2.11	2.11	4.22	4.5	13.5	13.8	1150	3320	3420	15.1	14.4	13.8		
20+20+20+25+25+60	1.59	1.59	1.59	1.99	1.99	4.76	4.5	13.5	13.8	1150	3310	3420	15.1	14.4	13.8		
20+20+20+25+25+71	1.49	1.49	1.49	1.86	1.86	5.30	4.5	13.5	13.8	1150	3310	3420	15.1	14.4	13.8		
20+20+20+25+35+35	1.74	1.74	1.74	2.18	3.05	3.05	4.5	13.5	13.8	1150	3320	3420	15.1	14.4	13.8		
20+20+20+25+35+50	1.59	1.59	1.59	1.99	2.78	3.97	4.5	13.5	13.8	1150	3310	3420	15.1	14.4	13.8		
20+20+20+25+35+60	1.50	1.50	1.50	1.88	2.63	4.50	4.5	13.5	13.8	1150	3310	3420	15.1	14.4	13.8		
20+20+20+25+50+50	1.46	1.46	1.46	1.82	3.65	3.65	4.5	13.5	13.8	1150	3310	3420	15.1	14.4	13.8		
20+20+20+25+50+60	1.38	1.38	1.38	1.73	3.46	4.15	4.5	13.5	13.8	1150	3310	3420	15.1	14.4	13.8		
20+20+20+35+35+35	1.64	1.64	1.64	2.86	2.86	2.86	4.5	13.5	13.8	1150	3320	3420	15.1	14.4	13.8		
20+20+20+35+35+50	1.50	1.50	1.50	2.63	2.63	3.75	4.5	13.5	13.8	1150	3310	3420	15.1	14.4	13.8		
20+20+20+35+35+60	1.42	1.42	1.42	2.49	2.49	4.26	4.5	13.5	13.8	1150	3310	3420	15.1	14.4	13.8		
20+20+20+35+50+50	1.38	1.38	1.38	2.42	3.46	3.46	4.5	13.5	13.8	1150	3310	3420	15.1	14.4	13.8		
20+20+25+25+25+25	1.93	1.93	2.41	2.41	2.41	2.41	4.5	13.5	13.8	1150	3320	3420	15.1	14.4	13.8		
20+20+25+25+25+35	1.80	1.80	2.25	2.25	2.25	3.15	4.5	13.5	13.8	1150	3320	3420	15.1	14.4	13.8		
20+20+25+25+25+50	1.64	1.64	2.05	2.05	2.05	4.09	4.5	13.5	13.8	1150	3320	3420	15.1	14.4	13.8		
20+20+25+25+25+60	1.54	1.54	1.93	1.93	1.93	4.63	4.5	13.5	13.8	1150	3310	3420	15.1	14.4	13.8		
20+20+25+25+25+71	1.45	1.45	1.81	1.81	1.81	5.15	4.5	13.5	13.8	1150	3310	3420	15.1</				

COMBINATIONS

Indoor unit combination		Heating capacity (kW)									Power consumption(W)			Standard current(A)			
		Room heating capacity						Total capacity			Min.	Standard	Max.	220V	230V	240V	
		A	B	C	D	E	F	Min.	Standard	Max.							
Heating operation	6 room	20+20+25+25+35+60	1.46	1.46	1.82	1.82	2.55	4.38	4.5	13.5	13.8	1150	3310	3420	15.1	14.4	13.8
		20+20+25+25+50+50	1.42	1.42	1.78	1.78	3.55	3.55	4.5	13.5	13.8	1150	3310	3420	15.1	14.4	13.8
		20+20+25+35+35+35	1.59	1.59	1.99	2.78	2.78	2.78	4.5	13.5	13.8	1150	3310	3420	15.1	14.4	13.8
		20+20+25+35+35+50	1.46	1.46	1.82	2.55	2.55	3.65	4.5	13.5	13.8	1150	3310	3420	15.1	14.4	13.8
		20+20+25+35+35+60	1.38	1.38	1.73	2.42	2.42	4.15	4.5	13.5	13.8	1150	3310	3420	15.1	14.4	13.8
		20+20+35+35+35+35	1.50	1.50	2.63	2.63	2.63	2.63	4.5	13.5	13.8	1150	3310	3420	15.1	14.4	13.8
		20+20+35+35+35+50	1.38	1.38	2.42	2.42	2.42	3.46	4.5	13.5	13.8	1150	3310	3420	15.1	14.4	13.8
		20+25+25+25+25+25	1.86	2.33	2.33	2.33	2.33	2.33	4.5	13.5	13.8	1150	3320	3420	15.1	14.4	13.8
		20+25+25+25+25+35	1.74	2.18	2.18	2.18	2.18	3.05	4.5	13.5	13.8	1150	3320	3420	15.1	14.4	13.8
		20+25+25+25+25+50	1.59	1.99	1.99	1.99	1.99	3.97	4.5	13.5	13.8	1150	3310	3420	15.1	14.4	13.8
		20+25+25+25+25+60	1.50	1.88	1.88	1.88	1.88	4.50	4.5	13.5	13.8	1150	3310	3420	15.1	14.4	13.8
		20+25+25+25+25+71	1.41	1.77	1.77	1.77	1.77	5.02	4.5	13.5	13.8	1150	3310	3420	15.1	14.4	13.8
		20+25+25+25+35+35	1.64	2.05	2.05	2.05	2.86	2.86	4.5	13.5	13.8	1150	3320	3420	15.1	14.4	13.8
		20+25+25+25+35+50	1.50	1.88	1.88	1.88	2.63	3.75	4.5	13.5	13.8	1150	3310	3420	15.1	14.4	13.8
		20+25+25+25+35+60	1.42	1.78	1.78	1.78	2.49	4.26	4.5	13.5	13.8	1150	3310	3420	15.1	14.4	13.8
		20+25+25+25+50+50	1.38	1.73	1.73	1.73	3.46	3.46	4.5	13.5	13.8	1150	3310	3420	15.1	14.4	13.8
		20+25+25+35+35+35	1.54	1.93	1.93	2.70	2.70	2.70	4.5	13.5	13.8	1150	3310	3420	15.1	14.4	13.8
		20+25+25+35+35+50	1.42	1.78	1.78	2.49	2.49	3.55	4.5	13.5	13.8	1150	3310	3420	15.1	14.4	13.8
		20+25+35+35+35+35	1.46	1.82	2.55	2.55	2.55	2.55	4.5	13.5	13.8	1150	3310	3420	15.1	14.4	13.8
		20+35+35+35+35+35	1.38	2.42	2.42	2.42	2.42	2.42	4.5	13.5	13.8	1150	3310	3420	15.1	14.4	13.8
		25+25+25+25+25+25	2.25	2.25	2.25	2.25	2.25	2.25	4.5	13.5	13.8	1150	3320	3420	15.1	14.4	13.8
		25+25+25+25+25+35	2.11	2.11	2.11	2.11	2.11	2.95	4.5	13.5	13.8	1150	3320	3420	15.1	14.4	13.8
		25+25+25+25+25+50	1.93	1.93	1.93	1.93	3.86	3.86	4.5	13.5	13.8	1150	3310	3420	15.1	14.4	13.8
		25+25+25+25+25+60	1.82	1.82	1.82	1.82	4.38	4.38	4.5	13.5	13.8	1150	3310	3420	15.1	14.4	13.8
		25+25+25+25+35+35	1.99	1.99	1.99	1.99	2.78	2.78	4.5	13.5	13.8	1150	3310	3420	15.1	14.4	13.8
		25+25+25+25+35+50	1.82	1.82	1.82	1.82	2.55	3.65	4.5	13.5	13.8	1150	3310	3420	15.1	14.4	13.8
		25+25+25+25+35+60	1.73	1.73	1.73	1.73	2.42	4.15	4.5	13.5	13.8	1150	3310	3420	15.1	14.4	13.8
		25+25+25+35+35+35	1.88	1.88	1.88	2.63	2.63	2.63	4.5	13.5	13.8	1150	3310	3420	15.1	14.4	13.8
25+25+25+35+35+50	1.73	1.73	1.73	2.42	2.42	3.46	4.5	13.5	13.8	1150	3310	3420	15.1	14.4	13.8		
25+25+35+35+35+35	1.78	1.78	2.49	2.49	2.49	2.49	4.5	13.5	13.8	1150	3310	3420	15.1	14.4	13.8		

Indoor unit combination		Cooling capacity (kW)									Power consumption(W)			Standard current(A)		
		Room cooling capacity						Total capacity			Min.	Standard	Max.	220V	230V	240V
		A	B	C	D	E	F	Min.	Standard	Max.						
Cooling operation	1 room	20	2.0	-	-	-	-	1.8	2.0	2.7	650	780	1100	3.6	3.4	3.3
		25	2.5	-	-	-	-	1.8	2.5	3.2	650	1000	1350	4.6	4.4	4.2
		35	3.5	-	-	-	-	1.8	3.5	3.7	650	1500	1600	6.9	6.6	6.3
		50	5.0	-	-	-	-	1.8	5.0	5.8	650	2150	2500	9.9	9.4	9.0
		60	6.0	-	-	-	-	1.8	6.0	6.7	650	2720	3000	12.5	11.9	11.4
		71	7.1	-	-	-	-	1.8	7.1	7.2	650	3250	3080	14.9	14.3	13.7
	2 room	20+20	2.00	2.00	-	-	-	3.0	4.0	5.4	740	960	1460	4.4	4.2	4.0
		20+25	2.00	2.50	-	-	-	3.0	4.5	5.9	740	1100	1820	5.1	4.8	4.6
		20+35	2.00	3.50	-	-	-	3.0	5.5	6.4	740	1500	2020	6.9	6.6	6.3
		20+50	2.00	5.00	-	-	-	3.0	7.0	8.5	740	2290	2820	10.5	10.1	9.6
		20+60	2.00	6.00	-	-	-	3.0	8.0	9.4	740	2660	3360	12.2	11.7	11.2
		20+71	2.00	7.10	-	-	-	3.0	9.1	9.9	740	3100	3780	14.1	13.5	12.9
		25+25	2.50	2.50	-	-	-	3.0	5.0	6.8	740	1420	2200	6.5	6.2	6.0
		25+35	2.50	3.50	-	-	-	3.0	6.0	6.9	740	1810	2320	8.3	7.9	7.6
		25+50	2.50	5.00	-	-	-	3.0	7.5	9.0	740	2470	3220	11.3	10.8	10.4
		25+60	2.50	6.00	-	-	-	3.0	8.5	9.4	740	2810	3360	12.9	12.3	11.8
		25+71	2.53	7.17	-	-	-	3.0	9.7	10.4	740	3350	4020	15.4	14.7	14.1
		35+35	3.50	3.50	-	-	-	3.0	7.0	7.4	740	2290	2820	10.5	10.1	9.6
		35+50	3.50	5.00	-	-	-	3.0	8.5	9.5	740	2810	3620	12.9	12.3	11.8
		35+60	3.50	6.00	-	-	-	3.0	9.5	10.4	740	3280	3990	15.1	14.4	13.8
		35+71	3.50	7.10	-	-	-	3.0	10.6	10.9	740	3760	4250	17.1	16.3	15.7
		50+50	5.00	5.00	-	-	-	3.0	10.0	10.8	740	3520	4050	16.2	15.5	14.8
		50+60	5.00	6.00	-	-	-	3.0	11.0	12.0	740	3870	4410	17.8	17.0	16.3
		50+71	4.96	7.04	-	-	-	3.0	12.0	12.0	740	4410	4410	20.0	19.2	18.4
	60+60	6.00	6.00	-	-	-	3.0	12.0	12.0	740	4410	4410	20.2	19.4	18.6	
	60+71	5.73	6.77	-	-	-	3.0	12.5	12.5	740	4710	4710	21.4	20.5	19.6	
	71+71	6.25	6.25	-	-	-	3.0	12.5	12.5	740	4710	4710	21.2	20.3	19.4	
	3 room	20+20+20	2.00	2.00	2.00	-	-	3.7	6.0	8.1	880	1530	2560	7.0	6.7	6.4
		20+20+25	2.00	2.00	2.50	-	-	3.7	6.5	8.6	880	1730	2700	7.9	7.6	7.3
		20+20+35	2.00	2.00	3.50	-	-	3.7	7.5	9.1	880	2080	3120	9.6	9.1	8.8
		20+20+50	2.00	2.00	5.00	-	-	3.7	9.0	11.2	880	2730	4120	12.5	12.0	11.5
		20+20+60	2.00	2.00	6.00	-	-	3.7	10.0	12.1	880	3280	4680	15.1	14.4	13.8
		20+20+71	2.00	2.00	7.10	-	-	3.7	11.1	12.6	880	3930	4710	18.0	17.3	16.5
		20+25+25	2.00	2.50	2.50	-	-	3.7	7.0	9.1	880	1940	3210	8.9	8.5	8.2
		20+25+35	2.00	2.50	3.50	-	-	3.7	8.0	9.6	880	2440	3450	11.2	10.7	10.3
		20+25+50	2.00	2.50	5.00	-	-	3.7	9.5	11.7	880	3130	4480	14.4	13.7	13.2
		20+25+60	2.00	2.50	6.00	-	-	3.7	10.5	12.6	880	3770	4800	17.3	16.6	15.9
		20+25+71	2.00	2.50	7.10	-	-	3.7	11.6	12.6	880	4210	4800	19.1	18.3	17.5
		20+35+35	2.00	3.50	3.50	-	-	3.7	9.0	10.1	880	2920	3850	13.4	12.8	12.3
		20+35+50	2.00	3.50	5.00	-	-	3.7	10.5	12.0	880	3770	4450	17.3	16.6	15.9
		20+35+60	2.00	3.50	6.00	-	-	3.7	11.5	12.6	880	4150	4800	19.1	18.2	17.5
		20+35+71	1.98	3.47	7.04	-	-	4.7	12.5	12.6	880	4670	4800	21.2	20.3	19.5
20+50+50		2.00	5.00	5.00	-	-	3.7	12.0	12.6	880	4440	4800	20.4	19.5	18.7	



MULTI-SPLIT SYSTEM

Indoor unit combination		Cooling capacity (kW)									Power consumption(W)			Standard current(A)			
		Room cooling capacity						Total capacity			Min.	Standard	Max.	220V	230V	240V	
		A	B	C	D	E	F	Min.	Standard	Max.							
Cooling operation	3 room	20+50+60	1.92	4.81	5.77	-	-	-	3.7	12.5	12.6	880	4670	4800	21.4	20.5	19.7
		20+50+71	1.77	4.43	6.29	-	-	-	3.7	12.5	12.6	881	4670	4800	21.4	20.5	19.7
		20+60+60	1.79	5.36	5.36	-	-	-	3.7	12.5	12.6	881	4670	4800	21.4	20.5	19.7
		20+60+71	1.66	4.97	5.88	-	-	-	3.7	12.5	12.6	881	4670	4800	21.4	20.5	19.7
		20+71+71	1.54	5.48	5.48	-	-	-	3.7	12.5	12.6	881	4660	4800	21.4	20.5	19.6
		25+25+25	2.50	2.50	2.50	-	-	-	3.7	7.5	9.6	880	2130	3640	9.8	9.4	9.0
		25+25+35	2.50	2.50	3.50	-	-	-	3.7	8.5	10.1	880	2650	3900	12.2	11.6	11.2
		25+25+50	2.50	2.50	5.00	-	-	-	3.7	10.0	12.6	880	3420	4800	15.7	15.0	14.4
		25+25+60	2.50	2.50	6.00	-	-	-	3.7	11.0	12.6	880	3910	4800	18.0	17.2	16.5
		25+25+71	2.58	2.58	7.33	-	-	-	3.7	12.5	12.6	880	4670	4800	21.2	20.3	19.5
		25+35+35	2.50	3.50	3.50	-	-	-	3.7	9.5	10.4	880	3130	3910	14.4	13.7	13.2
		25+35+50	2.50	3.50	5.00	-	-	-	3.7	11.0	12.6	880	3910	4800	18.0	17.2	16.5
		25+35+60	2.50	3.50	6.00	-	-	-	3.7	12.0	12.6	880	4440	4800	20.4	19.5	18.7
		25+35+71	2.39	3.34	6.77	-	-	-	3.7	12.5	12.6	880	4670	4800	21.4	20.5	19.7
		25+50+50	2.50	5.00	5.00	-	-	-	3.7	12.5	12.6	880	4670	4800	21.4	20.5	19.7
		25+50+60	2.31	4.63	5.56	-	-	-	3.7	12.5	12.6	880	4670	4800	21.4	20.5	19.7
		25+50+71	2.14	4.28	6.08	-	-	-	3.7	12.5	12.6	880	4670	4800	21.4	20.5	19.7
		25+60+60	2.16	5.17	5.17	-	-	-	3.7	12.5	12.6	880	4670	4800	21.4	20.5	19.7
		25+60+71	2.00	4.81	5.69	-	-	-	3.7	12.5	12.6	880	4670	4800	21.4	20.5	19.7
		25+71+71	1.87	5.31	5.31	-	-	-	3.7	12.5	12.6	880	4670	4800	21.4	20.5	19.7
		35+35+35	3.50	3.50	3.50	-	-	-	3.7	10.5	10.9	880	3770	4180	17.3	16.6	15.9
		35+35+50	3.50	3.50	5.00	-	-	-	3.7	12.0	12.6	880	4440	4800	20.4	19.5	18.7
		35+35+60	3.37	3.37	5.77	-	-	-	3.7	12.5	12.6	880	4670	4800	21.4	20.5	19.7
		35+35+71	3.10	3.10	6.29	-	-	-	3.7	12.5	12.6	880	4660	4800	21.2	20.3	19.4
		35+50+50	3.24	4.63	4.63	-	-	-	3.7	12.5	12.6	880	4670	4800	21.4	20.5	19.7
		35+50+60	3.02	4.31	5.17	-	-	-	3.7	12.5	12.6	880	4660	4800	21.4	20.5	19.6
		35+50+71	2.80	4.01	5.69	-	-	-	3.7	12.5	12.6	880	4660	4800	21.4	20.5	19.6
		35+60+60	2.82	4.84	4.84	-	-	-	3.7	12.5	12.6	880	4660	4800	21.4	20.5	19.6
		35+60+71	2.64	4.52	5.35	-	-	-	3.7	12.5	12.6	880	4660	4800	21.4	20.5	19.6
		35+71+71	2.47	5.01	5.01	-	-	-	3.7	12.5	12.6	880	4650	4800	21.3	20.4	19.6
	50+50+50	4.17	4.17	4.17	-	-	-	3.7	12.5	12.6	880	4660	4800	21.4	20.5	19.6	
	50+50+60	3.91	3.91	4.69	-	-	-	3.7	12.5	12.6	880	4660	4800	21.4	20.5	19.6	
	50+50+71	3.65	3.65	5.19	-	-	-	3.7	12.5	12.6	880	4650	4800	21.3	20.4	19.6	
	50+60+60	3.68	4.41	4.41	-	-	-	3.7	12.5	12.6	880	4650	4800	21.3	20.4	19.6	
	50+60+71	3.45	4.14	4.90	-	-	-	3.7	12.5	12.6	880	4650	4800	21.3	20.4	19.6	
	60+60+60	4.17	4.17	4.17	-	-	-	3.7	12.5	12.6	880	4650	4800	21.3	20.4	19.6	
	60+60+71	3.93	3.93	4.65	-	-	-	3.7	12.5	12.6	880	4650	4800	21.3	20.4	19.6	
	20+20+20+20	2.00	2.00	2.00	2.00	-	-	4.4	8.0	10.8	1100	2110	3680	9.6	9.2	8.8	
	20+20+20+25	2.00	2.00	2.00	2.50	-	-	4.4	8.5	11.3	1100	2390	3890	10.9	10.4	10.0	
	20+20+20+35	2.00	2.00	2.00	3.50	-	-	4.4	9.5	11.8	1100	2900	4350	13.2	12.6	12.1	
	20+20+20+50	2.00	2.00	2.00	5.00	-	-	4.4	11.0	12.8	1100	3580	4800	16.3	15.6	14.9	
	20+20+20+60	2.00	2.00	2.00	6.00	-	-	4.4	12.0	12.8	1100	4100	4800	18.7	17.8	17.1	
20+20+20+71	1.91	1.91	1.91	6.77	-	-	4.4	12.5	12.8	1100	4730	4800	21.3	20.4	19.5		
20+20+25+25	2.00	2.00	2.50	2.50	-	-	4.4	9.0	11.8	1100	2600	4410	11.8	11.3	10.8		
20+20+25+35	2.00	2.00	2.50	3.50	-	-	4.4	10.0	12.3	1100	3210	4780	14.6	14.0	13.4		
20+20+25+50	2.00	2.00	2.50	5.00	-	-	4.4	11.5	12.8	1100	3830	4800	17.4	16.7	16.0		
20+20+25+60	2.00	2.00	2.50	6.00	-	-	4.4	12.5	12.8	1100	4740	4800	21.6	20.6	19.8		
20+20+25+71	1.84	1.84	2.30	6.53	-	-	4.4	12.5	12.8	1100	4730	4800	21.5	20.6	19.7		
20+20+35+35	2.00	2.00	3.50	3.50	-	-	4.4	11.0	12.8	1100	3580	4800	16.3	15.6	14.9		
20+20+35+50	2.00	2.00	3.50	5.00	-	-	4.4	12.5	12.8	1100	4740	4800	21.6	20.6	19.8		
20+20+35+60	1.85	1.85	3.24	5.56	-	-	4.4	12.5	12.8	1100	4730	4800	21.5	20.6	19.7		
20+20+35+71	1.71	1.71	3.00	6.08	-	-	4.4	12.5	12.8	1100	4730	4800	21.5	20.6	19.7		
20+20+50+50	1.79	1.79	4.46	4.46	-	-	4.4	12.5	12.8	1100	4730	4800	21.5	20.6	19.7		
20+20+50+60	1.67	1.67	4.17	5.00	-	-	4.4	12.5	12.8	1100	4730	4800	21.5	20.6	19.7		
20+20+50+71	1.55	1.55	3.88	5.51	-	-	4.4	12.5	12.8	1100	4720	4800	21.5	20.5	19.7		
20+20+60+60	1.56	1.56	4.69	4.69	-	-	4.4	12.5	12.8	1100	4720	4800	21.5	20.5	19.7		
20+20+60+71	1.46	1.46	4.39	5.19	-	-	4.4	12.5	12.8	1100	4720	4800	21.5	20.5	19.7		
20+20+71+71	1.37	1.37	4.88	4.88	-	-	4.4	12.5	12.8	1100	4710	4800	21.4	20.5	19.6		
20+25+25+25	2.00	2.50	2.50	2.50	-	-	4.4	9.5	12.8	1100	2900	4800	13.2	12.6	12.1		
20+25+25+35	2.00	2.50	2.50	3.50	-	-	4.4	10.5	12.8	1100	3440	4800	15.7	15.0	14.3		
20+25+25+50	2.00	2.50	2.50	5.00	-	-	4.4	12.0	12.8	1100	4100	4800	18.7	17.8	17.1		
20+25+25+60	1.92	2.40	2.40	5.77	-	-	4.4	12.5	12.8	1100	4740	4800	21.6	20.6	19.8		
20+25+25+71	1.82	2.26	2.26	6.16	-	-	4.4	12.5	12.8	1100	4730	4800	21.5	20.6	19.7		
20+25+35+35	2.00	2.50	3.50	3.50	-	-	4.4	11.5	12.8	1100	3830	4800	17.4	16.7	16.0		
20+25+35+50	1.92	2.40	3.37	4.81	-	-	4.4	12.5	12.8	1100	4740	4800	21.6	20.6	19.8		
20+25+35+60	1.79	2.23	3.13	5.36	-	-	4.4	12.5	12.8	1100	4730	4800	21.5	20.6	19.7		
20+25+35+71	1.66	2.07	2.90	5.88	-	-	4.4	12.5	12.8	1100	4730	4800	21.5	20.6	19.7		
20+25+50+50	1.72	2.16	4.31	4.31	-	-	4.4	12.5	12.8	1100	4730	4800	21.5	20.6	19.7		
20+25+50+60	1.61	2.02	4.03	4.84	-	-	4.4	12.5	12.8	1100	4720	4800	21.5	20.5	19.7		
20+25+50+71	1.51	1.88	3.77	5.35	-	-	4.4	12.5	12.8	1100	4720	4800	21.5	20.5	19.7		
20+25+60+60	1.52	1.89	4.55	4.55	-	-	4.4	12.5	12.8	1100	4720	4800	21.5	20.5	19.7		
20+25+60+71	1.42	1.78	4.26	5.04	-	-	4.4	12.5	12.8	1100	4720	4800	21.5	20.5	19.7		
20+25+71+71	1.34	1.67	4.75	4.75	-	-	4.4	12.5	12.8	1100	4700	4800	21.4	20.5	19.6		
20+35+35+35	2.00	3.50	3.50	3.50	-	-	4.4	12.5	12.8	1100	4740	4800	21.6	20.6	19.8		
20+35+35+50	1.79	3.13	3.13	4.46	-	-	4.4	12.5	12.8	1100	4730	4800	21.5	20.6	19.7		
20+35+35+60	1.67	2.92	2.92	5.00	-	-	4.4	12.5	12.8	1100	4730	4800	21.5	20.6	19.7		
20+35+35+71	1.55	2.72	2.72	5.51	-	-	4.4	12.5	12.8	1100	4720	4800	21.5	20.5	19.7		

COMBINATIONS

Indoor unit combination		Cooling capacity (kW)									Power consumption(W)			Standard current(A)			
		Room cooling capacity						Total capacity			Min.	Standard	Max.	220V	230V	240V	
		A	B	C	D	E	F	Min.	Standard	Max.							
Cooling operation	4 room	20+35+50+50	1.61	2.82	4.03	4.03	-	-	4.4	12.5	12.8	1100	4720	4800	21.5	20.5	19.7
		20+35+50+60	1.52	2.65	3.79	4.55	-	-	4.4	12.5	12.8	1100	4720	4800	21.5	20.5	19.7
		20+35+50+71	1.42	2.49	3.55	5.04	-	-	4.4	12.5	12.8	1100	4720	4800	21.5	20.5	19.7
		20+35+60+60	1.43	2.50	4.29	4.29	-	-	4.4	12.5	12.8	1100	4710	4800	21.4	20.5	19.6
		20+35+60+71	1.34	2.35	4.03	4.77	-	-	4.4	12.5	12.8	1100	4710	4800	21.4	20.5	19.6
		20+50+50+50	1.47	3.68	3.68	3.68	-	-	4.4	12.5	12.8	1100	4720	4800	21.5	20.5	19.7
		20+50+50+60	1.39	3.47	3.47	4.17	-	-	4.4	12.5	12.8	1100	4710	4800	21.4	20.5	19.6
		20+50+50+71	1.31	3.27	3.27	4.65	-	-	4.4	12.5	12.8	1100	4700	4800	21.4	20.5	19.6
		20+50+60+60	1.32	3.29	3.95	3.95	-	-	4.4	12.5	12.8	1100	4700	4800	21.4	20.5	19.6
		25+25+25+25	2.50	2.50	2.50	2.50	-	-	4.4	10.0	12.8	1100	3210	4800	14.6	14.0	13.4
		25+25+25+35	2.50	2.50	2.50	3.50	-	-	4.4	11.0	12.8	1100	3580	4800	16.3	15.6	14.9
		25+25+25+50	2.50	2.50	2.50	5.00	-	-	4.4	12.5	12.8	1100	4740	4800	21.6	20.6	19.8
		25+25+25+60	2.31	2.31	2.31	5.56	-	-	4.4	12.5	12.8	1100	4730	4800	21.5	20.6	19.7
		25+25+25+71	2.14	2.14	2.14	6.08	-	-	4.4	12.5	12.8	1100	4730	4800	21.5	20.6	19.7
		25+25+35+35	2.50	2.50	3.50	3.50	-	-	4.4	12.0	12.8	1100	4100	4800	18.7	17.8	17.1
		25+25+35+50	2.31	2.31	3.24	4.63	-	-	4.4	12.5	12.8	1100	4730	4800	21.5	20.6	19.7
		25+25+35+60	2.16	2.16	3.02	5.17	-	-	4.4	12.5	12.8	1100	4730	4800	21.5	20.6	19.7
		25+25+35+71	2.00	2.00	2.80	5.69	-	-	4.4	12.5	12.8	1100	4720	4800	21.5	20.5	19.7
		25+25+50+50	2.08	2.08	4.17	4.17	-	-	4.4	12.5	12.8	1100	4730	4800	21.5	20.6	19.7
		25+25+50+60	1.95	1.95	3.91	4.69	-	-	4.4	12.5	12.8	1100	4720	4800	21.5	20.5	19.7
		25+25+50+71	1.83	1.83	3.65	5.19	-	-	4.4	12.5	12.8	1100	4720	4800	21.5	20.5	19.7
		25+25+60+60	1.84	1.84	4.41	4.41	-	-	4.4	12.5	12.8	1100	4720	4800	21.5	20.5	19.7
		25+25+60+71	1.73	1.73	4.14	4.90	-	-	4.4	12.5	12.8	1100	4710	4800	21.4	20.5	19.6
		25+25+71+71	1.63	1.63	4.62	4.62	-	-	4.4	12.5	12.8	1100	4700	4800	21.4	20.5	19.6
		25+35+35+35	2.40	3.37	3.37	3.37	-	-	4.4	12.5	12.8	1100	4740	4800	21.6	20.6	19.8
		25+35+35+50	2.16	3.02	3.02	4.31	-	-	4.4	12.5	12.8	1100	4730	4800	21.5	20.6	19.7
		25+35+35+60	2.02	2.82	2.82	4.84	-	-	4.4	12.5	12.8	1100	4720	4800	21.5	20.5	19.7
		25+35+35+71	1.88	2.64	2.64	5.35	-	-	4.4	12.5	12.8	1100	4720	4800	21.5	20.5	19.7
		25+35+50+50	1.95	2.73	3.91	3.91	-	-	4.4	12.5	12.8	1100	4720	4800	21.5	20.5	19.7
		25+35+50+60	1.84	2.57	3.68	4.41	-	-	4.4	12.5	12.8	1100	4720	4800	21.5	20.5	19.7
		25+35+50+71	1.73	2.42	3.45	4.90	-	-	4.4	12.5	12.8	1100	4710	4800	21.4	20.5	19.6
		25+35+60+60	1.74	2.43	4.17	4.17	-	-	4.4	12.5	12.8	1100	4710	4800	21.4	20.5	19.6
		25+35+60+71	1.64	2.29	3.93	4.65	-	-	4.4	12.5	12.8	1100	4700	4800	21.4	20.5	19.6
		25+50+50+50	1.79	3.57	3.57	3.57	-	-	4.4	12.5	12.8	1100	4710	4800	21.4	20.5	19.6
		25+50+50+60	1.69	3.38	3.38	4.05	-	-	4.4	12.5	12.8	1100	4710	4800	21.4	20.5	19.6
		25+50+60+60	1.60	3.21	3.85	3.85	-	-	4.4	12.5	12.8	1100	4700	4800	21.4	20.5	19.6
		35+35+35+35	3.13	3.13	3.13	3.13	-	-	4.4	12.5	12.8	1100	4730	4800	21.5	20.6	19.7
		35+35+35+50	2.82	2.82	2.82	4.03	-	-	4.4	12.5	12.8	1100	4720	4800	21.5	20.5	19.7
		35+35+35+60	2.65	2.65	2.65	4.55	-	-	4.4	12.5	12.8	1100	4720	4800	21.5	20.5	19.7
		35+35+35+71	2.49	2.49	2.49	5.04	-	-	4.4	12.5	12.8	1100	4710	4800	21.4	20.5	19.6
		35+35+50+50	2.57	2.57	3.68	3.68	-	-	4.4	12.5	12.8	1100	4720	4800	21.5	20.5	19.7
		35+35+50+60	2.43	2.43	3.47	4.17	-	-	4.4	12.5	12.8	1100	4710	4800	21.4	20.5	19.6
35+35+50+71	2.29	2.29	3.27	4.65	-	-	4.4	12.5	12.8	1100	4700	4800	21.4	20.5	19.6		
35+35+60+60	2.30	2.30	3.95	3.95	-	-	4.4	12.5	12.8	1100	4700	4800	21.4	20.5	19.6		
35+50+50+50	2.36	3.38	3.38	3.38	-	-	4.4	12.5	12.8	1100	4710	4800	21.4	20.5	19.6		
35+50+50+60	2.24	3.21	3.21	3.85	-	-	4.4	12.5	12.8	1100	4700	4800	21.4	20.5	19.6		
Cooling operation	5 room	20+20+20+20+20	2.00	2.00	2.00	2.00	2.00	-	5.1	10.0	13.3	1210	2950	4800	13.4	12.8	12.3
		20+20+20+20+25	2.00	2.00	2.00	2.00	2.50	-	5.1	10.5	13.3	1210	3200	4800	14.6	13.9	13.3
		20+20+20+20+35	2.00	2.00	2.00	2.00	3.50	-	5.1	11.5	13.3	1210	3710	4800	16.9	16.1	15.5
		20+20+20+20+50	1.92	1.92	1.92	1.92	4.81	-	5.1	12.5	13.3	1210	4430	4800	20.2	19.3	18.5
		20+20+20+20+60	1.79	1.79	1.79	1.79	5.36	-	5.1	12.5	13.3	1210	4420	4800	20.1	19.2	18.4
		20+20+20+20+71	1.66	1.66	1.66	1.66	5.88	-	5.1	12.5	13.3	1210	4410	4800	20.1	19.2	18.4
		20+20+20+25+25	2.00	2.00	2.00	2.50	2.50	-	5.1	11.0	13.3	1210	3400	4800	15.5	14.8	14.2
		20+20+20+25+35	2.00	2.00	2.00	2.50	3.50	-	5.1	12.0	13.3	1210	4090	4800	18.6	17.8	17.1
		20+20+20+25+50	1.85	1.85	1.85	2.31	4.63	-	5.1	12.5	13.3	1210	4430	4800	20.2	19.3	18.5
		20+20+20+25+60	1.72	1.72	1.72	2.16	5.17	-	5.1	12.5	13.3	1210	4420	4800	20.1	19.2	18.4
		20+20+20+25+71	1.60	1.60	1.60	2.00	5.69	-	5.1	12.5	13.3	1210	4410	4800	20.1	19.2	18.4
		20+20+20+35+35	1.92	1.92	1.92	3.37	3.37	-	5.1	12.5	13.3	1210	4430	4800	20.2	19.3	18.5
		20+20+20+35+50	1.72	1.72	1.72	3.02	4.31	-	5.1	12.5	13.3	1210	4420	4800	20.1	19.2	18.4
		20+20+20+35+60	1.61	1.61	1.61	2.82	4.84	-	5.1	12.5	13.3	1210	4410	4800	20.1	19.2	18.4
		20+20+20+35+71	1.51	1.51	1.51	2.64	5.35	-	5.1	12.5	13.3	1210	4400	4800	20.0	19.1	18.4
		20+20+20+50+50	1.56	1.56	1.56	3.91	3.91	-	5.1	12.5	13.3	1210	4410	4800	20.1	19.2	18.4
		20+20+20+50+60	1.47	1.47	1.47	3.68	4.41	-	5.1	12.5	13.3	1210	4400	4800	20.0	19.1	18.4
		20+20+20+50+71	1.38	1.38	1.38	3.45	4.90	-	5.1	12.5	13.3	1210	4390	4800	20.0	19.1	18.3
		20+20+20+60+60	1.39	1.39	1.39	4.17	4.17	-	5.1	12.5	13.3	1210	4390	4800	20.0	19.1	18.3
		20+20+20+60+71	1.31	1.31	1.31	3.93	4.65	-	5.1	12.5	13.3	1210	4380	4800	19.9	19.1	18.3
		20+20+25+25+25	2.00	2.00	2.50	2.50	2.50	-	5.1	11.5	13.3	1210	3710	4800	16.9	16.1	15.5
		20+20+25+25+35	2.00	2.00	2.50	2.50	3.50	-	5.1	12.5	13.3	1210	4440	4800	20.2	19.3	18.5
		20+20+25+25+50	1.79	1.79	2.23	2.23	4.46	-	5.1	12.5	13.3	1210	4420	4800	20.1	19.2	18.4
		20+20+25+25+60	1.67	1.67	2.08	2.08	5.00	-	5.1	12.5	13.3	1210	4410	4800	20.1	19.2	18.4
		20+20+25+25+71	1.55	1.55	1.94	1.94	5.51	-	5.1	12.5	13.3	1210	4410	4800	20.1	19.2	18.4
		20+20+25+35+35	1.85	1.85	2.31	3.24	3.24	-	5.1	12.5	13.3	1210	4430	4800	20.2	19.3	18.5
		20+20+25+35+50	1.67	1.67	2.08	2.92	4.17	-	5.1	12.5	13.3	1210	4410	4800	20.1	19.2	18.4
		20+20+25+35+60	1.56	1.56	1.95	2.73	4.69	-	5.1	12.5	13.3	1210	4410	4800	20.1	19.2	18.4
		20+20+25+35+71	1.46	1.46	1.83	2.56	5.19	-	5.1	12.5	13.3	1210	4400	4800	20.0	19.1	18.4
		20+20+25+50+50	1.52	1.52	1.89	3.79	3.79	-	5.1	12.5	13.3	1210	4400	4800	20.0	19.1	18.4
		20+20+25+50+60	1.43	1.43	1.79	3.57	4.29	-	5.1	12.5	13.3	1210	4390	4800	20.0	19.1	18.3



MULTI-SPLIT SYSTEM

Indoor unit combination		Cooling capacity (kW)									Power consumption(W)			Standard current(A)			
		Room cooling capacity						Total capacity			Min.	Standard	Max.	220V	230V	240V	
		A	B	C	D	E	F	Min.	Standard	Max.							
Cooling operation	5 room	20+20+25+50+71	1.34	1.34	1.68	3.36	4.77	-	5.1	12.5	13.3	1210	4390	4800	20.0	19.1	18.3
		20+20+25+60+60	1.35	1.35	1.69	4.05	4.05	-	5.1	12.5	13.3	1210	4390	4800	20.0	19.1	18.3
		20+20+35+35+35	1.72	1.72	3.02	3.02	3.02	-	5.1	12.5	13.3	1210	4420	4800	20.1	19.2	18.4
		20+20+35+35+50	1.56	1.56	2.73	2.73	3.91	-	5.1	12.5	13.3	1210	4410	4800	20.1	19.2	18.4
		20+20+35+35+60	1.47	1.47	2.57	2.57	4.41	-	5.1	12.5	13.3	1210	4400	4800	20.0	19.1	18.4
		20+20+35+35+71	1.38	1.38	2.42	2.42	4.90	-	5.1	12.5	13.3	1210	4390	4800	20.0	19.1	18.3
		20+20+35+50+50	1.43	1.43	2.50	3.57	3.57	-	5.1	12.5	13.3	1210	4390	4800	20.0	19.1	18.3
		20+20+35+50+60	1.35	1.35	2.36	3.38	4.05	-	5.1	12.5	13.3	1210	4390	4800	20.0	19.1	18.3
		20+20+35+60+60	1.28	1.28	2.24	3.85	3.85	-	5.1	12.5	13.3	1210	4380	4800	19.9	19.1	18.3
		20+20+50+50+50	1.32	1.32	3.29	3.29	3.29	-	5.1	12.5	13.3	1210	4380	4800	19.9	19.1	18.3
		20+25+25+25+25	2.00	2.50	2.50	2.50	2.50	-	5.1	12.0	13.3	1210	4090	4800	18.6	17.8	17.1
		20+25+25+25+35	1.92	2.40	2.40	2.40	3.37	-	5.1	12.5	13.3	1210	4430	4800	20.2	19.3	18.5
		20+25+25+25+50	1.72	2.16	2.16	2.16	4.31	-	5.1	12.5	13.3	1210	4420	4800	20.1	19.2	18.4
		20+25+25+25+60	1.61	2.02	2.02	2.02	4.84	-	5.1	12.5	13.3	1210	4410	4800	20.1	19.2	18.4
		20+25+25+25+71	1.51	1.88	1.88	1.88	5.35	-	5.1	12.5	13.3	1210	4400	4800	20.0	19.1	18.4
		20+25+25+35+35	1.79	2.23	2.23	3.13	3.13	-	5.1	12.5	13.3	1210	4420	4800	20.1	19.2	18.4
		20+25+25+35+50	1.61	2.02	2.02	2.82	4.03	-	5.1	12.5	13.3	1210	4410	4800	20.1	19.2	18.4
		20+25+25+35+60	1.52	1.89	1.89	2.65	4.55	-	5.1	12.5	13.3	1210	4400	4800	20.0	19.1	18.4
		20+25+25+35+71	1.42	1.78	1.78	2.49	5.04	-	5.1	12.5	13.3	1210	4390	4800	20.0	19.1	18.3
		20+25+25+50+50	1.47	1.84	1.84	3.68	3.68	-	5.1	12.5	13.3	1210	4400	4800	20.0	19.1	18.4
		20+25+25+50+60	1.39	1.74	1.74	3.47	4.17	-	5.1	12.5	13.3	1210	4390	4800	20.0	19.1	18.3
		20+25+25+50+71	1.31	1.64	1.64	3.27	4.65	-	5.1	12.5	13.3	1210	4380	4800	19.9	19.1	18.3
		20+25+25+60+60	1.32	1.64	1.64	3.95	3.95	-	5.1	12.5	13.3	1210	4380	4800	19.9	19.1	18.3
		20+25+35+35+35	1.67	2.08	2.92	2.92	2.92	-	5.1	12.5	13.3	1210	4410	4800	20.1	19.2	18.4
		20+25+35+35+50	1.52	1.89	2.65	2.65	3.79	-	5.1	12.5	13.3	1210	4400	4800	20.0	19.1	18.4
		20+25+35+35+60	1.43	1.79	2.50	2.50	4.29	-	5.1	12.5	13.3	1210	4390	4800	20.0	19.1	18.3
		20+25+35+35+71	1.34	1.68	2.35	2.35	4.77	-	5.1	12.5	13.3	1210	4390	4800	20.0	19.1	18.3
		20+25+35+50+50	1.39	1.74	2.43	3.47	3.47	-	5.1	12.5	13.3	1210	4390	4800	20.0	19.1	18.3
		20+25+35+50+60	1.32	1.64	2.30	3.29	3.95	-	5.1	12.5	13.3	1210	4380	4800	19.9	19.1	18.3
		20+25+50+50+50	1.28	1.60	3.21	3.21	3.21	-	5.1	12.5	13.3	1210	4380	4800	19.9	19.1	18.3
		20+35+35+35+35	1.56	2.73	2.73	2.73	2.73	-	5.1	12.5	13.3	1210	4410	4800	20.1	19.2	18.4
		20+35+35+35+50	1.43	2.50	2.50	2.50	3.57	-	5.1	12.5	13.3	1210	4390	4800	20.0	19.1	18.3
		20+35+35+35+60	1.35	2.36	2.36	2.36	4.05	-	5.1	12.5	13.3	1210	4390	4800	20.0	19.1	18.3
		20+35+35+50+50	1.32	2.30	2.30	3.29	3.29	-	5.1	12.5	13.3	1210	4380	4800	19.9	19.1	18.3
		25+25+25+25+25	2.50	2.50	2.50	2.50	2.50	-	5.1	12.5	13.3	1210	4440	4800	20.2	19.3	18.5
		25+25+25+25+35	2.31	2.31	2.31	2.31	3.24	-	5.1	12.5	13.3	1210	4430	4800	20.2	19.3	18.5
		25+25+25+25+50	2.08	2.08	2.08	2.08	4.17	-	5.1	12.5	13.3	1210	4410	4800	20.1	19.2	18.4
		25+25+25+25+60	1.95	1.95	1.95	1.95	4.69	-	5.1	12.5	13.3	1210	4410	4800	20.1	19.2	18.4
		25+25+25+35+35	2.16	2.16	2.16	3.02	3.02	-	5.1	12.5	13.3	1210	4420	4800	20.1	19.2	18.4
		25+25+25+35+50	1.95	1.95	1.95	2.73	3.91	-	5.1	12.5	13.3	1210	4410	4800	20.1	19.2	18.4
25+25+25+35+60	1.84	1.84	1.84	2.57	4.41	-	5.1	12.5	13.3	1210	4400	4800	20.0	19.1	18.4		
25+25+25+35+71	1.73	1.73	1.73	2.42	4.90	-	5.1	12.5	13.3	1210	4390	4800	20.0	19.1	18.3		
25+25+25+50+50	1.79	1.79	1.79	3.57	3.57	-	5.1	12.5	13.3	1210	4390	4800	20.0	19.1	18.3		
25+25+25+50+60	1.69	1.69	1.69	3.38	4.05	-	5.1	12.5	13.3	1210	4390	4800	20.0	19.1	18.3		
25+25+25+60+60	1.60	1.60	1.60	3.85	3.85	-	5.1	12.5	13.3	1210	4380	4800	19.9	19.1	18.3		
25+25+35+35+35	2.02	2.02	2.82	2.82	2.82	-	5.1	12.5	13.3	1210	4410	4800	20.1	19.2	18.4		
25+25+35+35+50	1.84	1.84	2.57	2.57	3.68	-	5.1	12.5	13.3	1210	4400	4800	20.0	19.1	18.4		
25+25+35+35+60	1.74	1.74	2.43	2.43	4.17	-	5.1	12.5	13.3	1210	4390	4800	20.0	19.1	18.3		
25+25+35+35+71	1.64	1.64	2.29	2.29	4.65	-	5.1	12.5	13.3	1210	4380	4800	19.9	19.1	18.3		
25+25+35+50+50	1.69	1.69	2.36	3.38	3.38	-	5.1	12.5	13.3	1210	4390	4800	20.0	19.1	18.3		
25+25+35+50+60	1.60	1.60	2.24	3.21	3.85	-	5.1	12.5	13.3	1210	4380	4800	19.9	19.1	18.3		
25+35+35+35+35	1.89	2.65	2.65	2.65	2.65	-	5.1	12.5	13.3	1210	4400	4800	20.0	19.1	18.4		
25+35+35+35+50	1.74	2.43	2.43	2.43	3.47	-	5.1	12.5	13.3	1210	4390	4800	20.0	19.1	18.3		
25+35+35+35+60	1.64	2.30	2.30	2.30	3.95	-	5.1	12.5	13.3	1210	4380	4800	19.9	19.1	18.3		
25+35+35+50+50	1.60	2.24	2.24	3.21	3.21	-	5.1	12.5	13.3	1210	4380	4800	19.9	19.1	18.3		
35+35+35+35+35	2.50	2.50	2.50	2.50	2.50	-	5.1	12.5	13.3	1210	4390	4800	20.0	19.1	18.3		
35+35+35+35+50	2.30	2.30	2.30	2.30	3.29	-	5.1	12.5	13.3	1210	4380	4800	19.9	19.1	18.3		

COMBINATIONS

Indoor unit combination		Cooling capacity (kW)									Power consumption(W)			Standard current(A)			
		Room cooling capacity						Total capacity			Min.	Standard	Max.	220V	230V	240V	
		A	B	C	D	E	F	Min.	Standard	Max.							
Cooling operation	6 room	20+20+20+20+20+20	2.00	2.00	2.00	2.00	2.00	2.00	5.5	12.0	13.6	1280	3750	4620	17.1	16.3	15.6
		20+20+20+20+20+25	2.00	2.00	2.00	2.00	2.00	2.50	5.5	12.5	13.3	1280	4010	4800	18.2	17.5	16.7
		20+20+20+20+20+35	1.85	1.85	1.85	1.85	1.85	3.24	5.5	12.5	13.3	1280	4000	4800	18.2	17.4	16.7
		20+20+20+20+20+50	1.67	1.67	1.67	1.67	1.67	4.17	5.5	12.5	13.3	1280	3990	4800	18.2	17.4	16.6
		20+20+20+20+20+60	1.56	1.56	1.56	1.56	1.56	4.69	5.5	12.5	13.3	1280	3990	4800	18.2	17.4	16.6
		20+20+20+20+20+71	1.46	1.46	1.46	1.46	1.46	5.19	5.5	12.5	13.8	1280	3980	4800	18.1	17.3	16.6
		20+20+20+20+25+25	1.92	1.92	1.92	1.92	2.40	2.40	5.5	12.5	13.8	1280	4000	4800	18.2	17.4	16.7
		20+20+20+20+25+35	1.79	1.79	1.79	1.79	2.23	3.13	5.5	12.5	13.8	1280	4000	4800	18.2	17.4	16.7
		20+20+20+20+25+50	1.61	1.61	1.61	1.61	2.02	4.03	5.5	12.5	13.8	1280	3990	4800	18.2	17.4	16.6
		20+20+20+20+25+60	1.52	1.52	1.52	1.52	1.89	4.55	5.5	12.5	13.8	1280	3990	4800	18.2	17.4	16.6
		20+20+20+20+35+35	1.67	1.67	1.67	1.67	2.92	2.92	5.5	12.5	13.8	1280	3990	4800	18.2	17.4	16.6
		20+20+20+20+35+50	1.52	1.52	1.52	1.52	2.65	3.79	5.5	12.5	13.8	1280	3990	4800	18.2	17.4	16.6
		20+20+20+20+35+60	1.43	1.43	1.43	1.43	2.50	4.29	5.5	12.5	13.8	1280	3980	4800	18.1	17.3	16.6
		20+20+20+20+35+71	1.34	1.34	1.34	1.34	2.35	4.77	5.5	12.5	13.8	1280	3980	4800	18.1	17.3	16.6
		20+20+20+20+50+50	1.39	1.39	1.39	1.39	3.47	3.47	5.5	12.5	13.8	1280	3980	4800	18.1	17.3	16.6
		20+20+20+20+50+60	1.32	1.32	1.32	1.32	3.29	3.95	5.5	12.5	13.8	1280	3970	4800	18.1	17.3	16.6
		20+20+20+25+25+25	1.85	1.85	1.85	2.31	2.31	2.31	5.5	12.5	13.8	1280	4000	4800	18.2	17.4	16.7
		20+20+20+25+25+35	1.72	1.72	1.72	2.16	2.16	3.02	5.5	12.5	13.8	1280	4000	4800	18.2	17.4	16.7
		20+20+20+25+25+50	1.56	1.56	1.56	1.95	1.95	3.91	5.5	12.5	13.8	1280	3990	4800	18.2	17.4	16.6
		20+20+20+25+25+60	1.47	1.47	1.47	1.84	1.84	4.41	5.5	12.5	13.8	1280	3980	4800	18.1	17.3	16.6
		20+20+20+25+25+71	1.38	1.38	1.38	1.73	1.73	4.90	5.5	12.5	13.8	1280	3980	4800	18.1	17.3	16.6
		20+20+20+25+35+35	1.61	1.61	1.61	2.02	2.82	2.82	5.5	12.5	13.8	1280	3990	4800	18.2	17.4	16.6
		20+20+20+25+35+50	1.47	1.47	1.47	1.84	2.57	3.68	5.5	12.5	13.8	1280	3980	4800	18.1	17.3	16.6
		20+20+20+25+35+60	1.39	1.39	1.39	1.74	2.43	4.17	5.5	12.5	13.8	1280	3980	4800	18.1	17.3	16.6
		20+20+20+25+35+71	1.31	1.31	1.31	1.64	2.29	4.65	5.5	12.5	13.8	1280	3970	4800	18.1	17.3	16.6
		20+20+20+25+50+50	1.35	1.35	1.35	1.69	3.38	3.38	5.5	12.5	13.8	1280	3980	4800	18.1	17.3	16.6
		20+20+20+25+50+60	1.28	1.28	1.28	1.60	3.21	3.85	5.5	12.5	13.8	1280	3970	4800	18.1	17.3	16.6
		20+20+20+35+35+35	1.52	1.52	1.52	2.65	2.65	2.65	5.5	12.5	13.8	1280	3990	4800	18.2	17.4	16.6
		20+20+20+35+35+50	1.39	1.39	1.39	2.43	2.43	3.47	5.5	12.5	13.8	1280	3980	4800	18.1	17.3	16.6
		20+20+20+35+35+60	1.32	1.32	1.32	2.30	2.30	3.95	5.5	12.5	13.8	1280	3970	4800	18.1	17.3	16.6
		20+20+20+35+50+50	1.28	1.28	1.28	2.24	3.21	3.21	5.5	12.5	13.8	1280	3970	4800	18.1	17.3	16.6
		20+20+25+25+25+25	1.79	1.79	2.23	2.23	2.23	2.23	5.5	12.5	13.8	1280	4000	4800	18.2	17.4	16.7
		20+20+25+25+25+35	1.67	1.67	2.08	2.08	2.08	2.92	5.5	12.5	13.8	1280	3990	4800	18.2	17.4	16.6
		20+20+25+25+25+50	1.52	1.52	1.89	1.89	1.89	3.79	5.5	12.5	13.8	1280	3990	4800	18.2	17.4	16.6
		20+20+25+25+25+60	1.43	1.43	1.79	1.79	1.79	4.29	5.5	12.5	13.8	1280	3980	4800	18.1	17.3	16.6
		20+20+25+25+25+71	1.34	1.34	1.68	1.68	1.68	4.77	5.5	12.5	13.8	1280	3980	4800	18.1	17.3	16.6
		20+20+25+25+35+35	1.56	1.56	1.95	1.95	2.73	2.73	5.5	12.5	13.8	1280	3990	4800	18.2	17.4	16.6
		20+20+25+25+35+50	1.43	1.43	1.79	1.79	2.50	3.57	5.5	12.5	13.8	1280	3980	4800	18.1	17.3	16.6
		20+20+25+25+35+60	1.35	1.35	1.69	1.69	2.36	4.05	5.5	12.5	13.8	1280	3980	4800	18.1	17.3	16.6
		20+20+25+25+50+50	1.32	1.32	1.64	1.64	3.29	3.29	5.5	12.5	13.8	1280	3970	4800	18.1	17.3	16.6
		20+20+25+35+35+35	1.47	1.47	1.84	2.57	2.57	2.57	5.5	12.5	13.8	1280	3980	4800	18.1	17.3	16.6
		20+20+25+35+35+50	1.35	1.35	1.69	2.36	2.36	3.38	5.5	12.5	13.8	1280	3980	4800	18.1	17.3	16.6
		20+20+25+35+35+60	1.28	1.28	1.60	2.24	2.24	3.85	5.5	12.5	13.8	1280	3970	4800	18.1	17.3	16.6
		20+20+35+35+35+35	1.39	1.39	2.43	2.43	2.43	2.43	5.5	12.5	13.8	1280	3980	4800	18.1	17.3	16.6
		20+20+35+35+35+50	1.28	1.28	2.24	2.24	2.24	3.21	5.5	12.5	13.8	1280	3970	4800	18.1	17.3	16.6
20+25+25+25+25+25	1.72	2.16	2.16	2.16	2.16	2.16	5.5	12.5	13.8	1280	4000	4800	18.2	17.4	16.7		
20+25+25+25+25+35	1.61	2.02	2.02	2.02	2.02	2.82	5.5	12.5	13.8	1280	3990	4800	18.2	17.4	16.6		
20+25+25+25+25+50	1.47	1.84	1.84	1.84	1.84	3.68	5.5	12.5	13.8	1280	3980	4800	18.1	17.3	16.6		
20+25+25+25+25+60	1.39	1.74	1.74	1.74	1.74	4.17	5.5	12.5	13.8	1280	3980	4800	18.1	17.3	16.6		
20+25+25+25+25+71	1.31	1.64	1.64	1.64	1.64	4.65	5.5	12.5	13.8	1280	3970	4800	18.1	17.3	16.6		
20+25+25+25+35+35	1.52	1.89	1.89	1.89	2.65	2.65	5.5	12.5	13.8	1280	3990	4800	18.2	17.4	16.6		
20+25+25+25+35+50	1.39	1.74	1.74	1.74	2.43	3.47	5.5	12.5	13.8	1280	3980	4800	18.1	17.3	16.6		
20+25+25+25+35+60	1.32	1.64	1.64	1.64	2.30	3.95	5.5	12.5	13.8	1280	3970	4800	18.1	17.3	16.6		
20+25+25+25+50+50	1.28	1.60	1.60	1.60	3.21	3.21	5.5	12.5	13.8	1280	3970	4800	18.1	17.3	16.6		
20+25+25+35+35+35	1.43	1.79	1.79	2.50	2.50	2.50	5.5	12.5	13.8	1280	3980	4800	18.1	17.3	16.6		
20+25+25+35+35+50	1.32	1.64	1.64	2.30	2.30	3.29	5.5	12.5	13.8	1280	3970	4800	18.1	17.3	16.6		
20+25+35+35+35+35	1.35	1.69	2.36	2.36	2.36	2.36	5.5	12.5	13.8	1280	3980	4800	18.1	17.3	16.6		
25+35+35+35+35+35	1.28	2.24	2.24	2.24	2.24	2.24	5.5	12.5	13.8	1280	3970	4800	18.1	17.3	16.6		
25+25+25+25+25+25	2.08	2.08	2.08	2.08	2.08	2.08	5.5	12.5	13.8	1280	3990	4800	18.2	17.4	16.6		
25+25+25+25+25+35	1.95	1.95	1.95	1.95	1.95	2.73	5.5	12.5	13.8	1280	3990	4800	18.2	17.4	16.6		
25+25+25+25+25+50	1.79	1.79	1.79	1.79	1.79	3.57	5.5	12.5	13.8	1280	3980	4800	18.1	17.3	16.6		
25+25+25+25+25+60	1.69	1.69	1.69	1.69	1.69	4.05	5.5	12.5	13.8	1280	3980	4800	18.1	17.3	16.6		
25+25+25+25+35+35	1.84	1.84	1.84	1.84	2.57	2.57	5.5	12.5	13.8	1280	3980	4800	18.1	17.3	16.6		
25+25+25+25+35+50	1.69	1.69	1.69	1.69	2.36	3.38	5.5	12.5	13.8	1280	3980	4800	18.1	17.3	16.6		
25+25+25+25+35+60	1.60	1.60	1.60	1.60	2.24	3.85	5.5	12.5	13.8	1280	3970	4800	18.1	17.3	16.6		
25+25+25+35+35+35	1.74	1.74	1.74	2.43	2.43	2.43	5.5	12.5	13.8	1280	3980	4800	18.1	17.3	16.6		
25+25+25+35+35+50	1.60	1.60	1.60	2.24	2.24	3.21	5.5	12.5	13.8	1280	3970	4800	18.1	17.3	16.6		
25+25+35+35+35+35	1.64	1.64	2.30	2.30	2.30	2.30	5.5	12.5	13.8	1280	3970	4800	18.1	17.3	16.6		

CONTROL SYSTEM

Wired Remote Control (option)

RC-ES1 Stylish wired remote control



reddot winner 2025



H86 x W86 x D17 mm

- Stylish and sophisticated design
- Compact size (86x86mm)
- Remote control with Bluetooth® wireless technology

*The Bluetooth® word mark and logos are registered trademarks owned by Bluetooth SIG, Inc. and any use of such marks by MITSUBISHI HEAVY INDUSTRIES THERMAL SYSTEMS, LTD. is under license.

Wireless connection



Remote control with Bluetooth® wireless technology. Easy set-up of indoor units.

Notifications of abnormal conditions or operational data from the remote control will be sent to your smartphone.

You can control the air-conditioner by installing App on your Smartphone



Search for "M-Air PRO" from the Google Play™ store for Android™ and App Store for iPhone.



Please check the app stores for the latest supported OS version information. App Store and iPhone are registered trademark of Apple Inc. Google Play and the Google Play logo are trademarks of Google LLC.

RC-EX3D

Advanced wired remote control

The RC-EX3D controller enables extensive access to service and maintenance data combined with easy to use full dot LCD backlight display. All settings are changed by tapping the touch screen panel.

- **Economy & Timer:**
Peak cut timer. Home Leave Operation. Energy-saving operation.
- **Comfort:**
Hi power operation. Automatic fan speed. Outdoor silent mode.
- **Convenience:**
Multi language settings. LCD contrast setting. Function switch. External Input/Output Function
- **Service:**
Error code display. Operation data display. Backup Control.



H120 x W120 x D19 mm

RC-E5

Wired remote control

The RC-E5 controller enables extensive access to service and maintenance technical data combined with easy to use functions and a clear LCD display. Weekly timer function as standard.



H120 x W120 x D19 mm

Wireless remote control (option)

For wireless control simply insert the infrared receiver kit on a corner of the panel.

RCN-TC-5AW-E3
(FDTC-VH1,VH)



RCN-TC-24W-E2
(FDTC-VF)

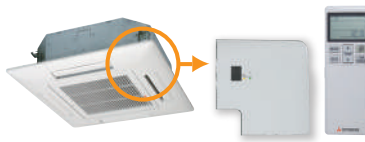

RCN-KIT4-E2
(FDUM-VH)



RCN-E-E3
(FDE-VH)



CONTROL OPTION

Wired remote control can be connected using the interface **SC-BIKN2-E**

Model	Interface	Remote Control
SRK-ZSX-WF*1, -W, -S SRK-ZR-WF*1, -W, -S SRK-ZS-WF*1, -W, -S SRK-ZT-WF*2, -W, -S SRK-ZTL*1 SRF-ZS, ZSX, ZMX SRR-ZS, ZM	SC-BIKN2-E SC-BIKN2-BL*3	RC-EX3D RC-E5 RC-ES1
FDTC-VH1, VH, VF FDUM50VH FDE50VH	not required	

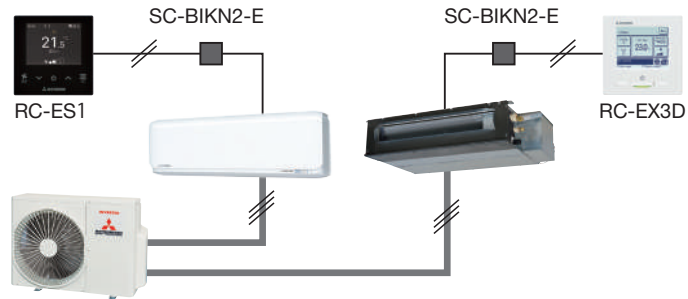

Can be connected to **SUPERLINK-II** using the interface **SC-ADNA-E**

Model	Interface	Remote Control
SRK-ZSX-WF*1, -W, -S SRK-ZR-WF*1, -W, -S SRK-ZS-WF*1, -W, -S SRK-ZT-WF*2, -W, -S SRK-ZTL*1 SRF-ZS, ZSX, ZMX SRR-ZS, ZM	SC-BIKN2-E SC-BIKN2-BL*3 SC-ADNA-E	RC-EX3D RC-E5 RC-ES1
FDTC-VH1, VH, VF FDUM50VH FDE50VH	SC-ADNA-E	

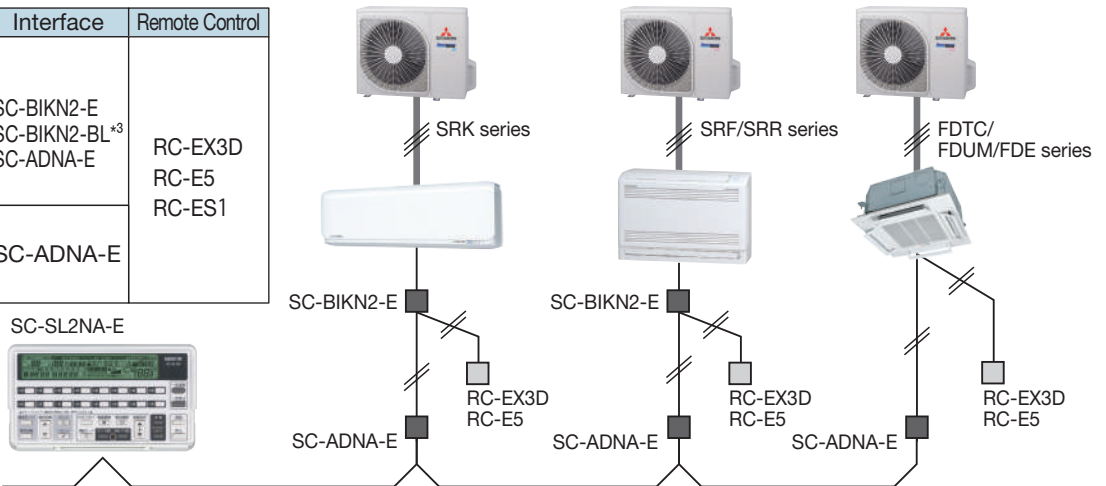

External switch connection CnT

All indoor units can be compatible with an additional connection point - CnT - to connect indoor units to an external ON/OFF switch; e.g. time clock, fire alarm, etc.



Remote surveillance system



Card key on-off

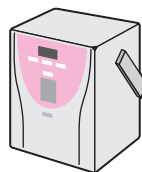

Humidifier linkage

Model	Interface
SRK-ZSX-WF*1, -W, -S SRK-ZR-WF*1, -W, -S SRK-ZS-WF*1, -W, -S SRK-ZT-WF*2, -W, -S SRK-ZTL*1 SRF-ZS, ZSX, ZMX SRR-ZS, ZM	SC-BIKN2-E SC-BIKN2-BL*3
FDTC-VH1, VH, VF FDUM50VH FDE50VH	not required

*1 Wired Remote control, SUPERLINK-II and CnT can be used but required SC-BIKN2-E connected to CNS and Wireless LAN control function will be no longer available.

*2 Wired Remote control, SUPERLINK-II and CnT can be used but required SC-BIKN2-E connected to CNS.

*3 Only compatible with the ZT series.

DIMENSIONS (Unit: mm)

SRK20ZSX-WF, -WFB, -WFT, -W
 SRK25ZSX-WF, -WFB, -WFT, -W
 SRK35ZSX-WF, -WFB, -WFT, -W
 SRK50ZSX-WF, -WFB, -WFT, -W
 SRK60ZSX-WF, -WFB, -WFT, -W
 SRK20ZSX-S SRK25ZSX-S SRK35ZSX-S
 SRK50ZSX-S SRK60ZSX-S

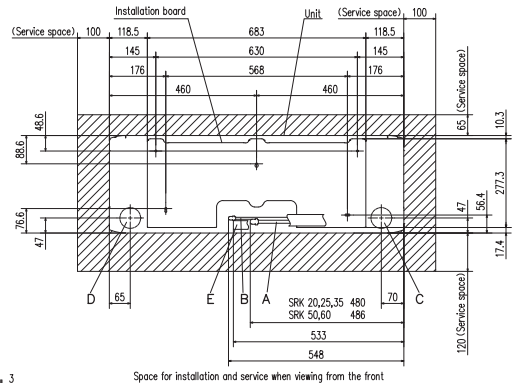
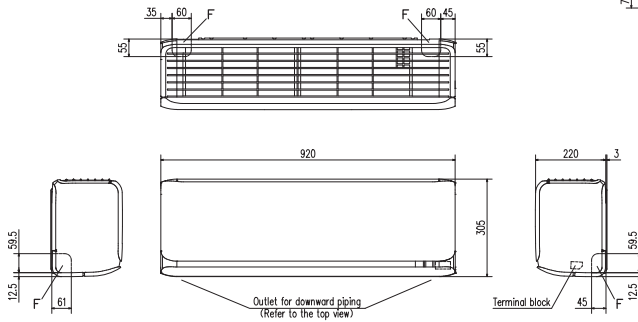

Space for installation and service when viewing from the front

Symbol	Content
A	Gas piping SRK 20,25,35 480 486 SRK 50,60 486
B	Liquid piping 480 486
C	Hole on wall for right rear piping (φ65)
D	Hole on wall for left rear piping (φ65)
E	Drain hose VP16
F	Outlet for piping

- Notes (1) The model name label is attached on the right side of the unit.
 (2) To connect the wired remote control, the interface kit (SC-BIKN2-E) is required.

SRK63ZR-WF, -W SRK71ZR-WF, -W
 SRK80ZR-WF, -W SRK100ZR-WF, -W
 SRK63ZR-S SRK71ZR-S
 SRK80ZR-S SRK100ZR-S

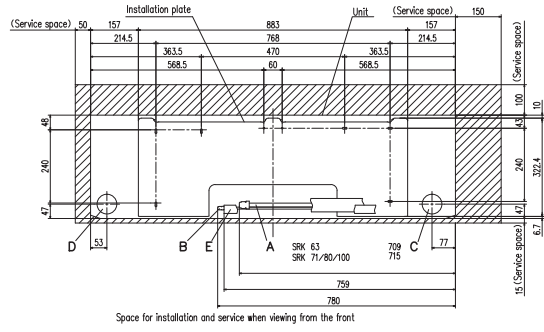
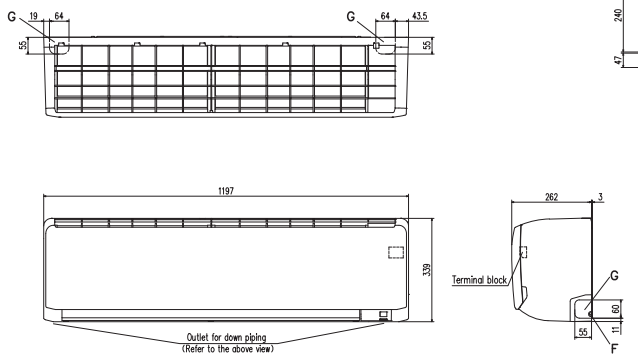

Space for installation and service when viewing from the front

Symbol	Content
A	Gas piping SRK 63 412.7 (1/2") (Flare) SRK 71,80/100 415.88 (1/2") (Flare)
B	Liquid piping SRK 63,71,80 486.35 (1/4") (Flare) SRK 100 486.35 (1/4") (Flare)
C	Hole on wall for right rear piping (φ65)
D	Hole on wall for left rear piping (φ65)
E	Drain hose VP16
F	Outlet for wiring (on both side)
G	Outlet for piping (on both side)

- Notes (1) The model name label is attached on the right side of the unit.
 (2) To connect the wired remote control, the interface kit (SC-BIKN2-E) is required.

SRK20ZT-WF, -WFB, -WFT
 SRK25ZT-WF, -WFB, -WFT
 SRK35ZT-WF, -WFB, -WFT
 SRK50ZT-WF, -WFB, -WFT

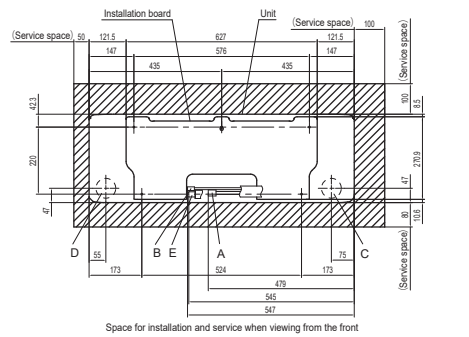
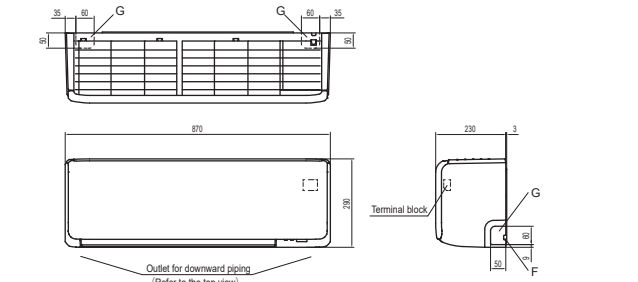

Space for installation and service when viewing from the front

Symbol	Content
A	Gas piping SRK 20,25,35 480 486 SRK 50 486
B	Liquid piping 480 486
C	Hole on wall for right rear piping (φ65)
D	Hole on wall for left rear piping (φ65)
E	Drain hose VP16
F	Outlet for wiring (on both side)
G	Outlet for piping (on both side)

- Notes (1) The model name label is attached on the right side of the indoor unit.
 (2) To connect the wired remote control, the interface kit (SC-BIKN2-E or SC-BIKN2-BL) are required. SC-BIKN2-E is externally mounted interface unit. SC-BIKN2-BL is internally mounted interface unit.

INDOOR UNIT

SRK15ZS-WF, -WFB, -WFT
SRK20ZS-WF, -WFB, -WFT, -W
SRK25ZS-WF, -WFB, -WFT, -W
SRK35ZS-WF, -WFB, -WFT, -W
SRK50ZS-WF, -WFB, -WFT, -W
SRK20ZS-S, -SB, -ST SRK25ZS-S, -SB, -ST
SRK35ZS-S, -SB, -ST SRK50ZS-S, -SB, -ST

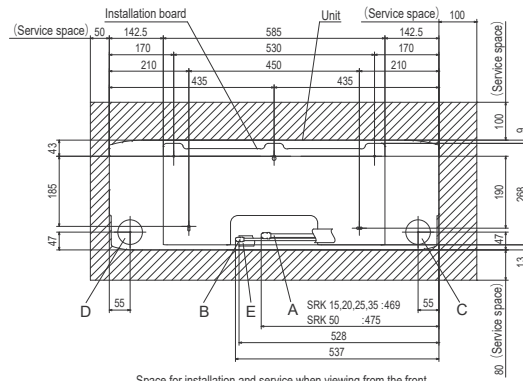
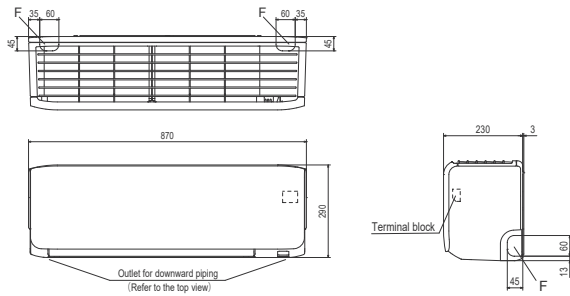

Space for installation and service when viewing from the front

Symbol	Content
A	Gas piping SRK15, 20, 25, 35 ϕ 9.52 (3/8") (Flare) SRK50 ϕ 12.7 (1/2") (Flare)
B	Liquid piping ϕ 6.35 (1/4") (Flare)
C	Hole on wall for right rear piping (ϕ 65)
D	Hole on wall for left rear piping (ϕ 65)
E	Drain hose VP16
F	Outlet for piping (on both side)

Notes (1) The model name label is attached on the right side of the unit.
 (2) To connect the wired remote control, the interface kit (SC-BIKN2-E) is required.

SRK15ZTL-W SRK20ZTL-W SRK25ZTL-W
SRK35ZTL-W SRK50ZTL-W

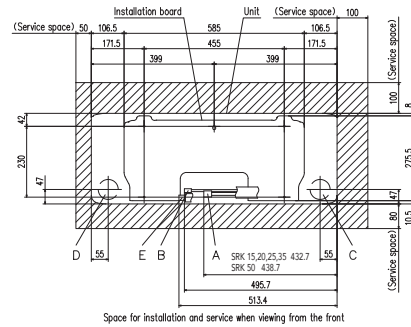
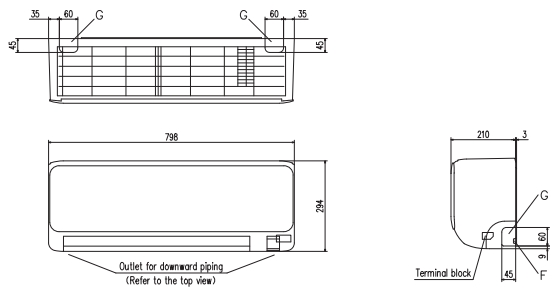

Space for installation and service when viewing from the front

Symbol	Content
A	Gas piping SRK 15, 20, 25, 35 ϕ 9.52 (3/8") (Flare) SRK 50 ϕ 12.7 (1/2") (Flare)
B	Liquid piping ϕ 6.35 (1/4") (Flare)
C	Hole on wall for right rear piping (ϕ 65)
D	Hole on wall for left rear piping (ϕ 65)
E	Drain hose VP16
F	Outlet for wiring (on both side)
G	Outlet for piping (on both side)

Notes (1) The model name label is attached on the underside of the indoor unit.
 (2) To connect the wired remote control, the interface kit (SC-BIKN2-E) is required.

SRK63ZTL-W
SRK71ZTL-W

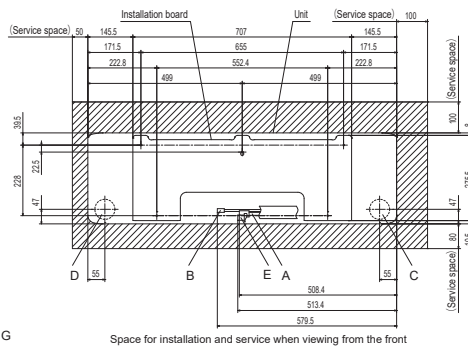
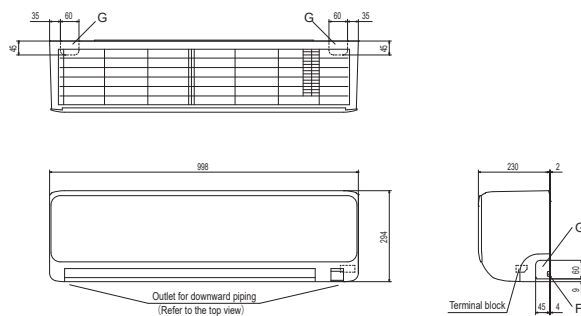

Space for installation and service when viewing from the front

Symbol	Content
A	Gas piping ϕ 12.7 (1/2") (Flare)
B	Liquid piping ϕ 6.35 (1/4") (Flare)
C	Hole on wall for right rear piping (ϕ 65)
D	Hole on wall for left rear piping (ϕ 65)
E	Drain hose VP16
F	Outlet for wiring (on both side)
G	Outlet for piping (on both side)

Notes (1) The model name label is attached on the underside of the indoor unit.
 (2) To connect the wired remote control, the interface kit (SC-BIKN2-E) is required.

DIMENSIONS (Unit: mm)

SRK25ZSP-W1 SRK35ZSP-W1 SRK45ZSP-W1 SRK50ZSP-W1 SKM15ZSP-W SKM20ZSP-W SKM25ZSP-W SKM35ZSP-W

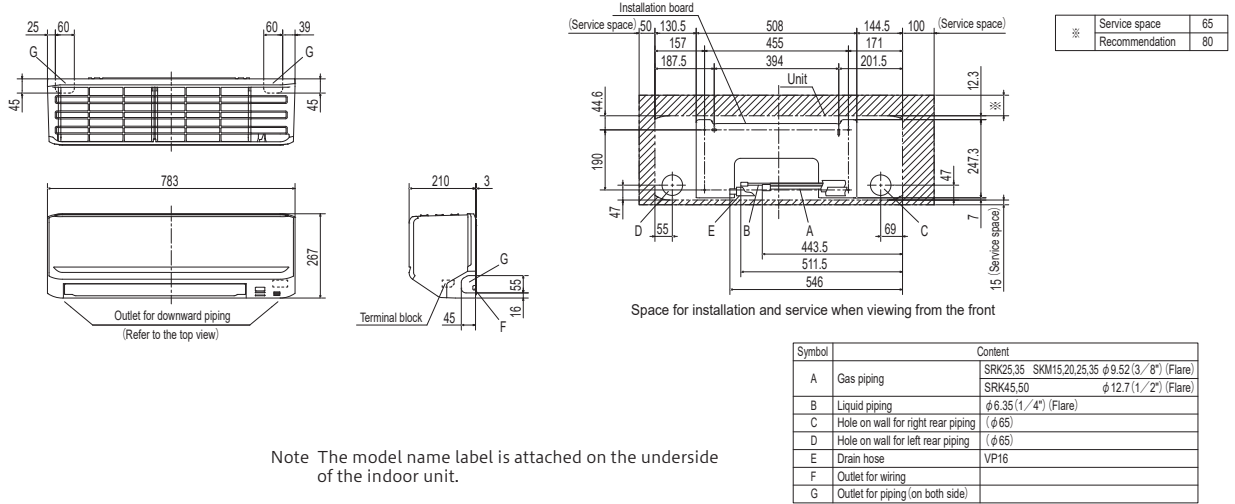

Note The model name label is attached on the underside of the indoor unit.

SRK25ZSP-S SRK35ZSP-S SRK45ZSP-S

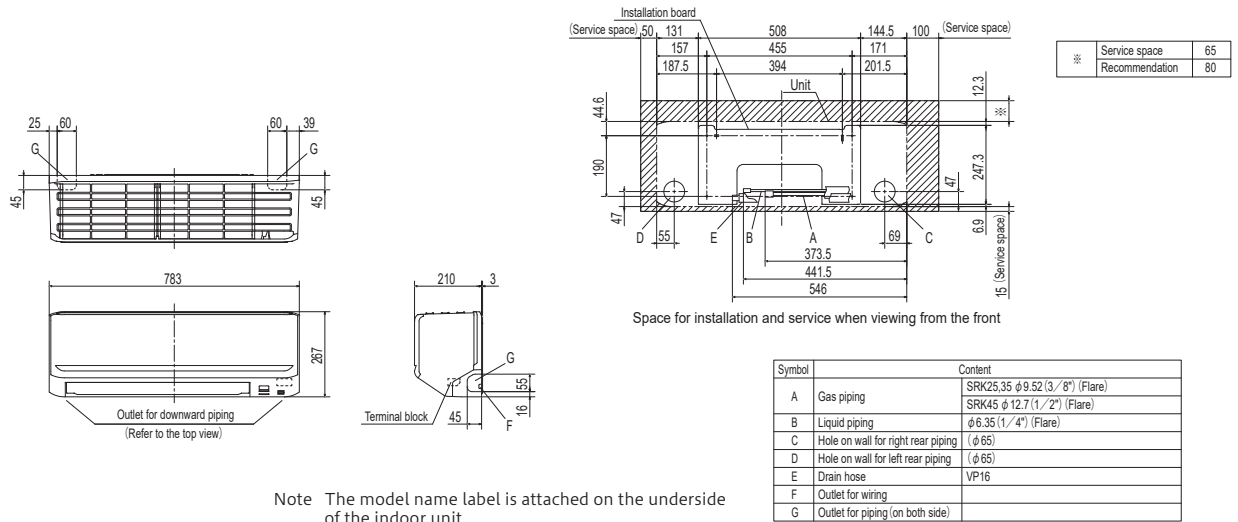

Note The model name label is attached on the underside of the indoor unit.

SRF25ZS-W SRF35ZS-W SRF50ZSX-W SRF25ZMX-S SRF35ZMX-S SRF50ZMX-S

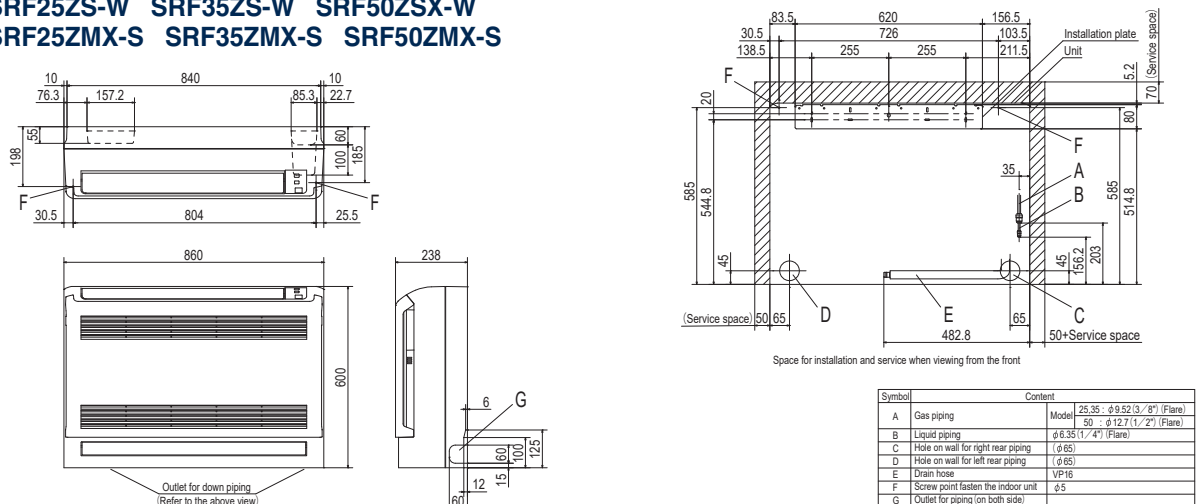

Notes

- (1) The model name label is attached on the rightside of the unit.
- (2) It takes the interface kit (SC-BIKN2-E) to connect the wired remote control.
- (3) In case of wall installation, leave the unit 150mm or less from the floor.

INDOOR UNIT

SRR25ZS-W SRR35ZS-W SRR25ZM-S SRR35ZM-S

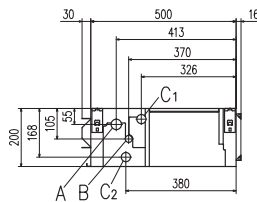
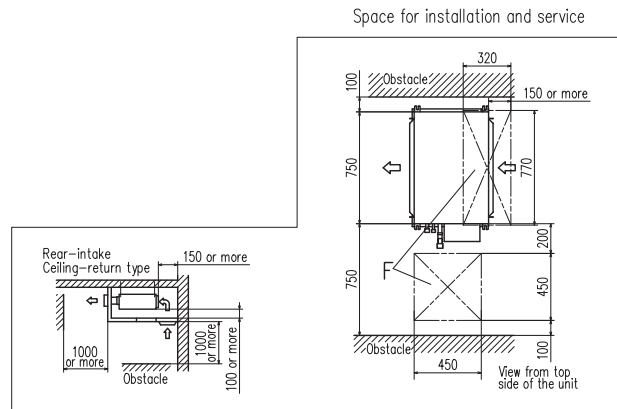
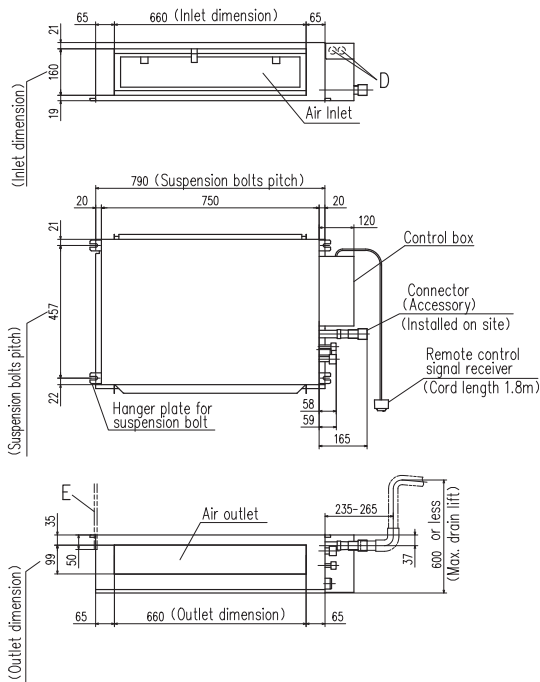

Symbol	Model	Content
	Model	25,35
A	Gas piping	φ9.52 (3/8") (Flare)
B	Liquid piping	φ6.35 (1/4") (Flare)
C1	Drain piping	VP25 (I.D.25, O.D.32)
C2	Drain piping (Gravity drainage)	VP25 (I.D.25, O.D.32) (Used with attached connector)
D	Hole for wiring	φ25 x 2
E	Suspension bolts	(M10)
F	Inspection hole	(450X450), (320X770)

Notes

- (1) The model name label is attached on the lid of the control box.
- (2) It takes the interface kit (SC-BIKN2-E) to connect the wired remote control.

SRR50ZS-W SRR60ZS-W

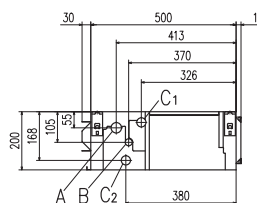
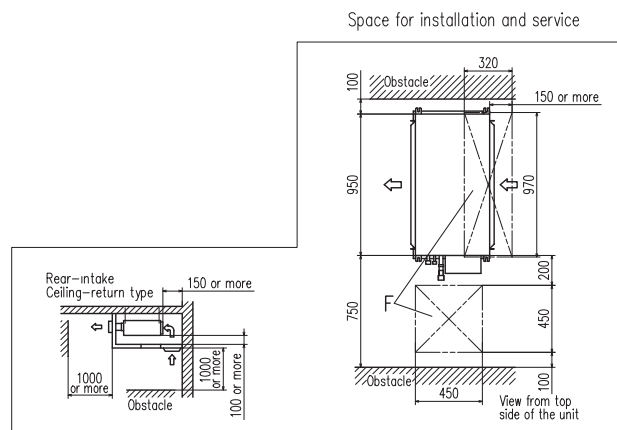
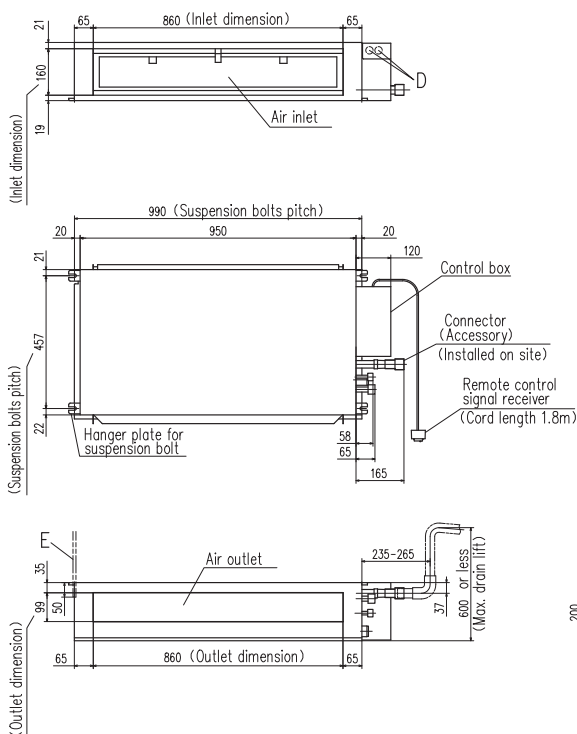

Symbol	Model	Content
	Model	50,60
A	Gas piping	φ12.7 (1/2") (Flare)
B	Liquid piping	φ6.35 (1/4") (Flare)
C1	Drain piping	VP25 (I.D.25, O.D.32)
C2	Drain piping (Gravity drainage)	VP25 (I.D.25, O.D.32) (Used with attached connector)
D	Hole for wiring	φ25 x 2
E	Suspension bolts	(M10)
F	Inspection hole	(450X450), (320X970)

Notes

- (1) The model name label is attached on the lid of the control box.
- (2) It takes the interface kit (SC-BIKN2-E) to connect the wired remote control.

DIMENSIONS (Unit: mm)

FDTC25VH1 FDTC35VH1 FDTC40VH FDTC50VH FDTC60VH

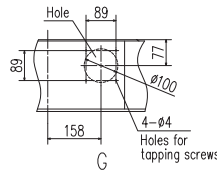
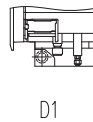
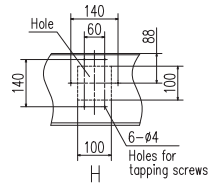
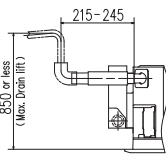
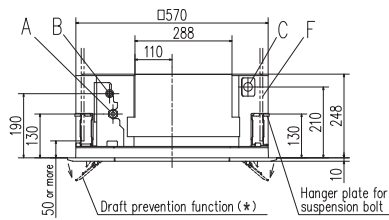
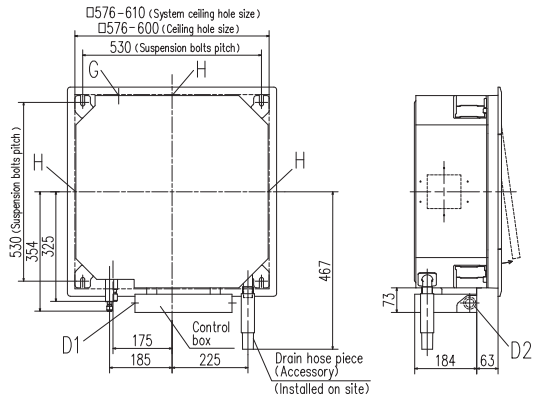

- Notes (1) The model name label is attached to the control box lid.
 (2) This unit is designed for 2x2 grid ceiling.
 If it is installed on a ceiling other than 2x2 grid ceiling, provide an inspection opening on the control box side.
 (3) Draft prevention function (*) is provided on the panel TC-PSA(G)E-5AW-E only.

Symbol	Content
A	Gas piping 25.35 - $\phi 9.52$ (3/8") (Flare)
B	Liquid piping 40-60 - $\phi 12.7$ (1/2") (Flare)
C	Drain piping $\phi 6.35$ (1/4") (Flare)
D1	Power supply connection VP25 (O.D.32)
D2	Remote control code and signal wiring connection
F	Suspension bolts (M10 or M8)
G	Outside air opening for ducting (Knock out)
H	Air outlet opening for ducting $\phi 125$ (Knock out)
J	Inspection opening 450x450

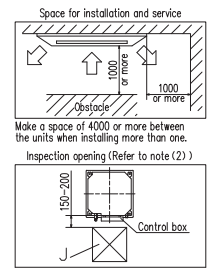

FDTC25VF FDTC35VF FDTC40VF FDTC50VF FDTC60VF

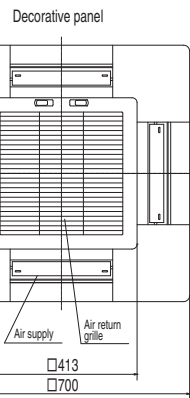
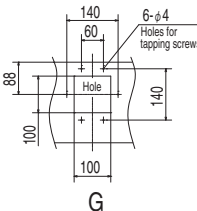
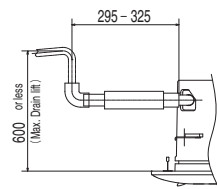
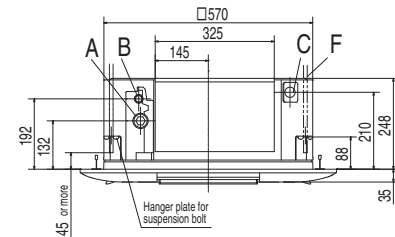
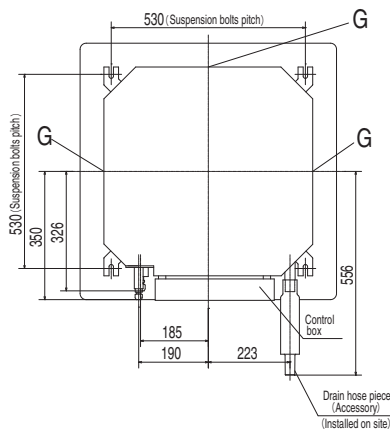

Symbol	Content
A	Gas piping 25.35 - $\phi 9.52$ (3/8") (Flare)
B	Liquid piping 40-60 - $\phi 12.7$ (1/2") (Flare)
C	Drain piping VP20 (I.D.20, O.D.26) Note (2)
D	Hole for wiring $\phi 25$
F	Suspension bolts (M10 or M8)
G	Air outlet opening for ducting (Knock out)

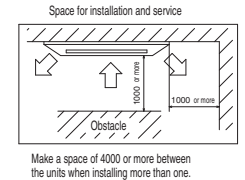

- Notes (1) The model name label is attached on the control box lid.
 (2) Prepare the connecting socket (VP20) on site.
 (3) This unit is designed for 2x2 grid ceiling.
 If it is installed on a ceiling other than 2x2 grid ceiling, provide an inspection port on the control box side.

INDOOR UNIT

FDUM50VH

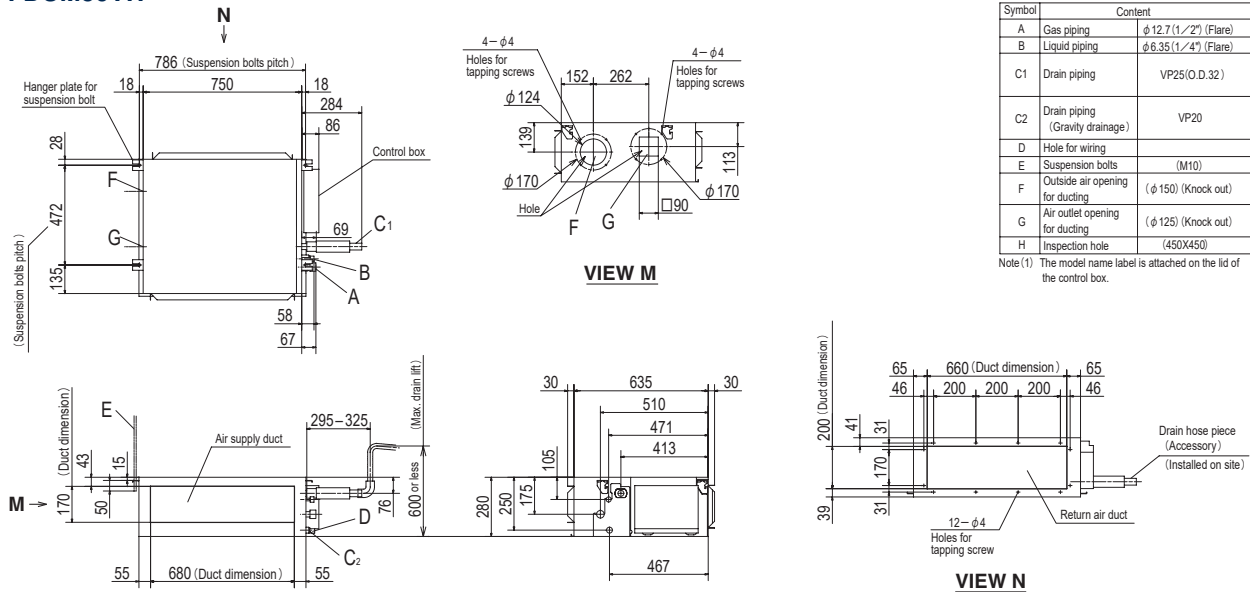

Symbol	Content
A	Gas piping $\phi 12.7 (1/2")$ (Flare)
B	Liquid piping $\phi 6.35 (1/4")$ (Flare)
C1	Drain piping VP25(O.D.32)
C2	Drain piping (Gravity drainage) VP20
D	Hole for wiring
E	Suspension bolts (M10)
F	Outside air opening for ducting ($\phi 150$) (Knock out)
G	Air outlet opening for ducting ($\phi 125$) (Knock out)
H	Inspection hole (450X450)

Note (1) The model name label is attached on the lid of the control box.

Space for installation and service

Select either of two cases to keep space for installation and services.

(Case 1) From side of unit

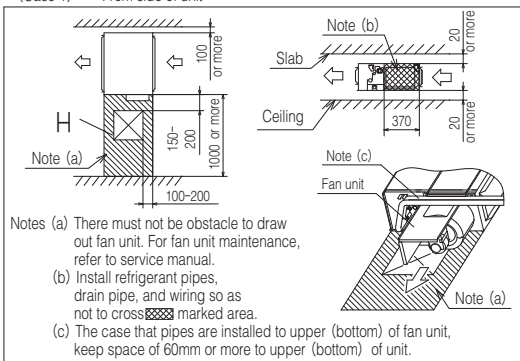

(Case 2) From bottom of unit

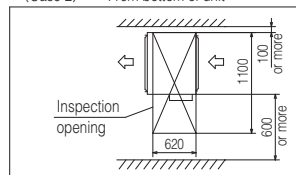

FDE50VH

Symbol	Content
A	Gas piping $\phi 12.7 (1/2")$ (Flare)
B	Liquid piping $\phi 6.35 (1/4")$ (Flare)
C 1,2	Drain piping VP20
D	Hole for suspension bolt (M10 or M8)
E	Back cutout PE cover
F	Top cutout Plate cover
G	Hole for drain piping (for left back) (Knock out)

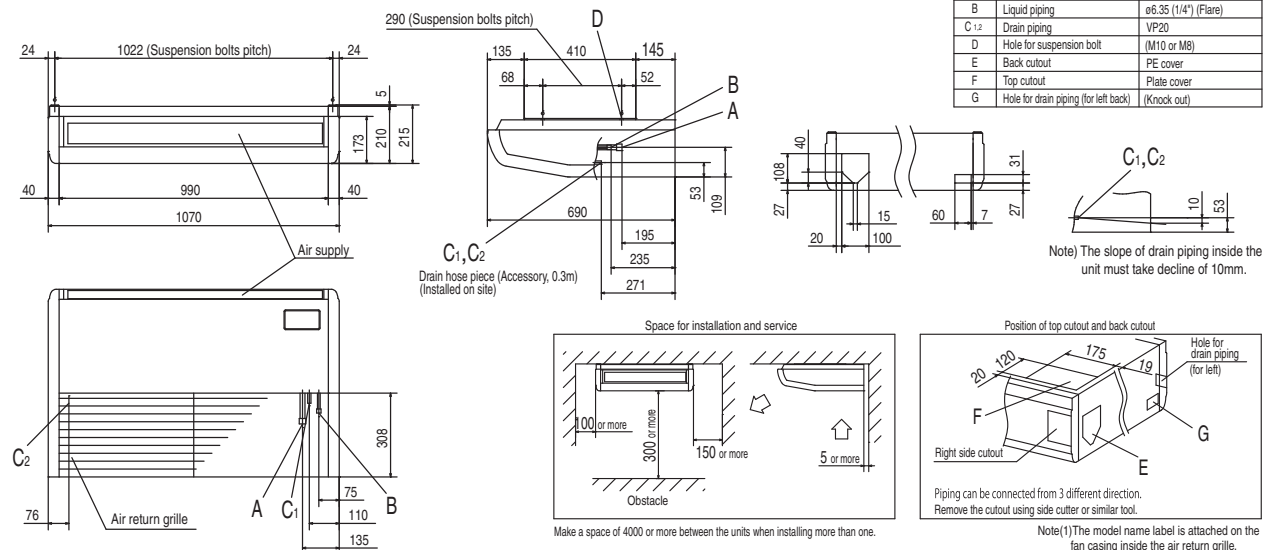

Make a space of 4000 or more between the units when installing more than one.

Note (1) The model name label is attached on the fan casing inside the air return grille.

DIMENSIONS (Unit: mm)

SRC20ZSX-W,-S SRC25ZSX-W,-S SRC35ZSX-W,-S SRC40ZSX-W1,-S SRC50ZSX-W3,-W2,-S SRC60ZSX-W3,-W1,-S SRC63ZR-W,-S SRC63ZTL-W SRC71ZTL-W

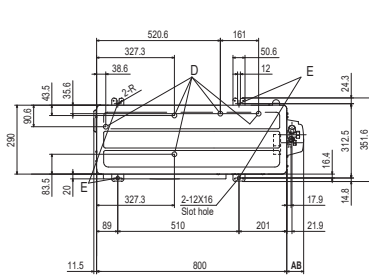

Symbol	Content	
A	Service valve connection (gas side)	20,25,35 ϕ 9.52(3/8") (Flare) 40,50,60,63,71 ϕ 12.7(1/2") (Flare)
B	Service valve connection (liquid side)	ϕ 6.35 (1/4") (Flare)
C	Pipe/cable draw-out hole	
D	Drain discharge hole	ϕ 20x5places
E	Anchor bolt hole	M10-12x4places

Examples of installation Dimensions	Minimum installation space			
	I	II	III	IV
L1	Open	280	280	180
L2	100	75	Open	Open
L3	100	80	80	80
L4	250	Open	250	Open

	AA	AB
ZSX	93	71.2
ZR	94.5	71
ZTL	94.5	71

Notes

- (1) The unit must not be surrounded by walls on the four sides.
- (2) The unit must be fixed with anchor bolts. An anchor bolt must not protrude more than 15mm.
- (3) If the unit is installed in the location where there is a possibility of strong winds, place the unit such that the direction of air from the outlet gets perpendicular to the wind direction.
- (4) Leave 200mm or more space above the unit.
- (5) The wall height on the outlet side should be 1200mm or less.
- (6) The model name label is attached on the right side of the unit.

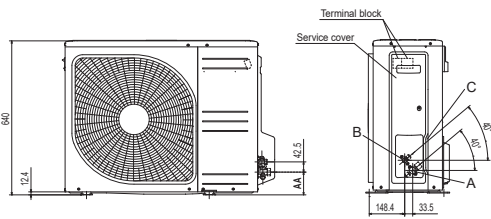

* The ZSX / ZR series does not have fin guard.

SRC50ZT-W, -WB

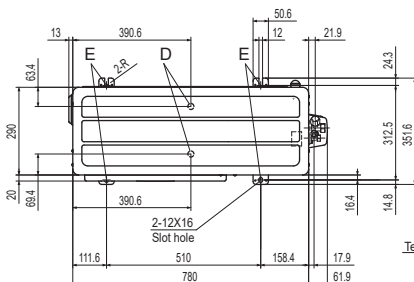

Symbol	Content	
A	Service valve connection (gas side)	ϕ 12.7 (1/2") (Flare)
B	Service valve connection (liquid side)	ϕ 6.35 (1/4") (Flare)
C	Pipe/cable draw-out hole	
D	Drain discharge hole	ϕ 20 x 2 places
E	Anchor bolt hole	M10-12 x 4 places

Installation space	
L1	280 or more
L2	100 or more
L3	80 or more
L4	250 or more

Notes

- (1) The unit must not be surrounded by walls on the four sides.
- (2) The unit must be fixed with anchor bolts. An anchor bolt must not protrude more than 15mm.
- (3) If the unit is installed in the location where there is a possibility of strong winds, place the unit such that the direction of air from the outlet gets perpendicular to the wind direction.
- (4) Leave 200mm or more space above the unit.
- (5) The wall height on the outlet side should be 1200mm or less.
- (6) The model name label is attached on the right side of the unit.

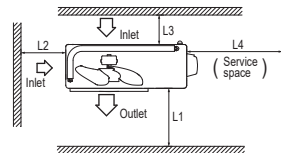
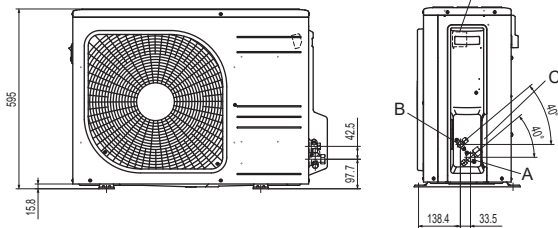

SRC50ZS-S SRC25ZMX-S SRC35ZMX-S SRC50ZTL-W SRC45ZSP-W1,-S SRC50ZSP-W1

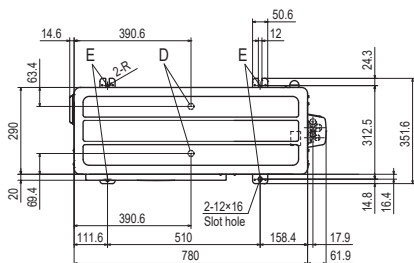

Symbol	Content	
A	Service valve connection (gas side)	ZMX: ϕ 9.52(3/8") (Flare) ZS,ZTL,ZSP: ϕ 12.7(1/2") (Flare)
B	Service valve connection (liquid side)	ϕ 6.35 (1/4") (Flare)
C	Pipe/cable draw-out hole	
D	Drain discharge hole	ϕ 20x2places
E	Anchor bolt hole	M10-12x4places

Installation space	
L1	280 or more
L2	100 or more
L3	80 or more
L4	250 or more

Notes

- (1) The unit must not be surrounded by walls on the four sides.
- (2) The unit must be fixed with anchor bolts. An anchor bolt must not protrude more than 15mm.
- (3) If the unit is installed in the location where there is a possibility of strong winds, place the unit such that the direction of air from the outlet gets perpendicular to the wind direction.
- (4) Leave 200mm or more space above the unit.
- (5) The wall height on the outlet side should be 1200mm or less.
- (6) The model name label is attached on the right side of the unit.

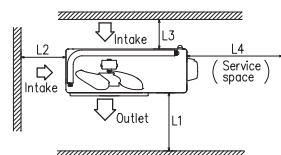
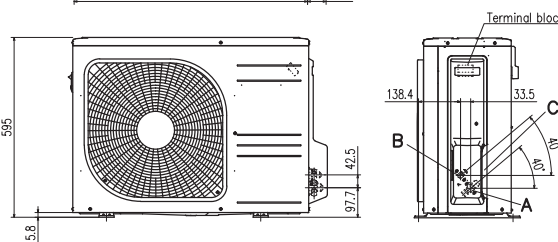

OUTDOOR UNIT

SRC20ZT-W , -WB SRC25ZT-W, -WB SRC35ZT-W, -WB

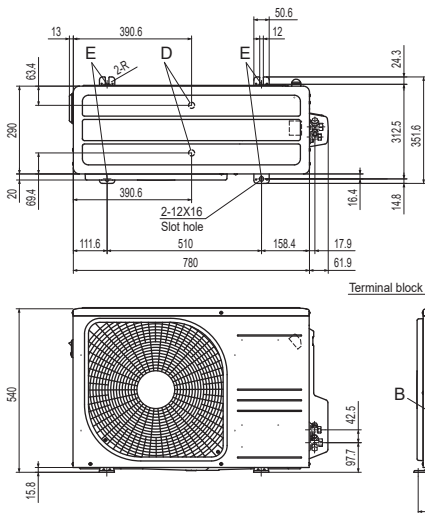

Symbol	Content	
A	Service valve connection (gas side)	φ9.52 (3/8") (Flare)
B	Service valve connection (liquid side)	φ6.35 (1/4") (Flare)
C	Pipe/cable draw-out hole	
D	Drain discharge hole	φ20 × 2 places
E	Anchor bolt hole	M10-12 × 4 places

	Installation space
L1	280 or more
L2	100 or more
L3	80 or more
L4	250 or more

Notes

- (1) The unit must not be surrounded by walls on the four sides.
- (2) The unit must be fixed with anchor bolts. An anchor bolt must not protrude more than 15mm.
- (3) If the unit is installed in the location where there is a possibility of strong winds, place the unit such that the direction of air from the outlet gets perpendicular to the wind direction.
- (4) Leave 200mm or more space above the unit.
- (5) The wall height on the outlet side should be 1200mm or less.
- (6) The model name label is attached on the right side of the unit.

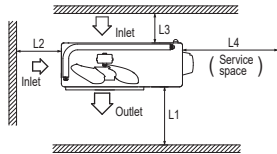

SRC20ZS-S SRC25ZS-W2, -S SRC35ZS-W2, -S

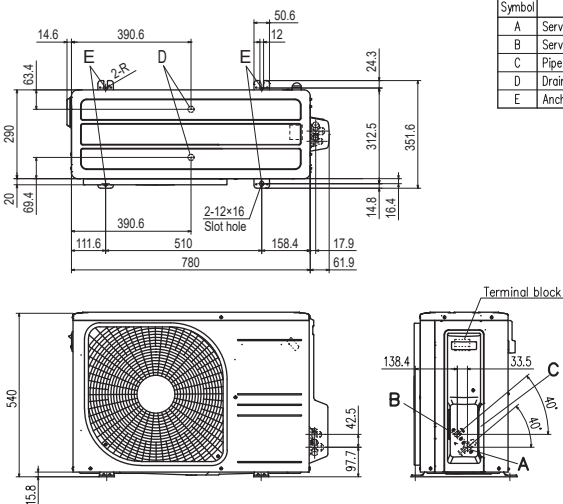

Symbol	Content	
A	Service valve connection (gas side)	φ9.52 (3/8") (Flare)
B	Service valve connection (liquid side)	φ6.35 (1/4") (Flare)
C	Pipe/cable draw-out hole	
D	Drain discharge hole	φ20×2places
E	Anchor bolt hole	M10-12×4places

	Installation space
L1	280 or more
L2	100 or more
L3	80 or more
L4	250 or more

Notes

- (1) The unit must not be surrounded by walls on the four sides.
- (2) The unit must be fixed with anchor bolts. An anchor bolt must not protrude more than 15mm.
- (3) If the unit is installed in the location where there is a possibility of strong winds, place the unit such that the direction of air from the outlet gets perpendicular to the wind direction.
- (4) Leave 200mm or more space above the unit.
- (5) The wall height on the outlet side should be 1200mm or less.
- (6) The model name label is attached on the right side of the unit.

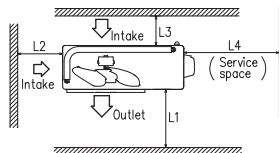

SRC15ZTL-W SRC20ZTL-W SRC25ZTL-W SRC35ZTL-W SRC25ZSP-W1, -S SRC35ZSP-W1, -S

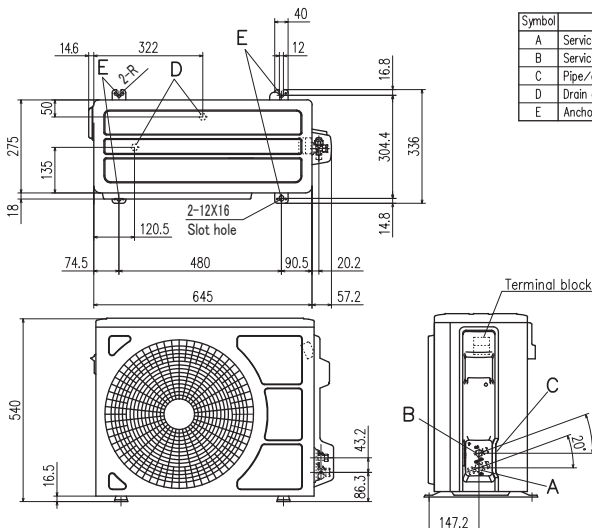

Symbol	Content	
A	Service valve connection (gas side)	φ9.52 (3/8") (Flare)
B	Service valve connection (liquid side)	φ6.35 (1/4") (Flare)
C	Pipe/cable draw-out hole	
D	Drain discharge hole	φ20×2places
E	Anchor bolt hole	M10-12×4places

	Installation space
L1	280 or more
L2	100 or more
L3	80 or more
L4	250 or more

Notes

- (1) The unit must not be surrounded by walls on the four sides.
- (2) The unit must be fixed with anchor bolts. An anchor bolt must not protrude more than 15mm.
- (3) If the unit is installed in the location where there is a possibility of strong winds, place the unit such that the direction of air from the outlet gets perpendicular to the wind direction.
- (4) Leave 200mm or more space above the unit.
- (5) The wall height on the outlet side should be 1200mm or less.
- (6) The model name label is attached on the right side of the unit.

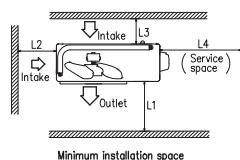

DIMENSIONS (Unit: mm)

SRC71ZR-W, -S SRC80ZR-W, -S

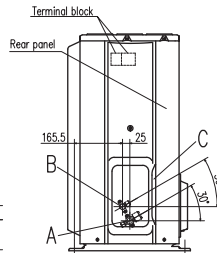
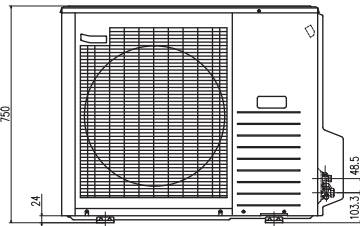
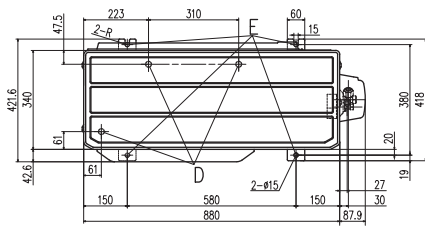

Symbol	Content
A	Service valve connection (gas side) $\phi 15.88$ (5/8") (Flare)
B	Service valve connection (liquid side) $\phi 6.35$ (1/4") (Flare)
C	Pipe/cable draw-out hole
D	Drain discharge hole $\phi 20 \times 3$ places
E	Anchor bolt hole M10 x 4 places

Examples of installation Dimensions	Minimum installation space		
	I	II	III
L1	Open	Open	500
L2	300	250	Open
L3	100	150	100
L4	250	250	250

Notes

- (1) It must not be surrounded by walls on four sides.
- (2) The unit must be fixed with anchor bolts. An anchor bolt must not protrude more than 15mm.
- (3) Where the unit is subjected to strong winds, lay it in such a direction that the blower outlet face is perpendicular to the dominant wind direction.
- (4) Leave 200mm or more space above the unit. (ZR-W)
Leave 1m or more space above the unit. (ZR-S)
- (5) The wall height on the outlet side should be 1200mm or less. (ZR-W)
A wall in front of the blower outlet must not exceed the unit's height. (ZR-S)
- (6) The model name label is attached on the rear panel.

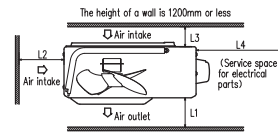

* The ZR-W / 71ZR-S series does not have fin guard.

FDC100VNP-W

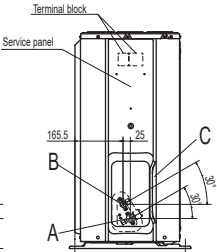
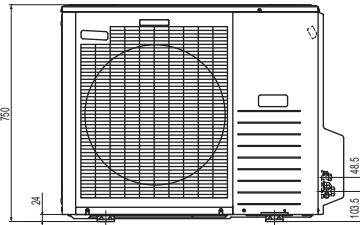
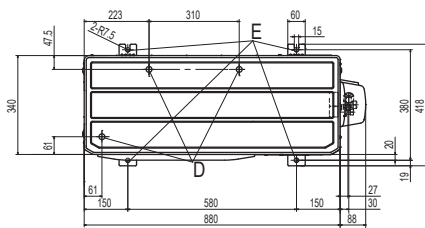

Symbol	Content
A	Service valve connection (gas side) $\phi 15.88$ (5/8") (Flare)
B	Service valve connection (liquid side) $\phi 6.35$ (1/4") (Flare)
C	Pipe/cable draw-out hole
D	Drain discharge hole $\phi 20 \times 3$ places
E	Anchor bolt hole M10 x 4 places

Examples of installation Dimensions	Minimum installation space		
	I	II	III
L1	Open	Open	500
L2	300	250	Open
L3	100	150	100
L4	250	250	250

Notes

- (1) It must not be surrounded by walls on four sides.
- (2) The unit must be fixed with anchor bolts. An anchor bolt must not protrude more than 15mm.
- (3) Where the unit is subjected to strong winds, lay it in such a direction that the blower outlet faces perpendicularly to the dominant wind direction.
- (4) Leave 1m or more space above the unit.
- (5) A wall in front of the blower outlet must not exceed the unit's height.
- (6) The model name label is attached on the lower right corner of the front panel.

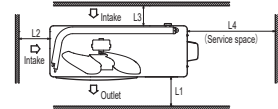

FDC100VNP

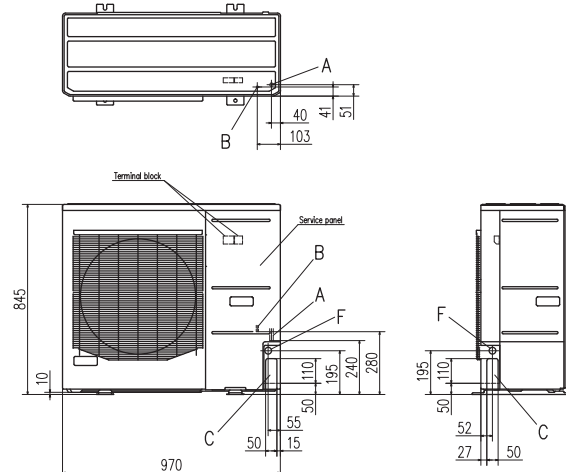

Symbol	Content
A	Service valve connection (gas side) $\phi 15.88$ (5/8") (Flare)
B	Service valve connection (liquid side) $\phi 9.52$ (3/8") (Flare)
C	Pipe/cable draw-out hole
D	Drain discharge hole $\phi 20 \times 3$ places
E	Anchor bolt hole M10 x 4 places
F	Cable draw-out hole $\phi 30 \times 3$ places

Notes

- (1) It must not be surrounded by walls on four sides.
- (2) The unit must be fixed with anchor bolts. An anchor bolt must not protrude more than 15mm.
- (3) Where the unit is subjected to strong winds, lay it in such a direction that the blower outlet face is perpendicular to the dominant wind direction.
- (4) Leave 1m or more space above the unit.
- (5) A wall in front of the blower outlet must not exceed the unit's height.
- (6) The model name label is attached on the service panel.

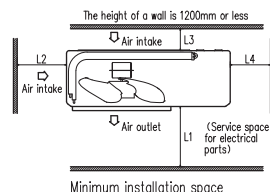
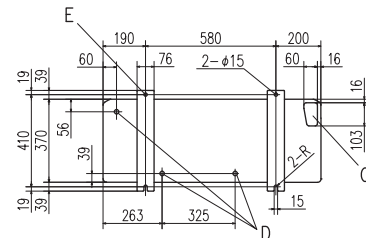

Examples of installation Dimensions	Minimum installation space		
	I	II	III
L1	Open	Open	500
L2	300	250	Open
L3	100	150	100
L4	250	250	250

OUTDOOR UNIT

SCM30ZS-W SCM40ZS-W,-S SCM45ZS-W,-S

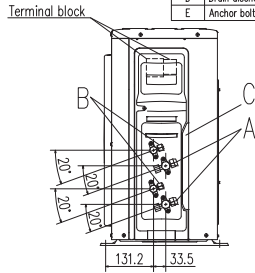
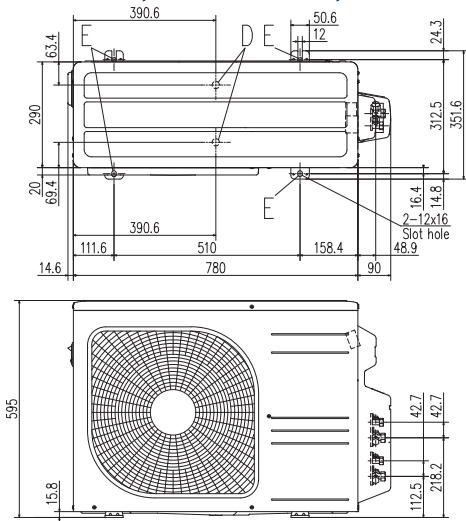

Notes

- (1) The unit must not be surrounded by walls on the four sides.
- (2) The unit must be fixed with anchor bolts. An anchor bolt must not protrude more than 15mm.
- (3) If the unit is installed in the location where there is a possibility of strong winds, place the unit such that the direction of air from the outlet gets perpendicular to the wind direction.
- (4) Leave 200mm or more space above the unit.
- (5) The wall height on the outlet side should be 1200mm or less.
- (6) The model name label is attached on the right side of the unit.

Symbol	Content
A	Service valve connection (gas side) $\phi 9.52$ (3/8") (Flare)
B	Service valve connection (liquid side) $\phi 6.35$ (1/4") (Flare)
C	Pipe / cable draw-out hole
D	Drain discharge hole $\phi 20 \times 2$ places
E	Anchor bolt hole M10-12x4 places

	Installation space
L1	280 or more
L2	100 or more
L3	80 or more
L4	250 or more

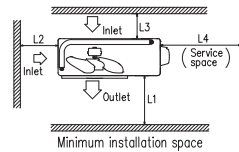

SCM41ZS-W SCM50ZS-W SCM60ZS-W SCM50ZS-S1 SCM60ZM-S1

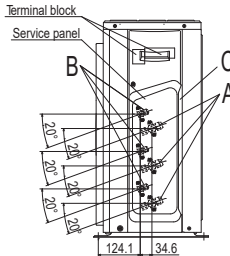
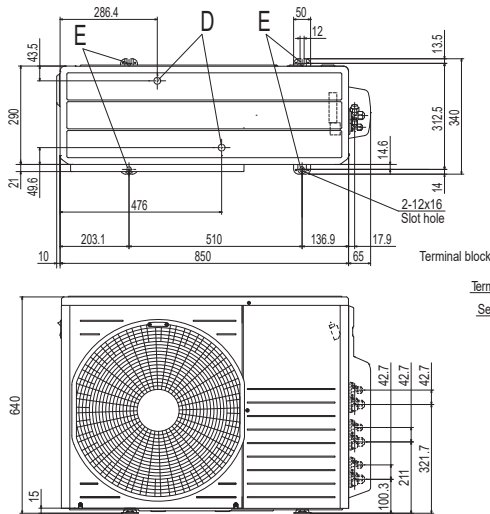

Notes

- (1) The unit must not be surrounded by walls on the four sides.
- (2) The unit must be fixed with anchor bolts. An anchor bolt must not protrude more than 15mm.
- (3) If the unit is installed in the location where there is a possibility of strong winds, place the unit such that the direction of air from the outlet gets perpendicular to the wind direction.
- (4) Leave 200mm or more space above the unit.
- (5) The wall height on the outlet side should be 1200mm or less.
- (6) The model name label is attached on the right side of the unit.

Symbol	Content
A	Service valve connection (gas side) $\phi 9.52$ (3/8") Flare
B	Service valve connection (liquid side) $\phi 6.35$ (1/4") Flare
C	Pipe / cable draw-out hole
D	Drain discharge hole $\phi 20 \times 3$ places
E	Anchor bolt hole M10-12 x 4 places

	Minimum installation space
L1	600 or more
L2	100 or more
L3	100 or more
L4	No obstacles (Service space or electrical parts)

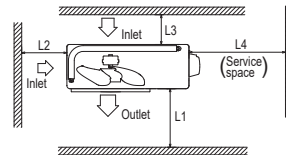

SCM71ZS-W SCM80ZS-W SCM71ZM-S1 SCM80ZM-S1

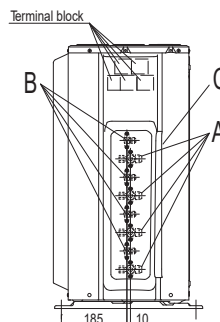
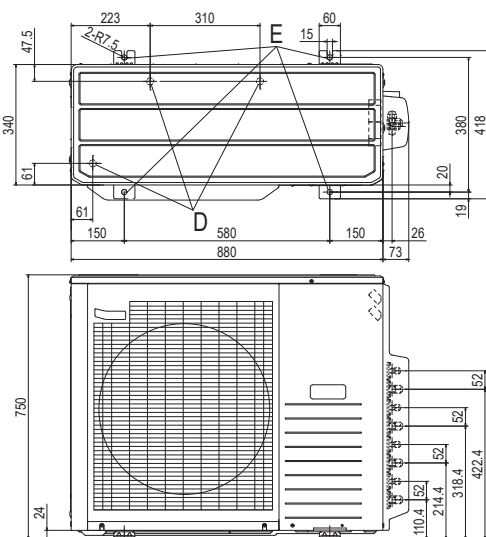

Notes

- (1) It must not be surrounded by walls on four sides.
- (2) The unit must be fixed with anchor bolts. An anchor bolt must not protrude more than 15mm.
- (3) Where the unit is subjected to strong winds, lay it in such a direction that the blower outlet faces perpendicularly to the dominant wind direction.
- (4) Leave 1.2m or more space above the unit.
- (5) A wall in front of the blower outlet must not exceed the unit's height.
- (6) The model name label is attached on the rear panel.

Symbol	Content
A	Service valve connection (gas side) $\phi 9.52$ (3/8") Flare
B	Service valve connection (liquid side) $\phi 6.35$ (1/4") Flare
C	Pipe / cable draw-out hole
D	Drain discharge hole $\phi 20 \times 3$ places
E	Anchor bolt hole M10 x 4 places

Minimum installation space

Examples of installation Dimensions	Minimum installation space		
	I	II	III
L1	Open	Open	500
L2	300	250	Open
L3	100	150	100
L4	250	250	250

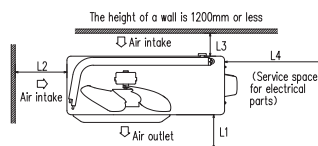

DIMENSIONS (Unit: mm)

OUTDOOR UNIT

SCM100ZS-W SCM100ZM-S

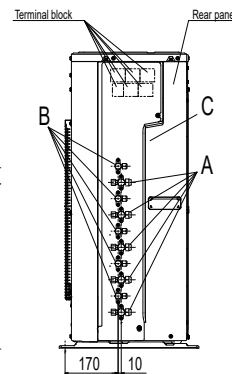
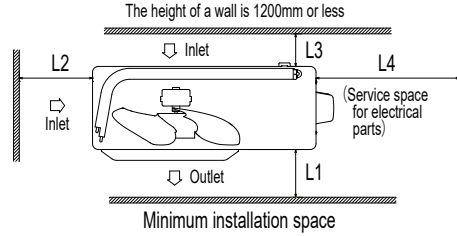
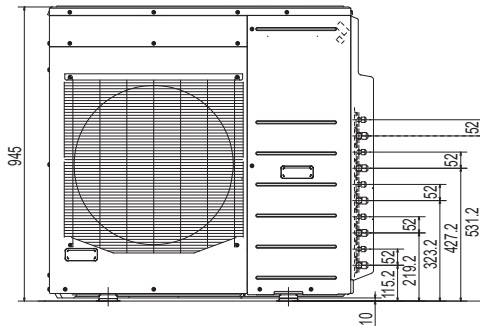
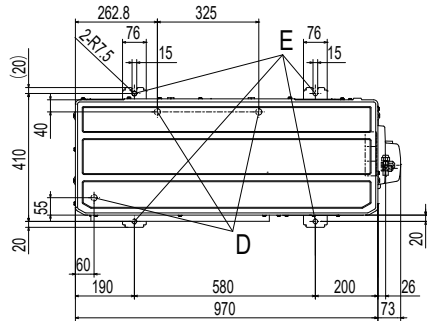

Symbol	Content	
A	Service valve connection (gas side)	φ9.52 (3/8") (Flare)
B	Service valve connection (liquid side)	φ6.35 (1/4") (Flare)
C	Pipe/cable draw-out hole	
D	Drain discharge hole	φ20 × 3places
E	Anchor bolt hole	M10-12 × 4places

Notes

- (1) It must not be surrounded by walls on four sides.
- (2) The unit must be fixed with anchor bolts. An anchor bolt must not protrude more than 15mm.
- (3) Where the unit is subjected to strong winds, lay it in such a direction that the blower outlet faces perpendicularly to the dominant wind direction.
- (4) Leave 1.2m or more space above the unit.
- (5) A wall in front of the blower outlet must not exceed the unit's height.

Examples of installation Dimensions	Content		
	I	II	III
L1	Open	Open	500
L2	300	5	Open
L3	150	300	150
L4	250	250	250

SCM125ZM-S

Symbol	Content	
A	Service valve connection (gas side)	φ9.52 (3/8") (Flare)
B	Service valve connection (liquid side)	φ6.35 (1/4") (Flare)
C	Pipe/cable draw-out hole	
D	Drain discharge hole	φ20×3places
E	Anchor bolt hole	M10×4places

Notes

- (1) It must not be surrounded by walls on the four sides.
- (2) The unit must be fixed with anchor bolts. An anchor bolt must not protrude more than 15mm.
- (3) Where the unit is subject to strong winds, lay it in such a direction that the blower outlet faces perpendicularly to the dominant wind direction.
- (4) Leave 1m or more space above the unit.
- (5) A wall in front of the blower outlet must not exceed the unit's height.
- (6) The model name label is attached on the rear panel.

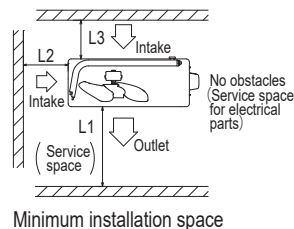
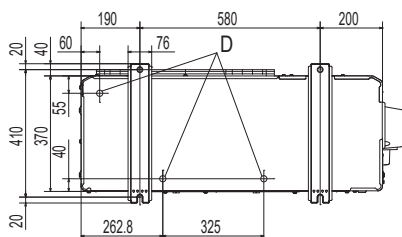
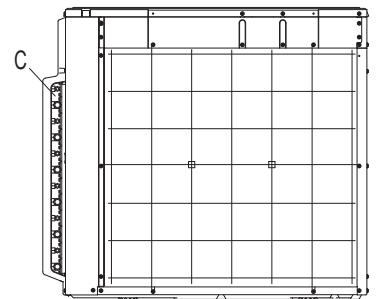
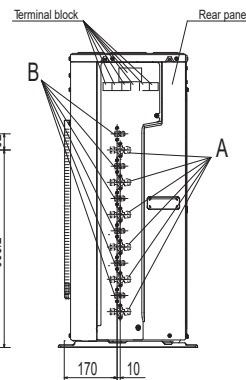
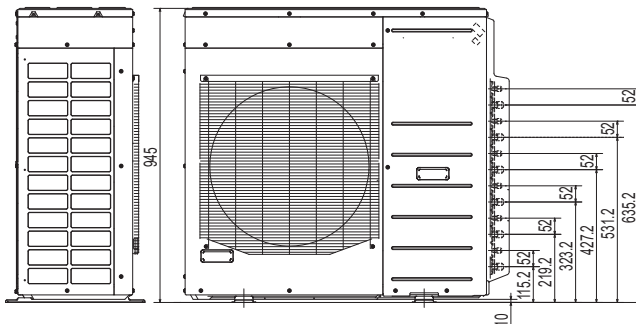
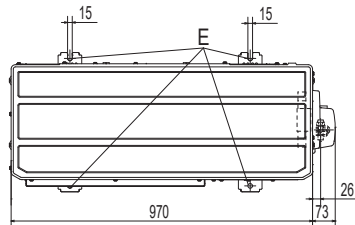

Examples of installation Dimensions	Content		
	I	II	III
L1	Open	Open	500
L2	300	5	Open
L3	150	300	150

ENERGY EFFICIENT AND ENVIRONMENTALLY CONSCIOUS

ENERGY LABEL – FOR EU/EEA AREA ONLY –

SEER and SCOP is defined in European regulations listed below.

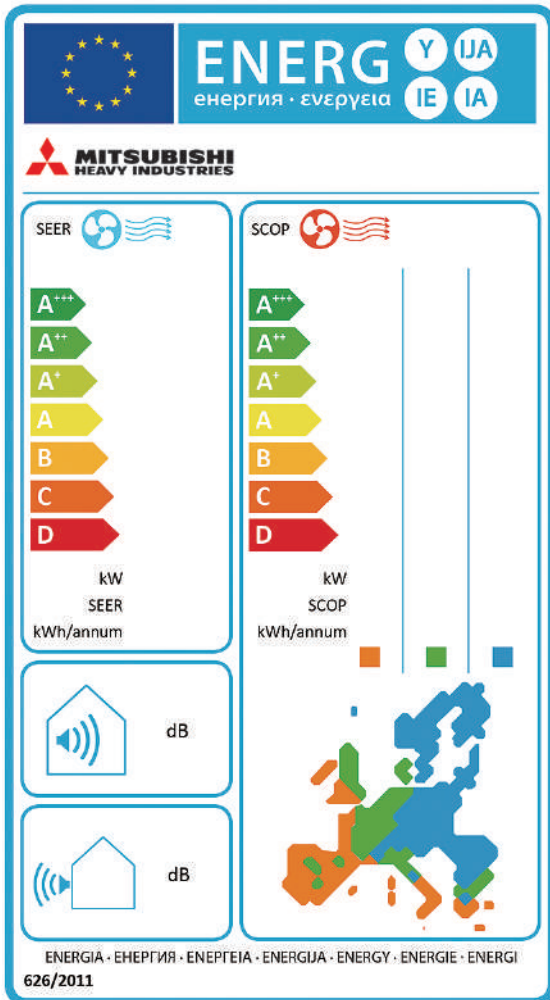

No.626/2011 of 4 May 2011:
energy labeling of air-conditioners
(below cooling capacity 12kW).

No.206/2012 of 6 March 2012: requirement for air-conditioners
and comfort fans.

Seasonal efficiency is the method of rating the true efficiency of
heating and cooling products over an entire year.

Set by the EU's new regulation implementing Eco-Design
Directive for Energy related Product (ErP) which specifies the
minimum efficiency of air-conditioners manufacturers must
integrate into their products.

The Seasonal Efficiency rating system that must be used for
heating and cooling by all manufacturers are;

SEER - Seasonal Efficiency Ratio (value in cooling)

SCOP - Seasonal Coefficient of Performance (value in heating)

The rating system will indicate the true efficiency of the energy
using product at specified condition.

Employment of lead-free solder

Adapted to RoHS directive

RoHS:Restriction of Hazardous substances

In order to avoid the release of hazardous substances into
the environment, all models have utilised lead-free solder
application. It has been considered to be difficult to use lead-
free solder for practical applications because it requires higher
solder temperatures at assembly, which can jeopardize reliability.
However our PbF soldering method can produce a higher quality
lead-free printed circuit board.

Employment of **R32** **R410A**

All models use refrigerant R32 or R410A characterized by the
ozone depletion coefficient being 0.

Excellent Energy Saving

High performance and excellent energy savings are achieved
at the same time by heat exchanger's increased capacity and
employment of high efficiency DC motor.

ENERGY EFFICIENT AND ENVIRONMENTALLY CONSCIOUS

Based on European regulations listed below, please refer the following specification table.

– Single-split –

Indoor unit		SRK20ZSX-WF*1	SRK25ZSX-WF*1	SRK35ZSX-WF*1	SRK50ZSX-WF*1	SRK60ZSX-WF*1	SRK20ZSX-W	SRK25ZSX-W
Outdoor unit		SRC20ZSX-W	SRC25ZSX-W	SRC35ZSX-W	SRC50ZSX-W2,-W3	SRC60ZSX-W1,-W3	SRC20ZSX-W	SRC25ZSX-W
Energy class (cooling/heating)		A+++/A+++	A+++/A+++	A+++/A+++	A++/A++	A++/A++	A+++/A+++	A+++/A+++
SEER		10.00	10.30	9.50	8.30	7.80	10.00	10.30
SCOP (Average climate)		5.20	5.20	5.10	4.70	4.70	5.20	5.20
Pdesign (cooling/heating(@-10°C))	kW	2.00/2.80	2.50/3.00	3.50/3.40	5.00/4.50	6.10/5.20	2.00/2.80	2.50/3.00
Annual electricity consumption (cooling/heating)	kWh/a	70/754	85/808	129/934	211/1341	274/1551	70/754	85/808
Designated heating season		Average						
Indoor unit		SRK35ZSX-W	SRK50ZSX-W	SRK60ZSX-W	SRK63ZR-WF	SRK71ZR-WF	SRK80ZR-WF	SRK100ZR-WF
Outdoor unit		SRC35ZSX-W	SRC50ZSX-W2,-W3	SRC60ZSX-W1,-W3	SRC63ZR-W	SRC71ZR-W	SRC80ZR-W	FDC100VNP-W
Energy class (cooling/heating)		A+++/A+++	A++/A++	A++/A++	A++/A++	A++/A+	A++/A+	A++/A+
SEER		9.50	8.30	7.80	8.10	7.40	7.00	6.11
SCOP (Average climate)		5.10	4.70	4.70	4.70	4.50	4.40	4.14
Pdesign (cooling/heating(@-10°C))	kW	3.50/3.40	5.00/4.50	6.10/5.20	6.30/5.40	7.10/6.60	8.00/7.10	9.6/6.0
Annual electricity consumption (cooling/heating)	kWh/a	129/934	211/1341	274/1551	273/1608	337/2055	401/2259	551/2028
Designated heating season		Average						
Indoor unit		SRK63ZR-W	SRK71ZR-W	SRK80ZR-W	SRK100ZR-W	SRK20ZT-WF*1	SRK25ZT-WF*1	SRK35ZT-WF*1
Outdoor unit		SRC63ZR-W	SRC71ZR-W	SRC80ZR-W	FDC100VNP-W	SRC20ZT-W*1	SRC25ZT-W*1	SRC35ZT-W*1
Energy class (cooling/heating)		A++/A++	A++/A+	A++/A+	A++/A+	A+++/A+++	A+++/A+++	A+++/A+++
SEER		8.10	7.40	7.00	6.11	9.50	9.50	8.70
SCOP (Average climate)		4.70	4.50	4.40	4.14	5.10	5.10	4.90
Pdesign (cooling/heating(@-10°C))	kW	6.30/5.40	7.10/6.60	8.00/7.10	9.6/6.0	2.00/2.60	2.50/2.70	3.50/3.00
Annual electricity consumption (cooling/heating)	kWh/a	273/1608	337/2055	401/2259	551/2028	74/714	93/741	141/858
Designated heating season		Average						
Indoor unit		SRK50ZT-WF*1	SRK15ZTL-W	SRK20ZTL-W	SRK25ZTL-W	SRK35ZTL-W	SRK50ZTL-W	SRK63ZTL-W
Outdoor unit		SRC50ZT-W*1	SRC15ZTL-W	SRC20ZTL-W	SRC25ZTL-W	SRC35ZTL-W	SRC50ZTL-W	SRC63ZTL-W
Energy class (cooling/heating)		A+++/A+++	A++/A+	A++/A+	A++/A++	A++/A++	A++/A+	A++/A++
SEER		7.50	6.40	6.70	6.90	6.50	6.50	7.50
SCOP (Average climate)		4.70	4.40	4.40	4.70	4.70	4.30	4.60
Pdesign (cooling/heating(@-10°C))	kW	5.00/3.80	1.50/2.30	2.00/2.40	2.50/2.70	3.50/2.80	5.00/4.00	6.30/5.30
Annual electricity consumption (cooling/heating)	kWh/a	234/1133	83/732	105/764	127/804	189/835	270/1302	295/1615
Designated heating season		Average						
Indoor unit		SRK71ZTL-W	SRK25ZSP-W1	SRK35ZSP-W1	SRK45ZSP-W1	SRK50ZSP-W1	SRF25ZS-W	SRF35ZS-W
Outdoor unit		SRC71ZTL-W	SRC25ZSP-W1	SRC35ZSP-W1	SRC45ZSP-W1	SRC50ZSP-W1	SRC25ZS-W2	SRC35ZS-W2
Energy class (cooling/heating)		A++/A+	A++/A+	A++/A+	A++/A+	A++/A+	A++/A+	A++/A++
SEER		7.10	6.90	7.30	6.40	6.30	7.40	8.10
SCOP (Average climate)		4.40	4.10	4.50	4.20	4.20	4.00	4.70
Pdesign (cooling/heating(@-10°C))	kW	7.10/6.20	2.50/2.70	3.20/2.80	4.50/3.80	5.00/3.80	2.50/2.40	3.50/2.90
Annual electricity consumption (cooling/heating)	kWh/a	351/1972	127/923	154/872	247/1266	278/1266	119/840	152/864
Designated heating season		Average						
Indoor unit		SRF50ZSX-W	SRR25ZS-W	SRR35ZS-W	SRR50ZS-W	SRR60ZS-W	FDTC25VH1	FDTC35VH1
Outdoor unit		SRC50ZSX-W2,-W3	SRC25ZS-W2	SRC35ZS-W2	SRC50ZSX-W3	SRC60ZSX-W3	SRC25ZS-W2	SRC35ZS-W2
Energy class (cooling/heating)		A+++/A+++	A++/A+	A++/A+	A++/A+	A++/A+	A++/A+	A++/A++
SEER		7.50	6.60	6.80	6.50	6.20	6.80	7.10
SCOP (Average climate)		4.60	4.10	4.50	4.40	4.30	4.00	4.60
Pdesign (cooling/heating(@-10°C))	kW	5.00/4.10	2.50/2.50	3.50/3.10	5.00/4.50	5.60/5.20	2.50/2.40	3.50/2.90
Annual electricity consumption (cooling/heating)	kWh/a	234/1247	133/853	181/966	270/1431	316/1692	129/840	173/883
Designated heating season		Average						
Indoor unit		FDTC40VH	FDTC50VH	FDTC60VH	SRK20ZSX-S	SRK25ZSX-S	SRK35ZSX-S	SRK50ZSX-S
Outdoor unit		SRC40ZSX-W1	SRC50ZSX-W2,-W3	SRC60ZSX-W1,-W3	SRC20ZSX-S	SRC25ZSX-S	SRC35ZSX-S	SRC50ZSX-S
Energy class (cooling/heating)		A++/A+	A++/A+	A++/A+	A+++/A+++	A+++/A+++	A+++/A+++	A++/A++
SEER		6.94	6.52	6.45	9.50	9.60	9.20	8.20
SCOP (Average climate)		4.37	4.30	4.10	5.20	5.20	5.10	4.70
Pdesign (cooling/heating(@-10°C))	kW	4.0/4.0	5.0/4.3	5.6/5.1	2.00/2.70	2.50/2.90	3.50/3.30	5.00/4.50
Annual electricity consumption (cooling/heating)	kWh/a	202/1283	269/1401	304/1744	74/728	92/781	134/906	214/1341
Designated heating season		Average						

*1 The colour variation type has the same value.

*SEER/SCOP are based on EN14825:2016 and Commission regulation (EU) No.2016/2281. Temperature conditions for calculating SCOP are based on "Average climate".

Indoor unit		SRK60ZSX-S	SRK63ZR-S	SRK71ZR-S	SRK80ZR-S	SRK100ZR-S	SRK20ZS-S ¹	SRK25ZS-S ¹
Outdoor unit		SRC60ZSX-S	SRC63ZR-S	SRC71ZR-S	SRC80ZR-S	FDC100VNP	SRC20ZS-S	SRC25ZS-S
Energy class (cooling/heating)		A++/A++	A++/A++	A++/A+	A++/A+	A++/A+	A++/A++	A++/A++
SEER		7.60	7.60	7.20	6.60	6.60	7.80	7.80
SCOP (Average climate)		4.70	4.70	4.50	4.40	4.40	4.60	4.60
Pdesign (cooling/heating(@-10°C))	kW	6.10/5.20	6.30/5.40	7.10/6.60	8.00/7.10	10.0/7.20	2.00/2.40	2.50/2.50
Annual electricity consumption (cooling/heating)	kWh/a	282/1551	291/1610	346/2055	425/2261	531/2289	90/732	113/762
Designated heating season		Average						

Indoor unit		SRK35ZS-S ¹	SRK50ZS-S ¹	SRK25ZSP-S	SRK35ZSP-S	SRK45ZSP-S	SRF25ZMX-S	SRF35ZMX-S
Outdoor unit		SRC35ZSX-S	SRC50ZS-S	SRC25ZSP-S	SRC35ZSP-S	SRC45ZSP-S	SRC25ZMX-S	SRC35ZMX-S
Energy class (cooling/heating)		A++/A++	A++/A+	A/A	A++/A+	A/A	A++/A+	A++/A+
SEER		7.80	6.26	5.50	6.15	5.38	7.11	6.75
SCOP (Average climate)		4.60	4.20	3.80	4.00	3.81	4.37	4.26
Pdesign (cooling/heating(@-10°C))	kW	3.50/2.80	5.00/3.90	2.50/2.80	3.20/3.00	4.50/3.80	2.50/3.00	3.50/3.30
Annual electricity consumption (cooling/heating)	kWh/a	158/852	280/1300	160/1033	183/1052	293/1398	123/961	182/1085
Designated heating season		Average						

Indoor unit		SRF50ZMX-S	SRR25ZM-S	SRR35ZM-S	FDTC25VF	FDTC35VF	FDTC40VF	FDTC50VF
Outdoor unit		SRC50ZSX-S	SRC25ZMX-S	SRC35ZMX-S	SRC25ZMX-S	SRC35ZMX-S	SRC40ZSX-S	SRC50ZSX-S
Energy class (cooling/heating)		A++/A	A++/A+	A++/A+	A++/A+	A++/A+	A++/A	A+/A
SEER		6.12	6.43	6.33	6.10	6.12	6.53	6.01
SCOP (Average climate)		3.87	4.08	4.02	4.13	4.15	3.96	3.85
Pdesign (cooling/heating(@-10°C))	kW	5.00/4.80	2.50/3.30	3.50/3.55	2.55/3.10	3.60/3.60	4.00/4.00	5.00/4.80
Annual electricity consumption (cooling/heating)	kWh/a	286/1736	136/1133	194/1238	147/1050	207/1215	215/1416	291/1745
Designated heating season		Average						

Indoor unit		FDTC60VF
Outdoor unit		SRC60ZSX-S
Energy class (cooling/heating)		A+/A
SEER		5.76
SCOP (Average climate)		3.80
Pdesign (cooling/heating(@-10°C))	kW	5.60/5.90
Annual electricity consumption (cooling/heating)	kWh/a	341/2172
Designated heating season		Average

Multi-split System

Indoor unit		SRK15ZS-WF x 2	SRK20ZSX-W x 2	SRK20ZSX-W SRK25ZSX-W	SRK15ZS-WF x 3	SRK20ZSX-W x 3	SRK20ZSX-W x 4	SRK20ZSX-W x 5		
Outdoor unit		SCM30ZS-W	SCM40ZS-W	SCM45ZS-W	SCM41ZS-W	SCM50ZS-W	SCM60ZS-W	SCM71ZS-W	SCM80ZS-W	SCM100ZS-W
Energy class (cooling/heating)		A+++/A++	A+++/A++	A+++/A++	A+++/A++	A+++/A++	A+++/A++	A++/A++	A++/A++	A+++/A+
SEER		8.60	9.10	9.10	9.20	8.80	8.80	8.30	8.20	8.60
SCOP (Average climate)		4.80	4.70	4.70	4.60	4.60	4.60	4.60	4.60	4.50
Pdesign (cooling/heating(@-10°C))	kW	3.00/3.30	4.00/4.10	4.50/4.10	4.00/3.40	5.00/4.70	6.00/4.70	7.10/6.70	8.00/6.70	10.00/6.80
Annual electricity consumption (cooling/heating)	kWh/a	123/962	154/1222	174/1222	153/1034	199/1430	239/1430	300/2038	342/2038	407/2116
Designated heating season		Average								

Indoor unit		SRK20ZSX-W x 2	SRK20ZSX-W SRK25ZSX-W	SRK20ZSX-W x 3	SRK20ZSX-W x 4	SRK20ZSX-W x 5	SRK25ZS-W+ SRK35ZS-W x 3		
Outdoor unit		SCM40ZS-S	SCM45ZS-S	SCM50ZS-S1	SCM60ZM-S1	SCM71ZM-S1	SCM80ZM-S1	SCM100ZM-S	SCM125ZM-S*
Energy class (cooling/heating)		A++/A+	A++/A+	A++/A+	A++/A+	A++/A+	A++/A+	A/A+	-
SEER		6.31	6.43	6.80	6.80	7.20	7.10	5.10	5.61
SCOP (Average climate)		4.05	4.11	4.40	4.20	4.20	4.20	4.02	4.11
Pdesign (cooling/heating(@-10°C))	kW	4.00/3.30	4.50/4.10	5.00/4.90	6.00/7.30	7.10/8.10	8.00/8.20	10.00/10.10	-
Annual electricity consumption (cooling/heating)	kWh/a	222/1140	245/1396	258/1559	309/2435	346/2700	395/2733	687/3519	-
Designated heating season		Average							

Before starting use

Heating performance

The heating performance values (kW) described in the catalogue are the values obtained by operating at an outdoor temperature of 7°C and indoor temperature of 20°C as set forth in the ISO Standards.

Heating performance is reduced as the temperature drops. If the outdoor temperature is too low and the heating performance is insufficient, use other heating appliances as well.

Indication of sound values

The sound values are the values (A scale) measured in a chamber such as an anechoic chamber following the ISO Standards. In the actual installation state, the value is normally larger than the values given in the catalogue due to the effect of surrounding noise and echo. Take this into consideration when installing.

Use in oil atmosphere

Avoid installing this unit in an atmosphere where oil scatters or builds up, such as in a kitchen or machine factory.

If the oil adheres to the heat exchanger, the heat exchanging performance will drop, mist may be generated, and the synthetic resin parts may deform and break.

Use in acidic or alkaline atmosphere

If this unit is used in acidic atmosphere such as hot spring areas having high level of sulfuric gases or in alkaline atmosphere including ammonia or calcium chloride, places where the exhaust of the heat exchanger is sucked in, or at coastal areas where the unit is subject to salt breezes, the outer plate or heat exchanger, etc., will corrode. Please ask a dealer or specialist when you use an air-conditioner in places differing from a general atmosphere.

Use in places with high ceilings

If the ceiling is high, install a circulator to improve the heat and air flow distribution when heating.

Refrigerant leakage

The refrigerant (R32, R410A) used for air-conditioner is non-toxic and in its original state.

However, in consideration of a state where the refrigerant leaks into the room, measures against refrigerant leaks must be taken in small rooms where the tolerable level could be exceeded. Take measures by installing ventilation devices, etc.

Use in snowy areas

Take the following measures when installing the outdoor unit in snowy areas.

•Snow prevention

Install a snow-prevention hood so that the snow does not obstruct the air intake port or enter and freeze in the outdoor unit.

•Snow piling

In areas with heavy snow fall, the piled snow could block the air intake port. In this case, a frame that is 50cm or higher than the estimated snow fall must be installed underneath the outdoor unit.

Automatic defrosting device

If the temperature is low, and the humidity is high, frost will stick to the heat exchanger of the outdoor unit. If continued to use, the heating performance will drop.

The "Automatic defrosting device" will function to remove this frost.

After heating for approx. three to ten minutes, it will stop, and the frost will be removed. After defrosting, hot air will be blown again.

Servicing

After the air-conditioner has been used for several seasons, dirt will build up in the air-conditioner causing the performance to drop. In addition to regular servicing, a maintenance contract by a specialist is recommended.

Safety Precautions

Air-conditioner usage target

The air-conditioner described in this catalogue is a dedicated cooling/heating device for human use.

Do not use it for special applications such as the storage of food items, animals or plants, precision devices or valuable art, etc.

This could cause the quality of the items to drop, etc.

Do not use this for cooling vehicles or ships. Water leakage or current leaks could occur.

Before use

Always read the "User's Manual" thoroughly before starting use.

Installation

Always commission the installation to a dealer or specialist. Improper installation will lead to water leakage, electric shocks and fires.

Make sure that the outdoor unit is stable in installation. Fix the unit to stable base.

Usage place

Do not install in places where combustible gas could leak or where there are sparks.

Installation in a place where combustible gas could be generated, flow or accumulate, or places containing carbon fibers could lead to fires.

Certified ISO 9001



Mitsubishi Heavy Industries - Mahajak Air Conditioners Co., Ltd. has been certified of Quality Management System in accordance with ISO 9001 by TUV NORD (Thailand) Ltd.

Certified ISO 14001



Mitsubishi Heavy Industries - Mahajak Air Conditioners Co., Ltd. has been certified of Environmental Management System in accordance with ISO 14001 by TUV NORD (Thailand) Ltd.



Mitsubishi Heavy Industries Thermal Systems, Ltd. Participate in the Eurovent certification program for variable refrigerant flow (AC1 & AC2). Check ongoing validity of certificate: www.eurovent-certification.com



Mitsubishi Heavy Industries Thermal Systems, Ltd.

(Wholly-owned subsidiary of MITSUBISHI HEAVY INDUSTRIES, LTD.)

2-3, Marunouchi 3-chome, Chiyoda-ku, Tokyo, 100-8332, Japan

<https://www.mhi-mth.co.jp/en/>

Because of our policy of continuous improvement, we reserve the right to make changes in all specifications without notice.

26R01E December 2025 F Edited in Japan